





**MOSQUITOES**

**SEC. NO:-3751**

**Weight :- 2.000kg/12'**

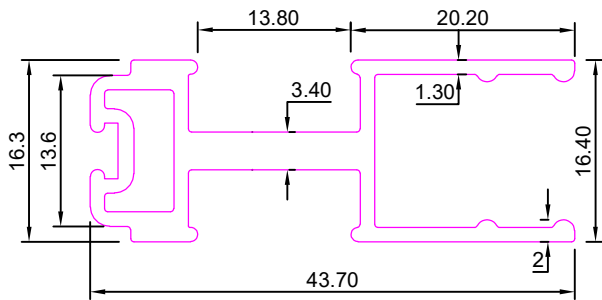

**SEC. NO:-3753**

**Weight :- 0.445kg/12'**

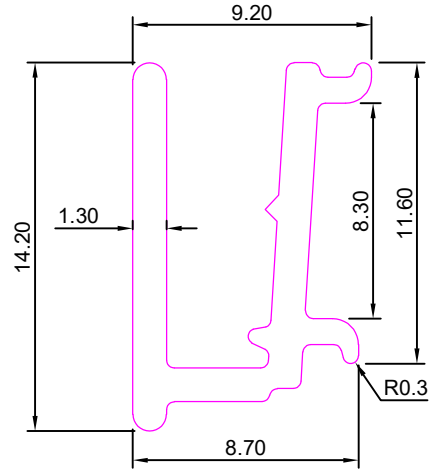

**SEC. NO:-3755**

**Weight :- 2.190kg/12'**

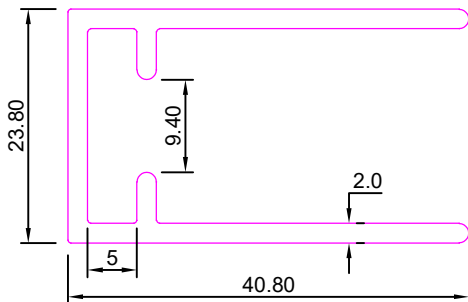

**SEC. NO:-3757**

**Weight:- 1.250kg/12'**

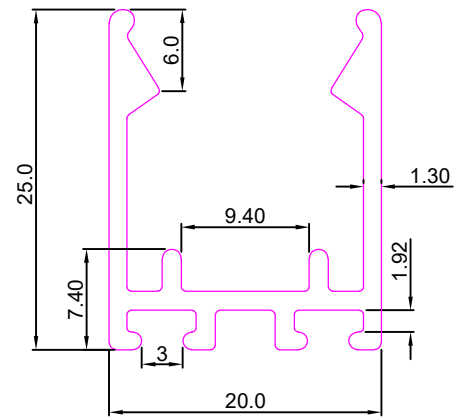

**SEC No. 7328**

**Weight :-2.720kg/12'**

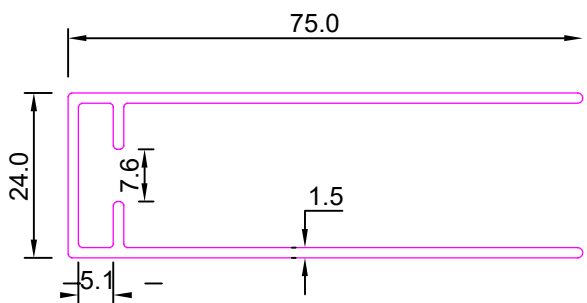

**SEC No. 7331**

**Weight :- 1.400kg/12'**

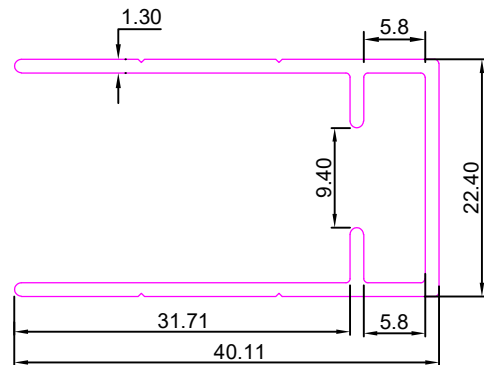



**MOSQUITOES**

**SEC No. 7332**

**Weight :-0.755kg/12'**

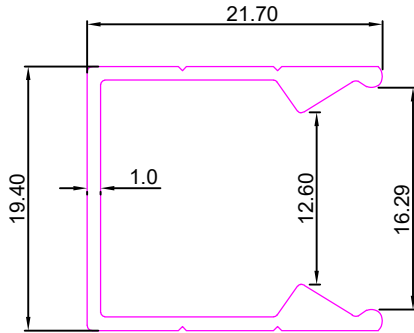

**SEC No. 7365**

**Weight :-1.650kg/12'**

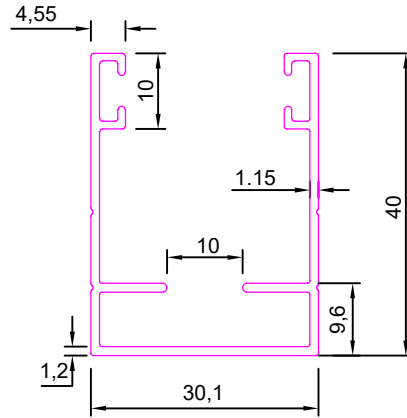

**SEC. NO:-7574**

**Weight :-1.916kg/12'**

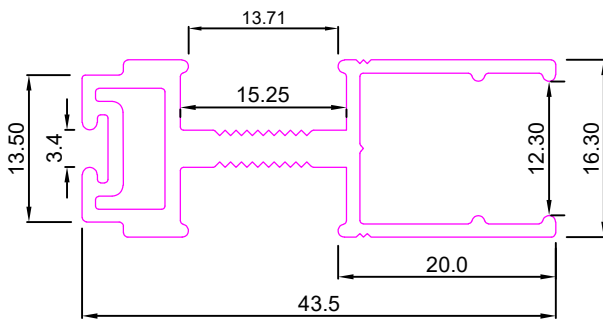

**SEC No. 7855**

**Weight:-1.765Kg/12'**

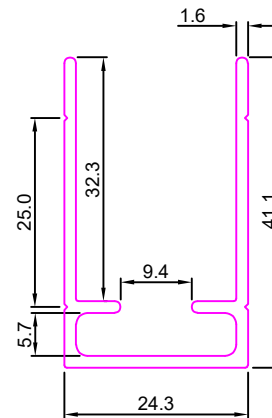

**SEC No. 7960**

**Weight:-1.895Kg/12'**

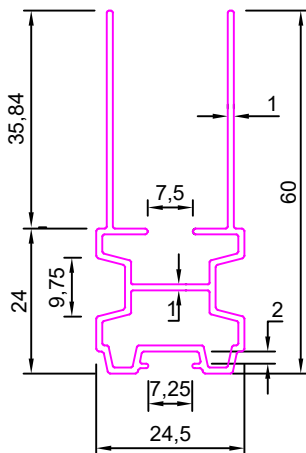

**SEC No. 7961**

**Weight:-1.575Kg/12'**

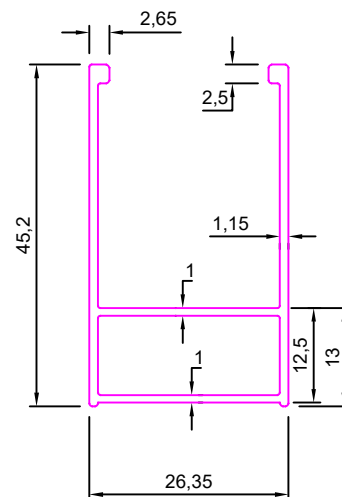



**MOSQUITOES**

**SEC No. GA8224**

**Weight:-1.625Kg/12'**

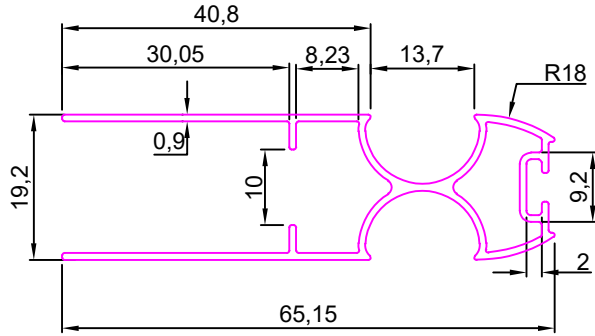

**SEC No. GA8225**

**Weight:-1.050Kg/12'**

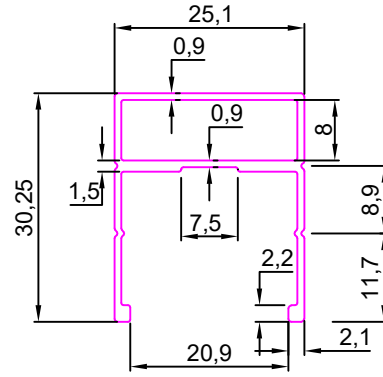

**SEC No. GA8226**

**Weight:-1.100Kg/12'**

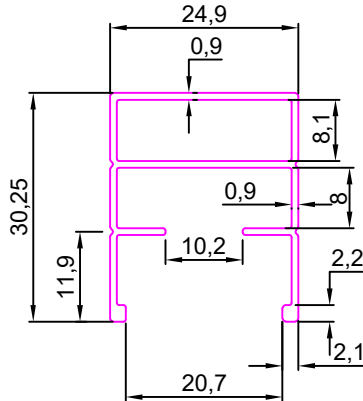

**SEC No. 8389**

**Weight:-1.810Kg/12'**

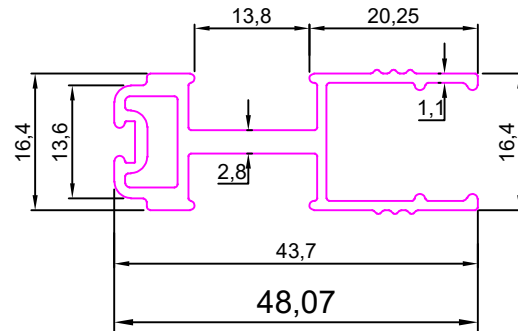

**SEC No. 8390**

**Weight:-1.650Kg/12'**

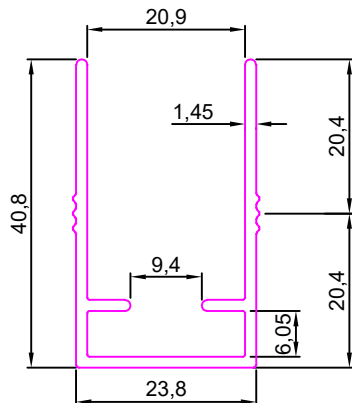

**SEC No. 8391**

**Weight:-1.200Kg/12'**

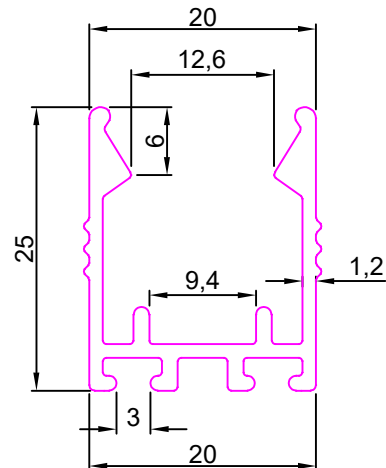



**MOSQUITOES**

**SEC No. 8392**

**Weight:-0.450Kg/12'**

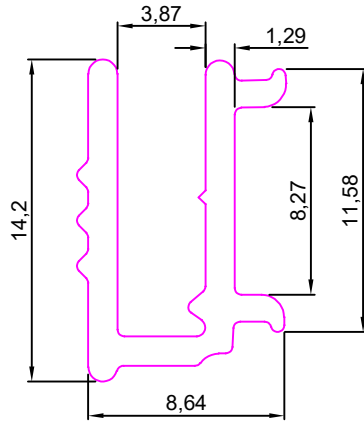

**SEC No. 8481**

**Weight:-1.000Kg/12'**

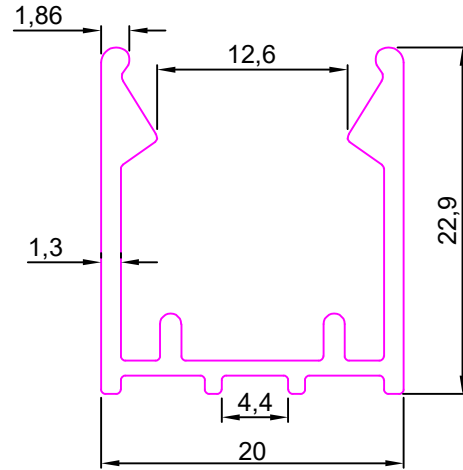

**SEC No. 8736**

**Weight:-1.750Kg/12'**

