

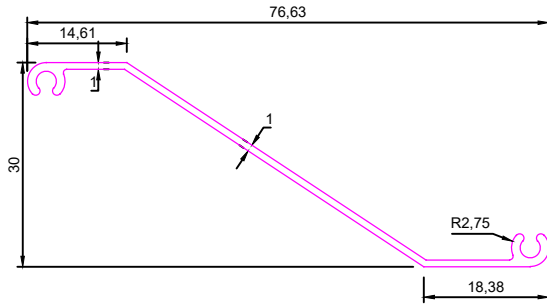

LOUVERS

SEC. NO:- 5201

Weight :- 1.035g/12'



SEC. NO:- 5203

Weight :- 1.520kg/12'

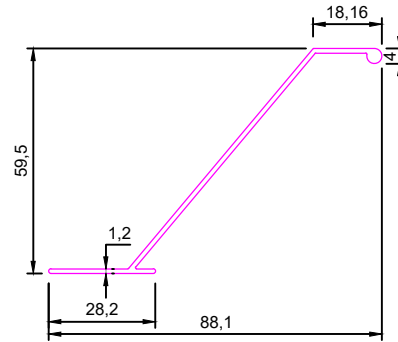

SEC. NO:- 5205

Weight :- 0.880kg/12'

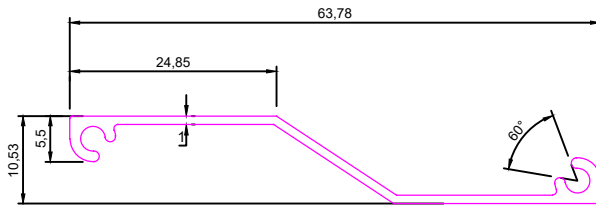

SEC. NO:- 5207

Weight :- 1.140kg/12'

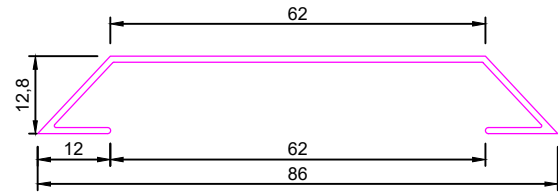

SEC. NO:- 5209

Weight :- 2.150kg/12'

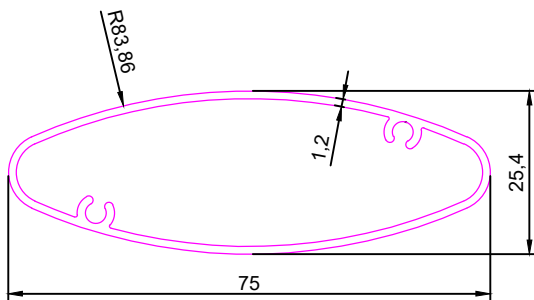

SEC. NO:- 5211

Weight :- 1.565kg/12'

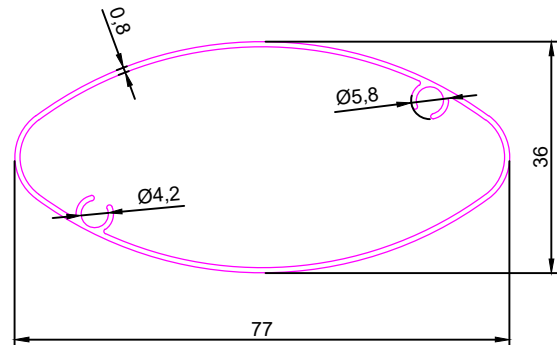



LOUVERS

SEC. NO:- 5213

Weight :- 2.735kg/12'

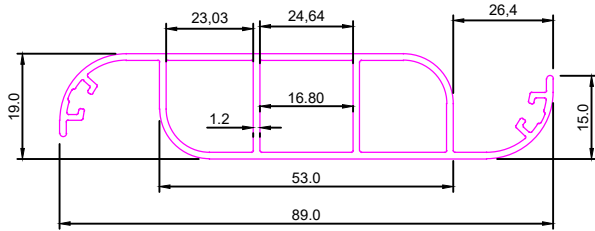

SEC. NO:- 5215

Weight :- 2.100kg/12'

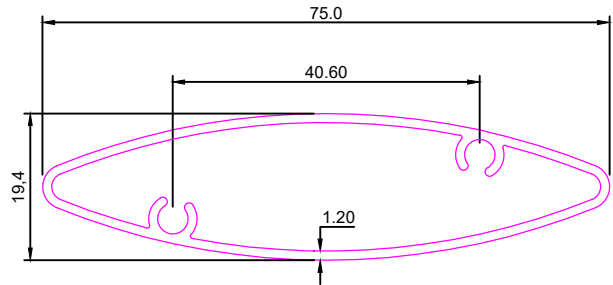

SEC. NO:- 5217

Weight :- 2.945kg/12'

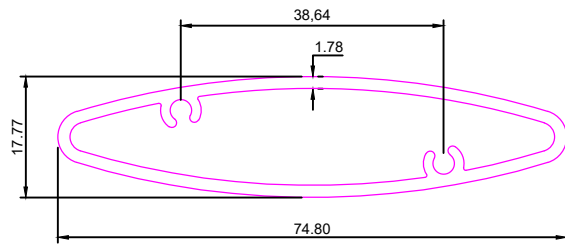

SEC. NO:- 5219

Weight :- 2.715kg/12'

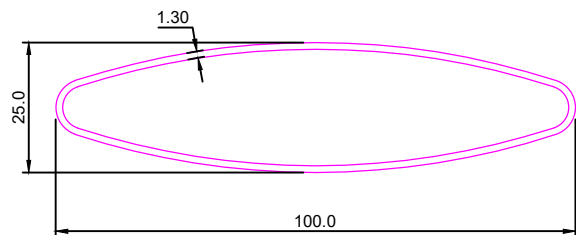

SEC. NO:- 5221

Weight :- 2.955kg/12'

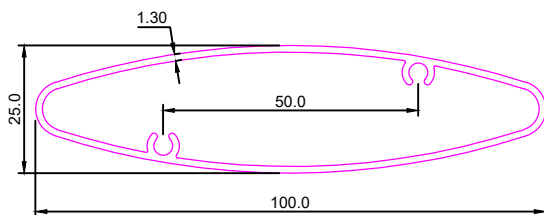

SEC. NO:- 5223

Weight :-6.420kg/12'

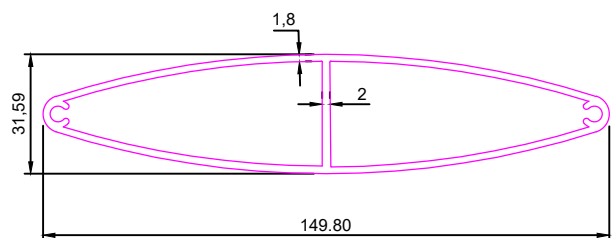



LOUVERS

SEC. NO:- 5225

Weight :-2.075kg/12'

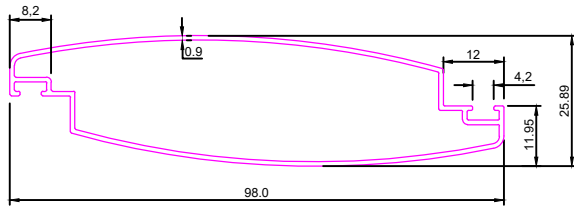

SEC. NO:- 5227

Weight :-2.240kg/12'

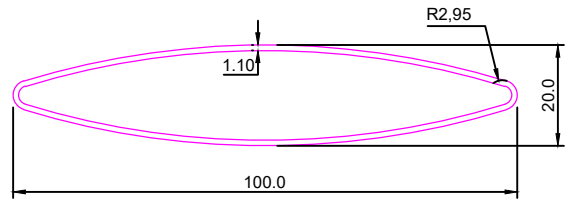

SEC. NO:- 5229

Weight :-2.955kg/12'

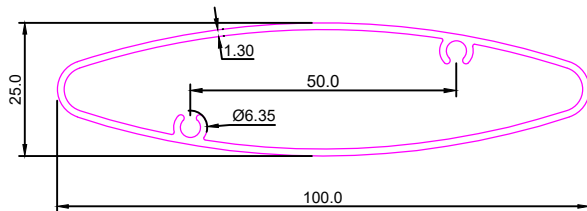

SEC. NO:- 5231

Weight :-1.570kg/12'

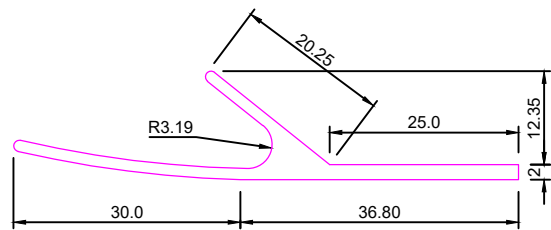

SEC. NO:- 5233

Weight :-2.655kg/12'

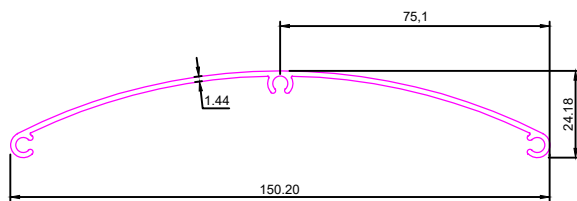

SEC. NO:-7021/1

Weight :- 3.820kg/12'

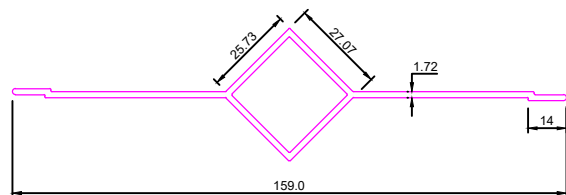



LOUVERS

SEC No. 7317

Weight :-3.280kg/12'

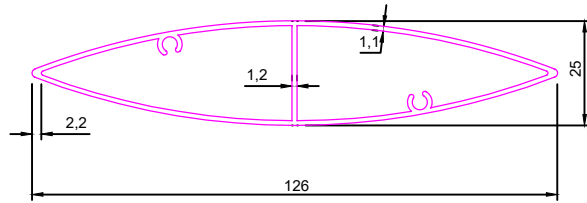

SEC No.7376

Weight :-5.500kg/12'

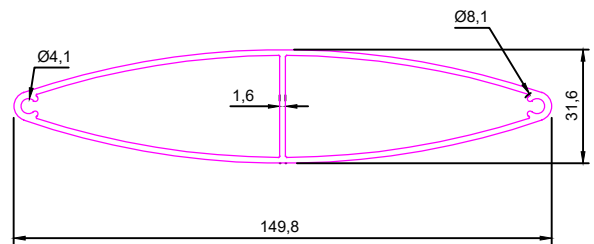

SEC No. 7358

Weight :-10.635kg/12'

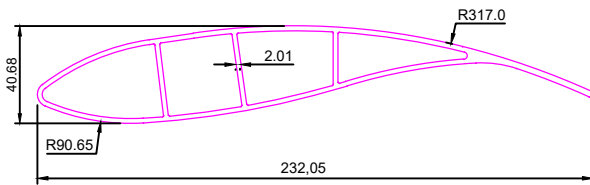

SEC No. 7413

Weight :-1.000kg/12'

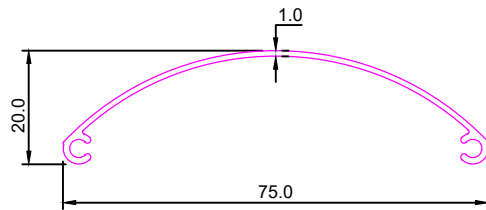

SEC No. 7427

Weight :-5.475kg/12'

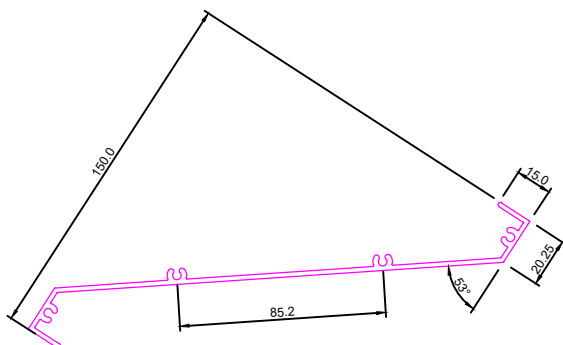

SEC No. 7467

Weight :-2.574kg/12'

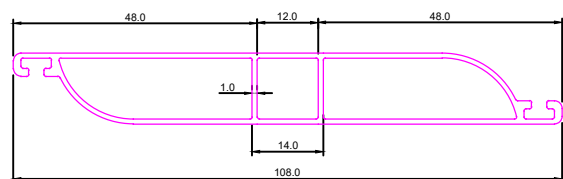



LOUVERS

SEC No. 7468

Weight :-9.500kg/12'

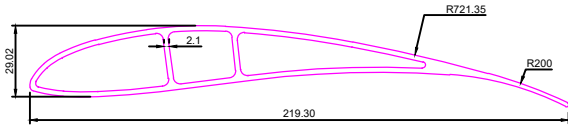

SEC. NO:-7568

Weight :- 1.650kg/12'

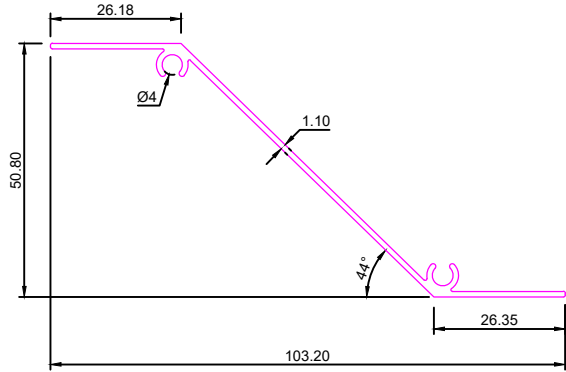

SEC. NO:-7578

Weight :- 1.200kg/12'

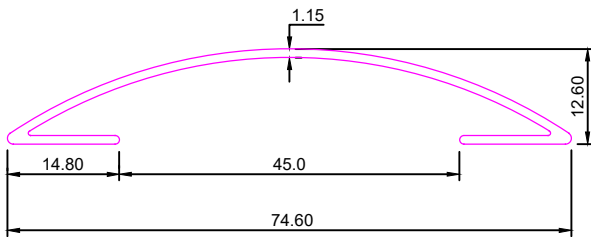

SEC No. 7620

Weight :-20.400kg/12'

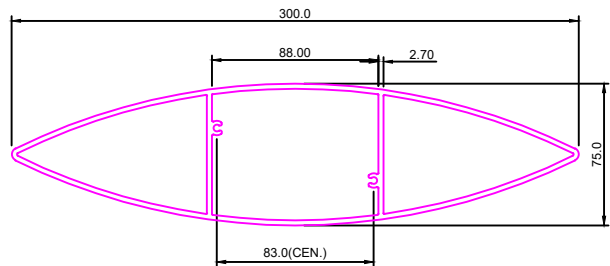

SEC No. 7734

Weight:-3.250Kg/12'

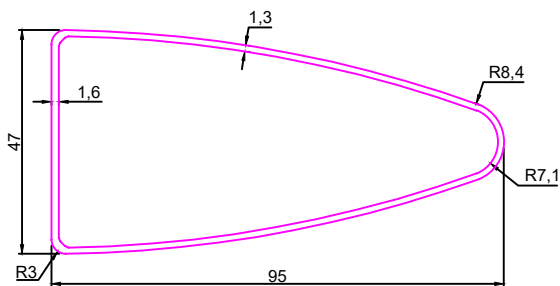

SEC No. 7739

Weight:-5.500Kg/12'

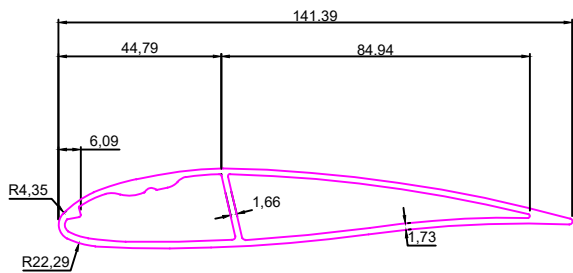



LOUVERS

SEC No. 7821

Weight:-8.200Kg/12'

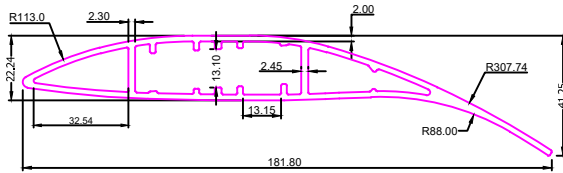

SEC No. MA7968

Weight:-9.200Kg/12'

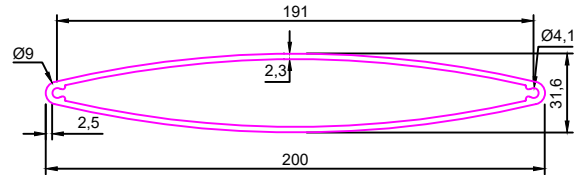

SEC No:-GA8078

Weight:-8.050Kg/12'

