

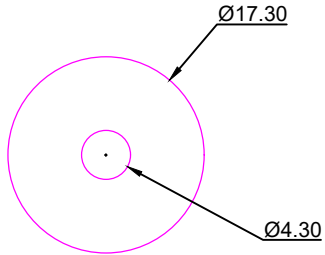

INDUSTRIAL

SEC NO. 1681

Weight:-2.180kg/12'



SEC NO. :-1691

Weight-1.650kg/12'

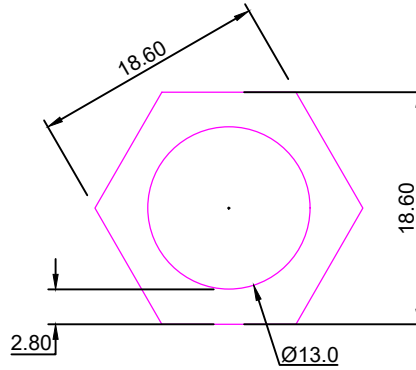

SEC NO. :-1701

Weight-1.530kg/12'

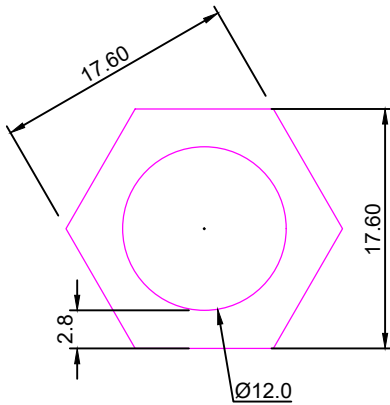

SEC NO. :-1801

Weight-0.900kg/12'

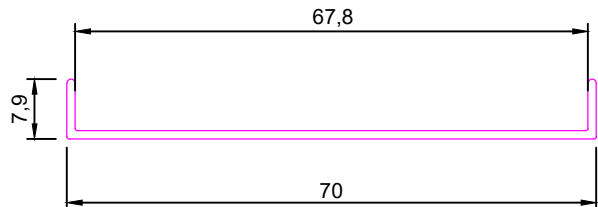

SEC NO. :-1803

Weight-2.775kg/12'

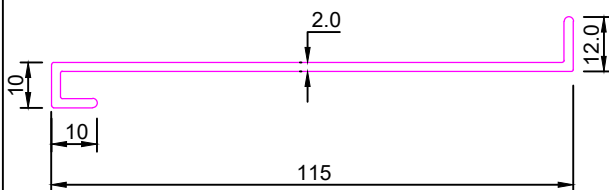

SEC NO. :-1805

Weight-2.145kg/12'

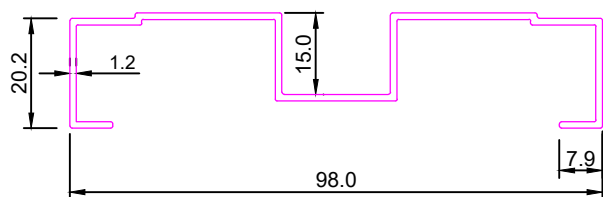



INDUSTRIAL

SEC NO. :-1807

Weight-1.450kg/12'

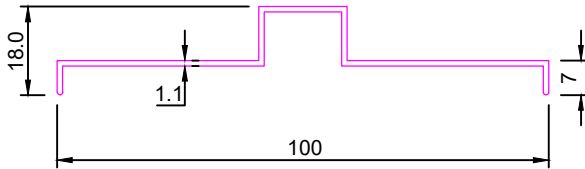

SEC NO. :-1809

Weight-1.755kg/12'

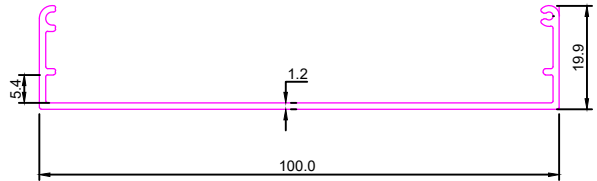

SEC NO. :-1811

Weight-4.300kg/12'

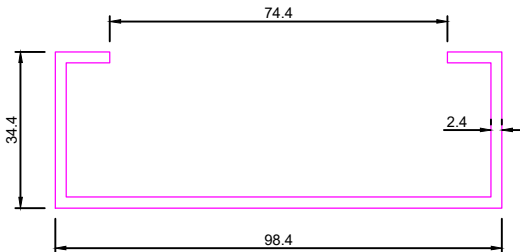

SEC NO. :-1813

Weight-2.280kg/12'

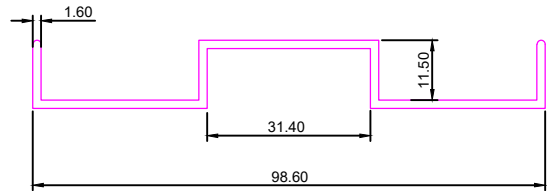

SEC NO. :-1815

Weight-2.785kg/12'

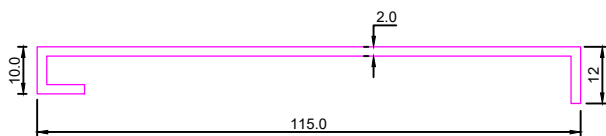

SEC NO. :-1817

Weight-3.500kg/12'

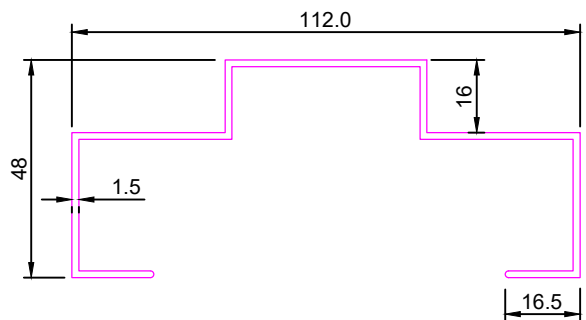



INDUSTRIAL

SEC NO. :-1819

Weight-6.735kg/12'

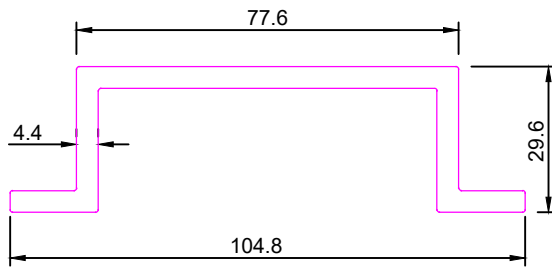

SEC NO. :-1821

Weight-0.460kg/12'

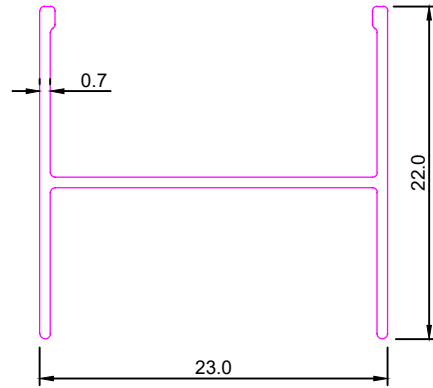

SEC NO. :-1823

Weight-0.790kg/12'

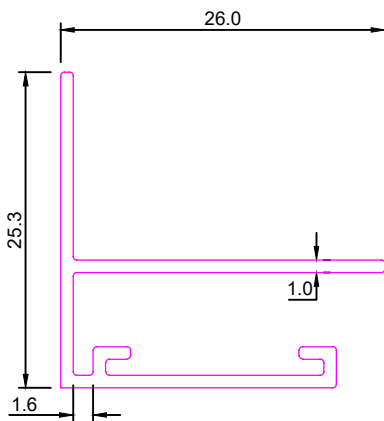

SEC NO. :-1825

Weight-.365kg/12'

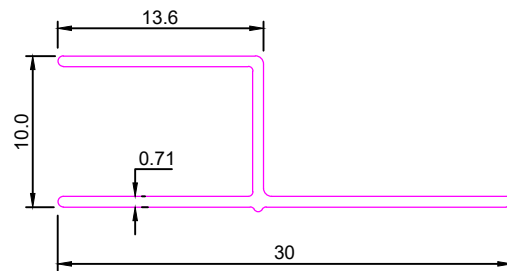

SEC NO. :-1827

Weight-0.725kg/12'

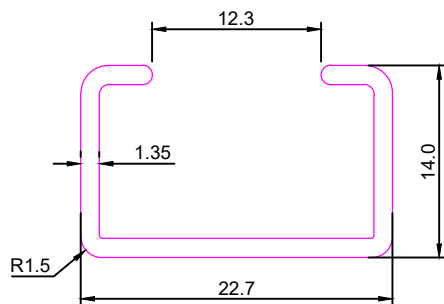

SEC NO. :-1829

Weight-0.765kg/12'

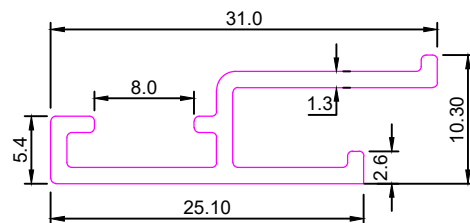



INDUSTRIAL

SEC NO. :-1831

Weight-0.720kg/12'

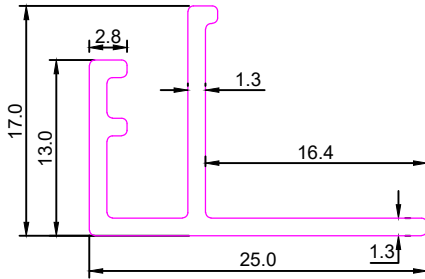

SEC NO. :-1833

Weight-0.670kg/12'

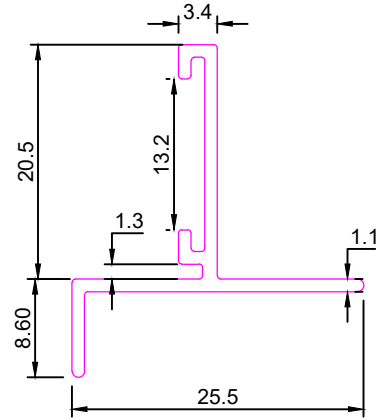

SEC NO. :-1835

Weight-0.860kg/12'

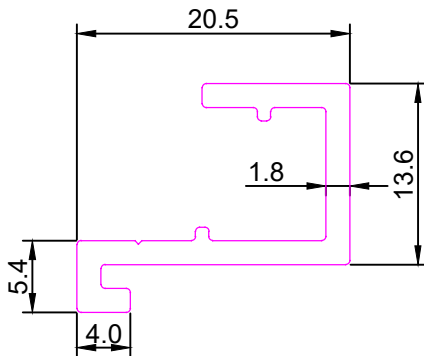

SEC NO. :-2021

Weight-3.050kg/12'

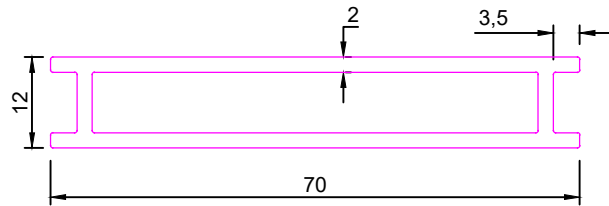

SEC NO. :-2120

Weight-1.050kg/12'

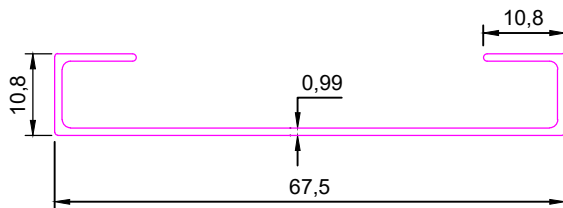

SEC NO. :-6001

Weight-17.035kg/12'

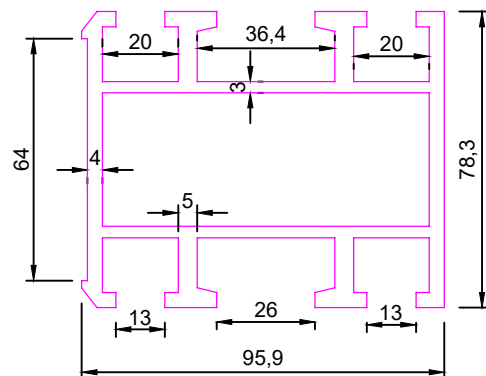



INDUSTRIAL

SEC NO. :-6003

Weight-10.270kg/12'

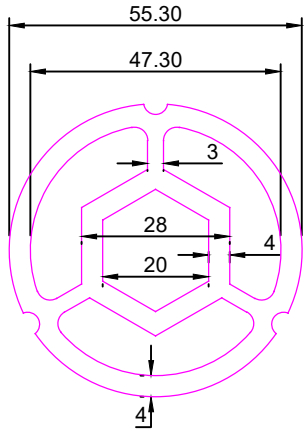

SEC NO. :-6005

Weight-13.825kg/12'

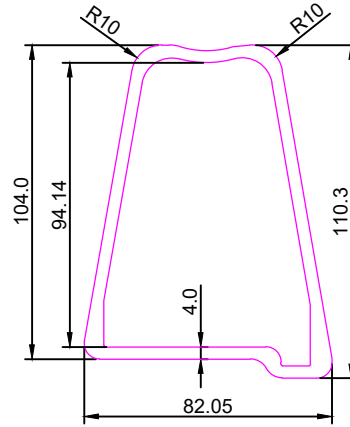

SEC NO. :-6007

Weight-1.920kg/12'

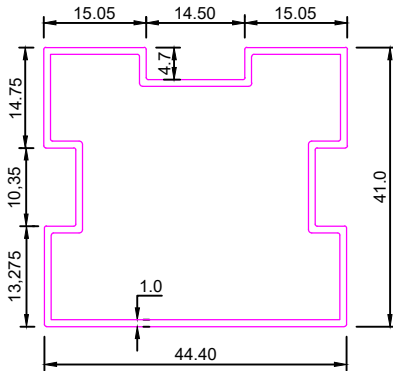

SEC NO. :-6009

Weight-2.665kg/12'

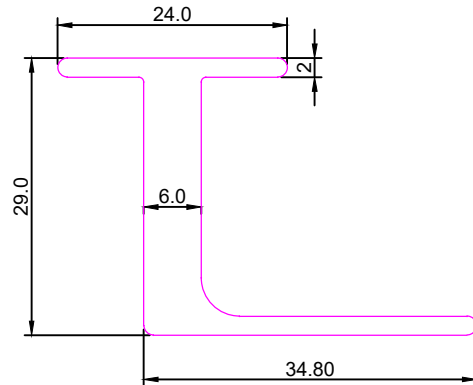

SEC NO. :-6011

Weight-1.650kg/12'

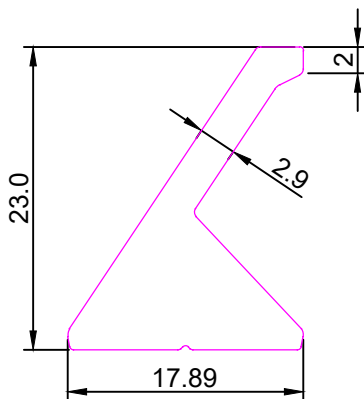

SEC. NO:- 6013

Weight-2.045kg/12'

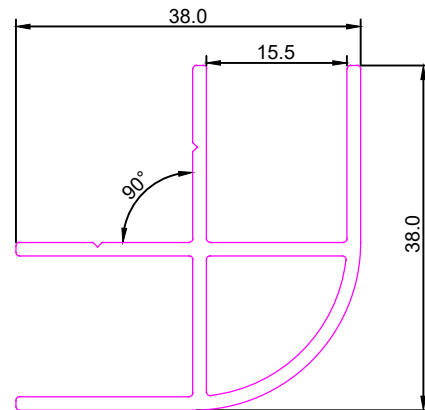



INDUSTRIAL

SEC NO. :-6015

Weight-1.310kg/12'

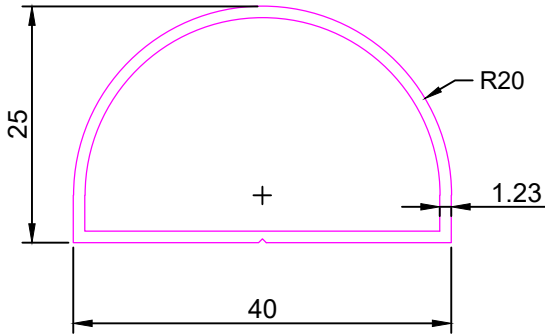

SEC NO. :-6017

Weight-4.890kg/12'

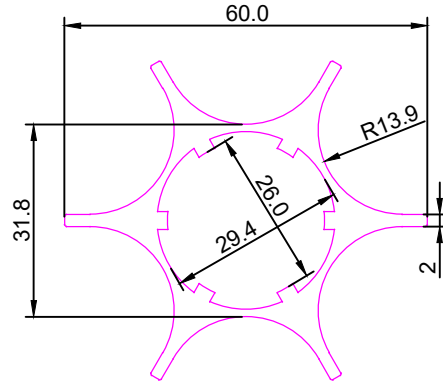

SEC. NO:- 6019

Weight :- 1.675kg/12'

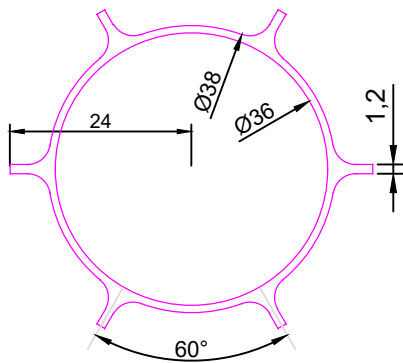

SEC. NO:- 6021

Weight :- 2.025kg/12'

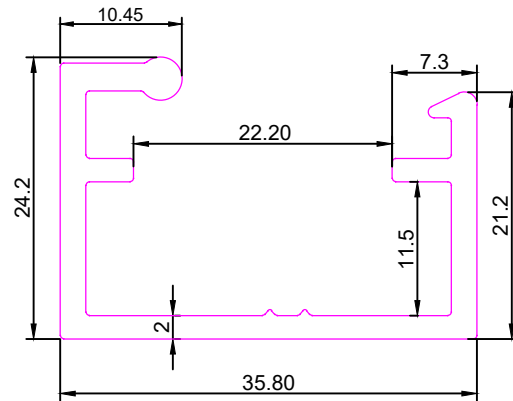

SEC. NO:- 6023

Weight :- 0.533kg/12'

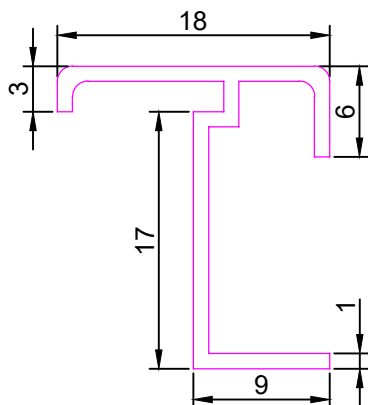

SEC. NO:- 6025

Weight :- 2.725kg/12'

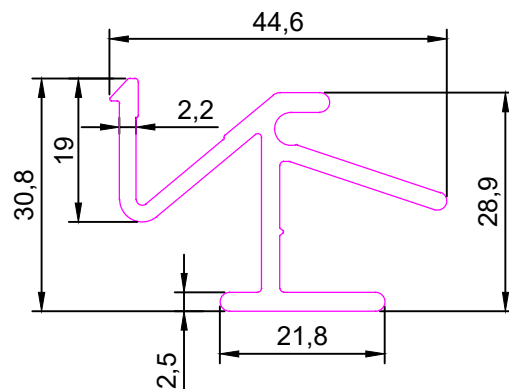



INDUSTRIAL

SEC. NO:- 6027

Weight :-1.035kg/12'

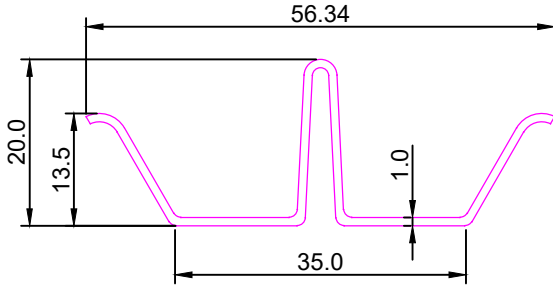

SEC. NO:- 6029

Weight :- 2.190kg/12'

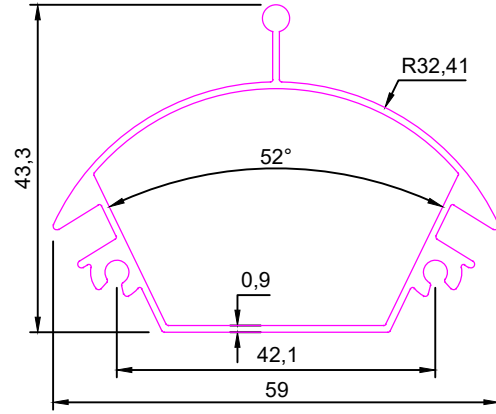

SEC. NO:- 6031

Weight :-2.055kg/12'

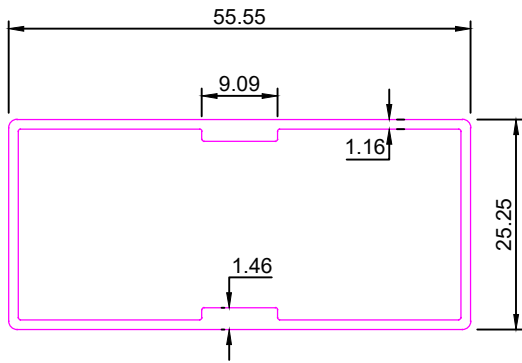

SEC. NO:- 6033

Weight :-2.180kg/12'

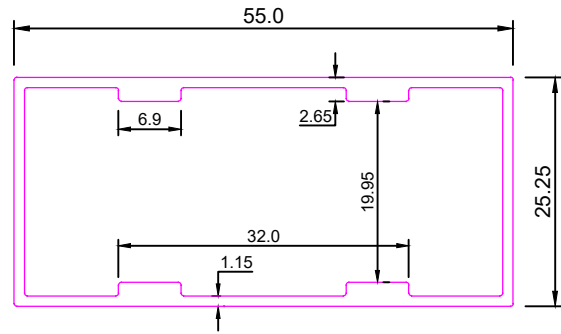

SEC. NO:- 6035

Weight :-3.035kg/12'

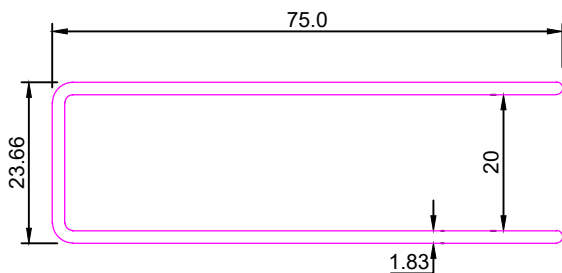

SEC. NO:- 6037

Weight :-5.390kg/12'

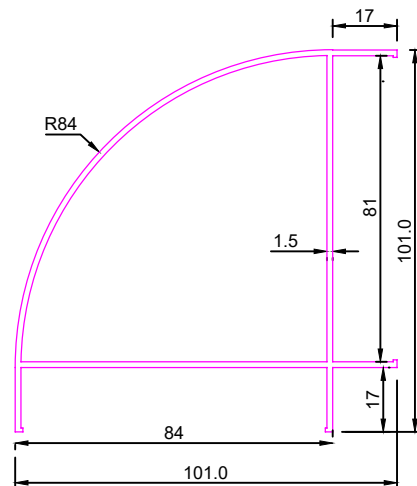



INDUSTRIAL

SEC. NO:- 6041

Weight :- 3.610kg/12'

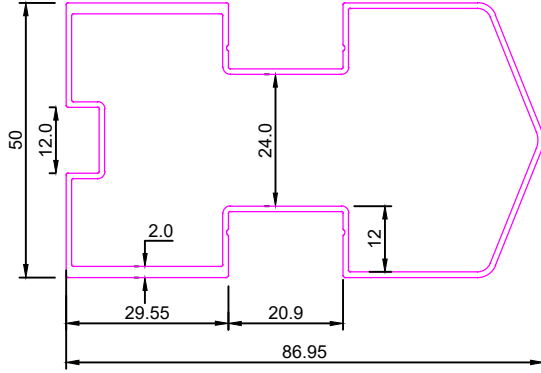

SEC. NO:-6043

Weight :- 2.915kg/12'

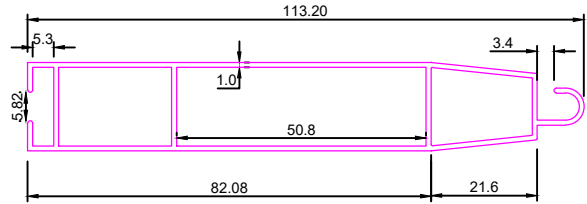

SEC. NO:-6045

Weight :- 2.895kg/12'

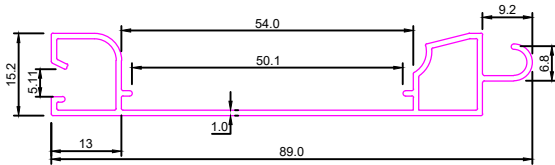

SEC. NO:-6047

Weight :- 6.115kg/12'

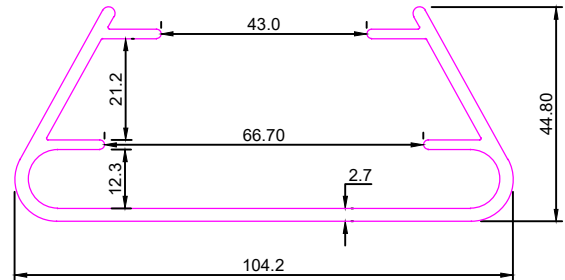

SEC. NO:-6049

Weight :- 1.370kg/12'

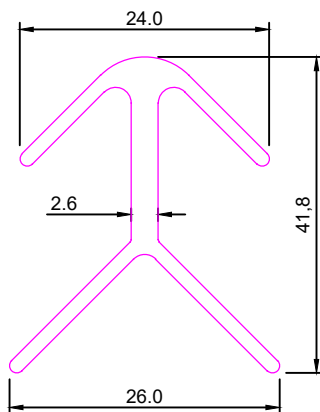

SEC. NO:-6051

Weight :- 2.320kg/12'

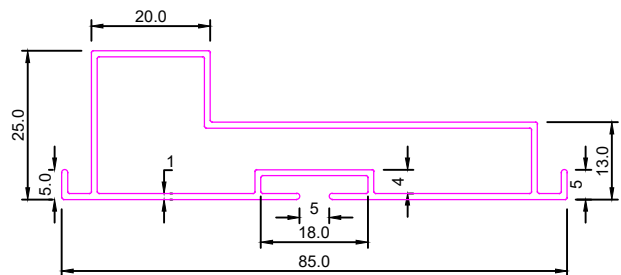



INDUSTRIAL

SEC. NO:-6053

Weight :- 0.656kg/12'

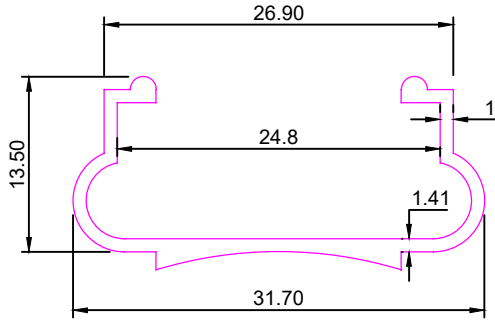

SEC. NO:-6055

Weight :- 3.080kg/12'

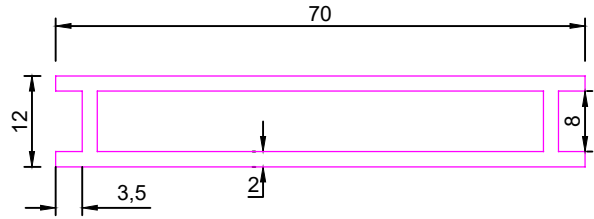

SEC. NO:-6057

Weight :- 0.440kg/12'

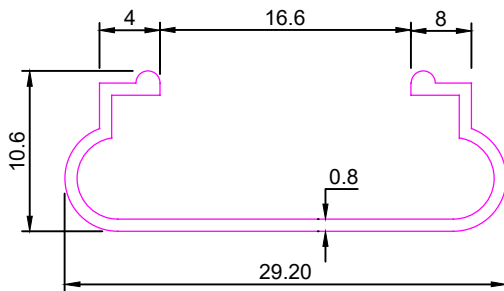

SEC. NO:-6059

Weight :- 1.325kg/12'

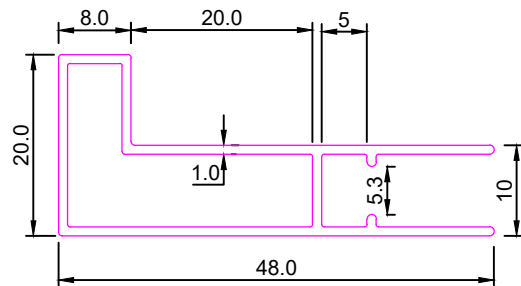

SEC. NO:-6061

Weight :- 1.895kg/12'

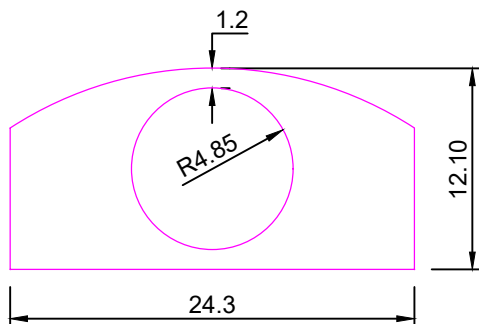

SEC. NO:-6063

Weight :- 1.350kg/12'

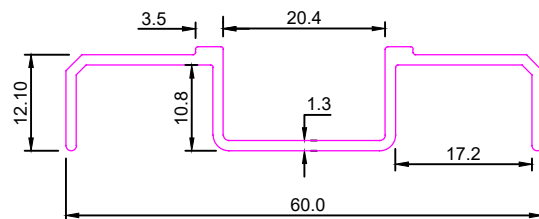



INDUSTRIAL

SEC. NO:-6065

Weight :- 1.210kg/12'

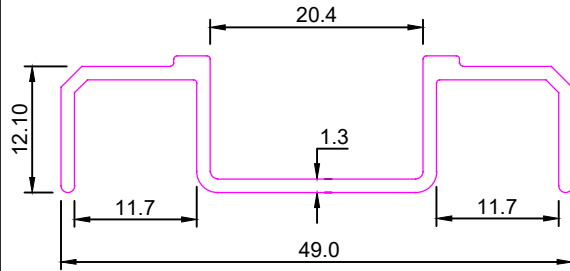

SEC. NO:-6067

Weight :- 1.580kg/12'

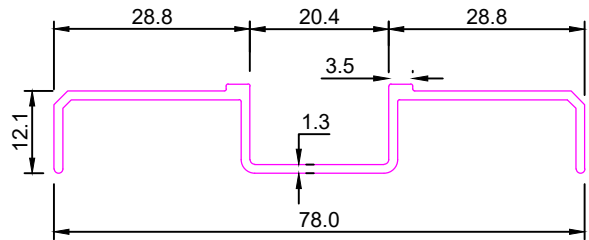

SEC. NO:-6069

Weight :- 1.920kg/12'

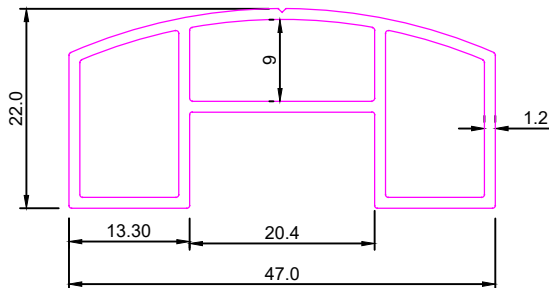

SEC. NO:-6071

Weight :- 2.300kg/12'

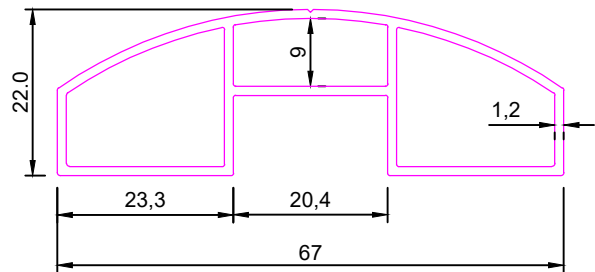

SEC. NO:-6073

Weight :- 1.320kg/12'

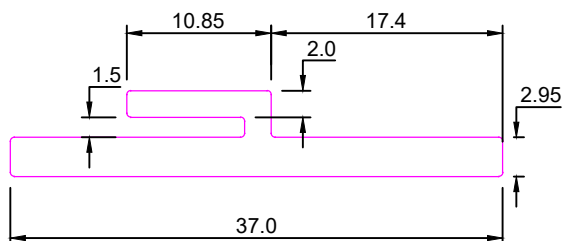

SEC. NO:-6079

Weight :- 1.545kg/12'

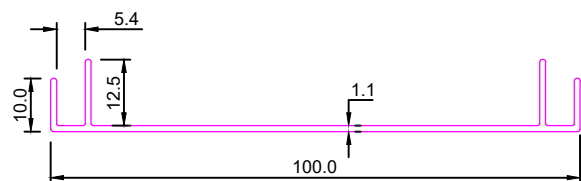



INDUSTRIAL

SEC. NO:-6081

Weight :- 4.660kg/12'

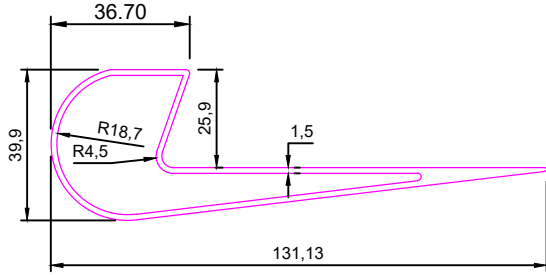

SEC. NO:-6083

Weight :- 0.800kg/12'

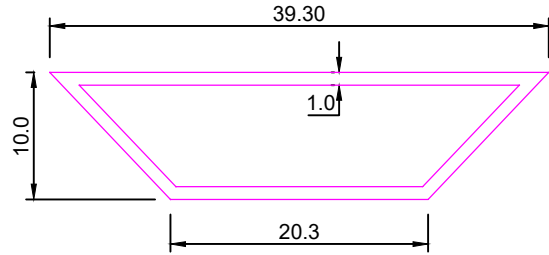

SEC. NO:-6085

Weight :- 0.865kg/12'

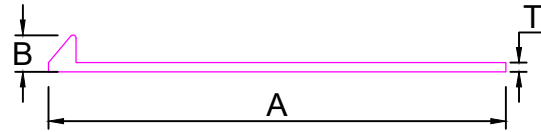
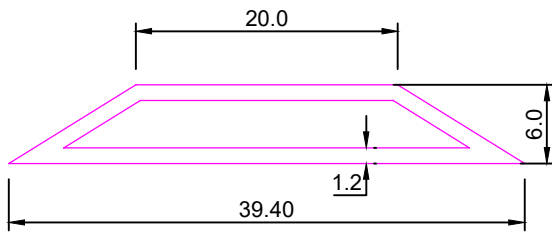

SEC. NO.	A	B	T	Wt (Kg./mtr.)	Weight KG/12'
6085	64.80	3.50	0.8	1.0	0.550-0.650
6086	79.75	3.50	0.8	0.186	0.670-0.800
6087	97.60	3.50	0.8	0.224	0.830-0.980

SEC. NO:-6095

Weight :- 6.630kg/12'

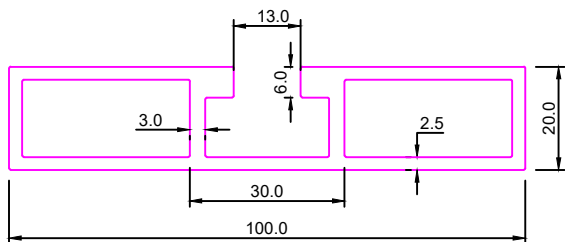

SEC. NO:-6097

Weight :- 13.125kg/12'

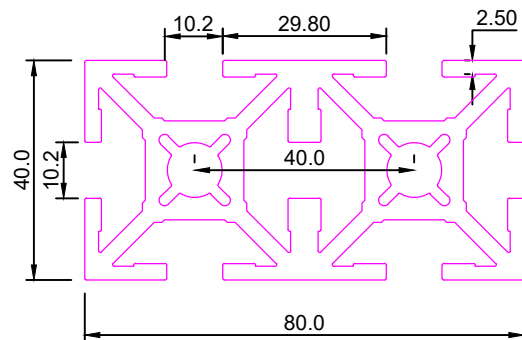



INDUSTRIAL

SEC. NO:-6099

Weight :- 6.560kg/12'

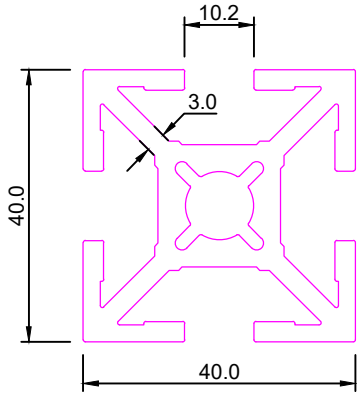

SEC. NO:-7001

Weight :- 3.145kg/12'

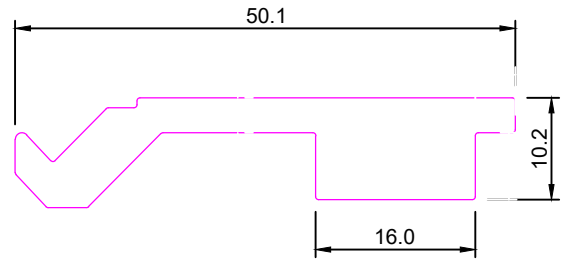

SEC. NO:-7003

Weight :- 2.920kg/12'

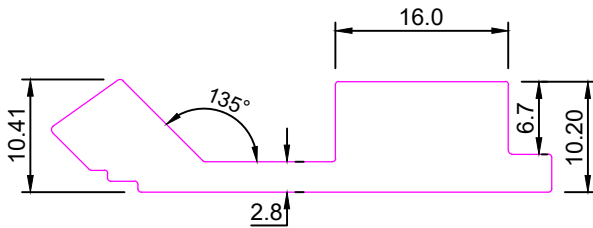

SEC. NO:-7005

Weight :- 20.870kg/12'

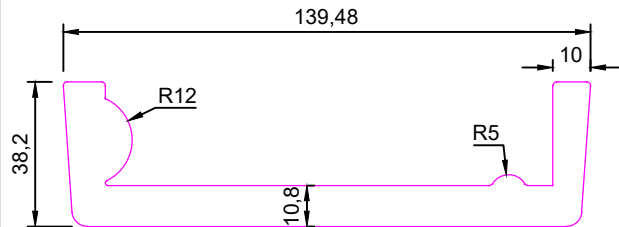

SEC. NO:-7007

Weight :- 24.965kg/12'

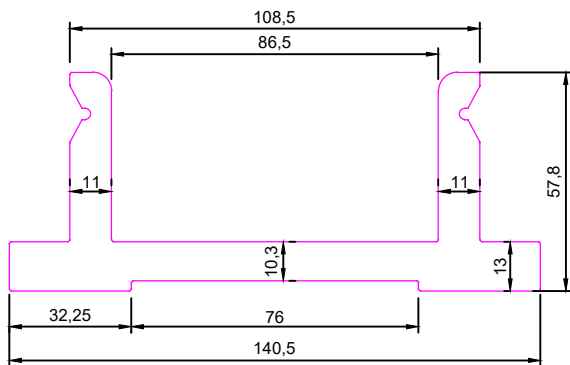

SEC. NO:-7009

Weight :- 6.850-7.100kg/12'

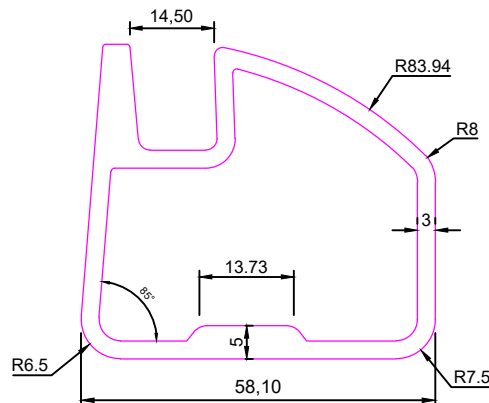



INDUSTRIAL

SEC No. :-7010

Weight:-14.750Kg/12'

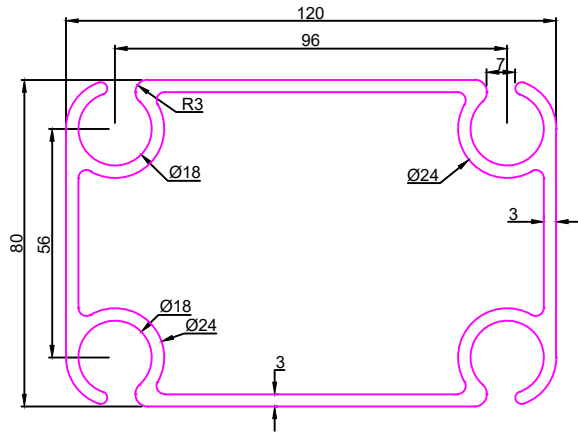

SEC. NO:-7011/1

Weight :- 9.160kg/12'

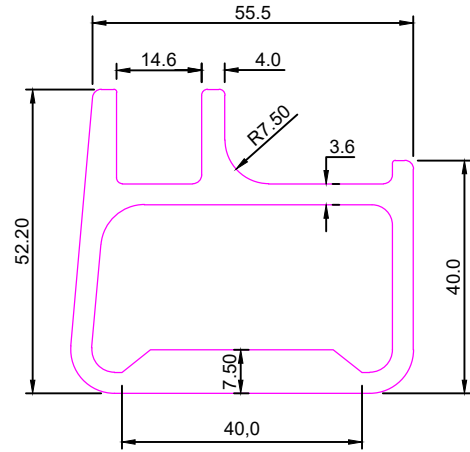

SEC No. 7011/2

Weight :- 1.460kg/12'

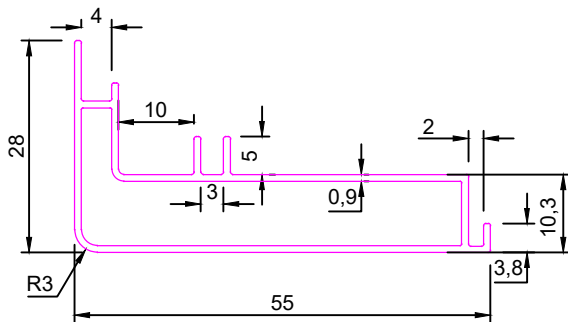

SEC. NO:-7013

Weight :- 6.320kg/12'

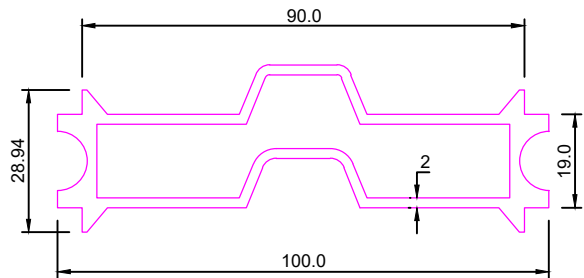

SEC. NO:-7015

Weight :- 10.680kg/12'

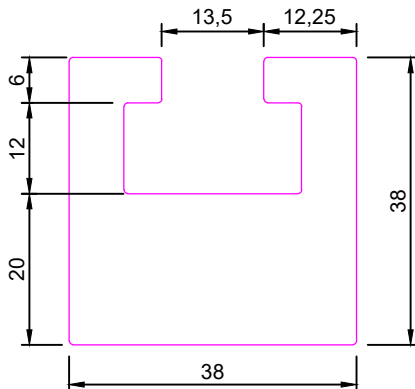

SEC. NO:-7017

Weight :- 9.190kg/12'

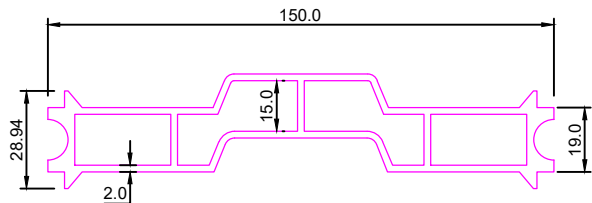



INDUSTRIAL

SEC No. 7018

Weight :- 6.055kg/12'

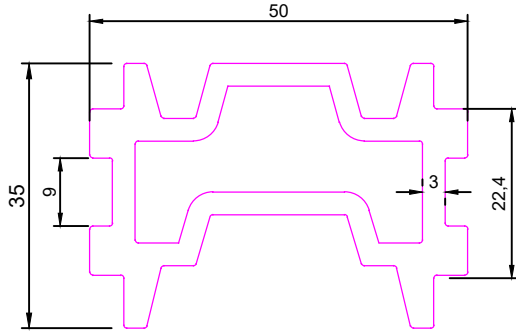

SEC. NO:-7019

Weight :- 1.080kg/12'

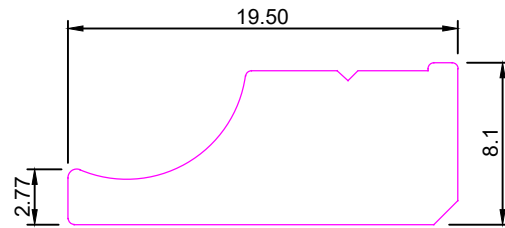

SEC No. 7070

Weight :- 1.315kg/12'

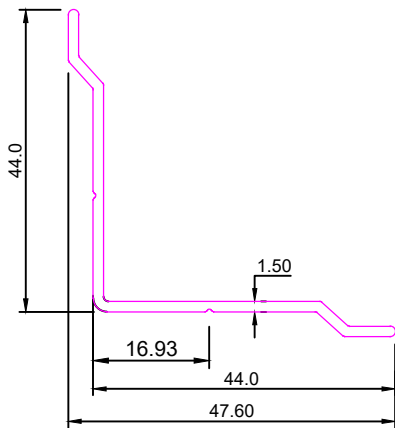

SEC No. 7071

Weight :- 3.125kg/12'

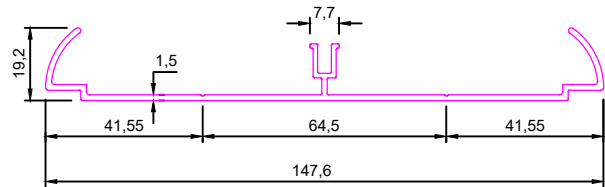

SEC No. 7072

Weight :- 4.390kg/12'

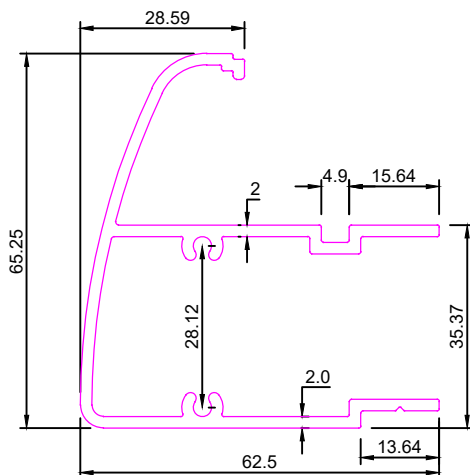

SEC No. 7073

Weight :- 2.800kg/12'

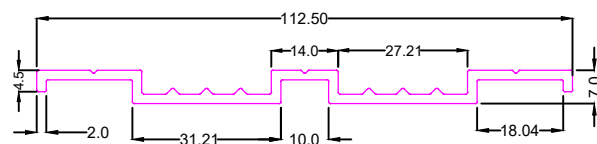



INDUSTRIAL

SEC No. 7074

Weight :- 3.125kg/12'

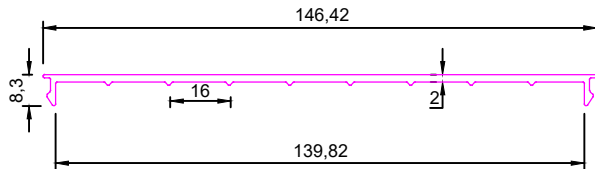

SEC No. 7110

Weight :- 4.460kg/12'

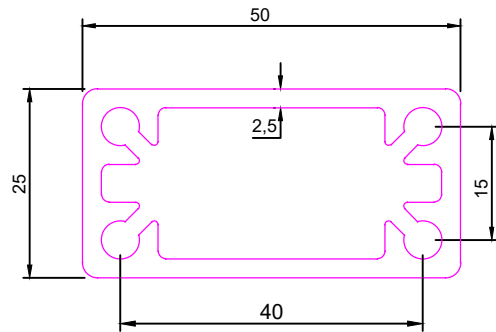

SEC No. 7111

Weight :- 8.695kg/12'

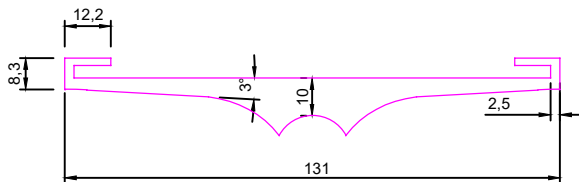

SEC No. 7112

Weight :- 8.365kg/12'

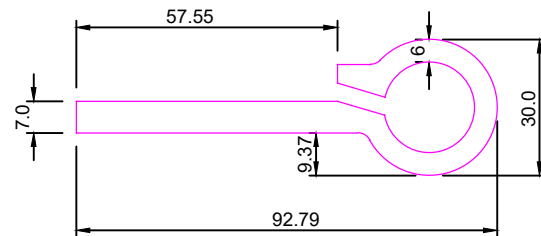

SEC No. 7113

Weight :- 4.400kg/12'

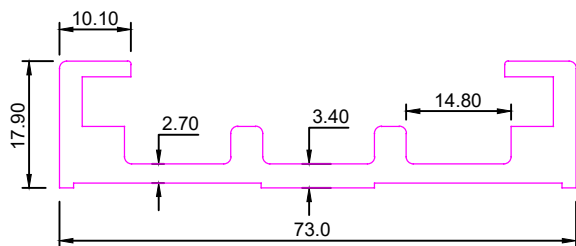

SEC No. 7123

Weight :-1.200kg/12'

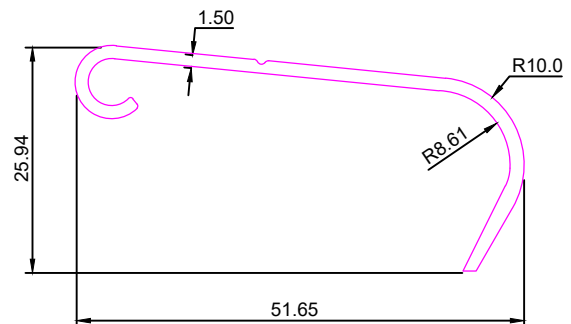



INDUSTRIAL

SEC No. 7124

Weight :- 2.620kg/12'

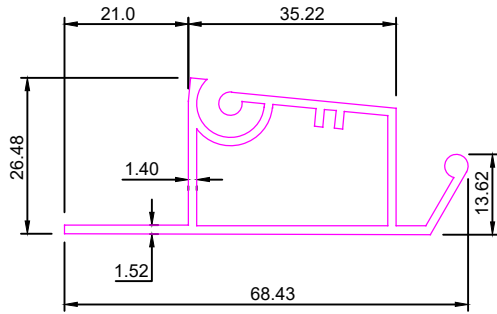

SEC No. 7125

Weight :- 2.160kg/12'

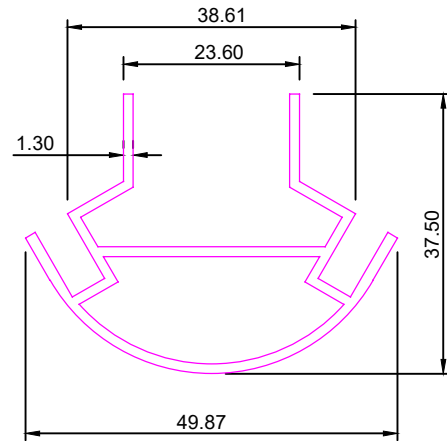

SEC No. 7126

Weight :- 2.210kg/12'

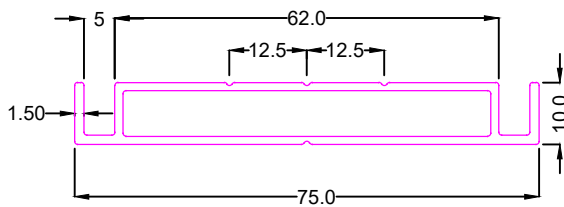

SEC No. 7127

Weight :- 4.395kg/12'

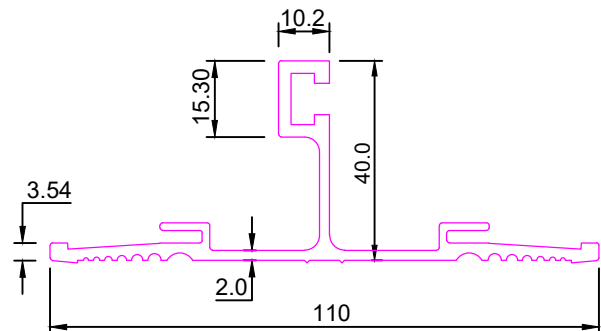

SEC No. 7139

Weight :- 19.000kg/12'

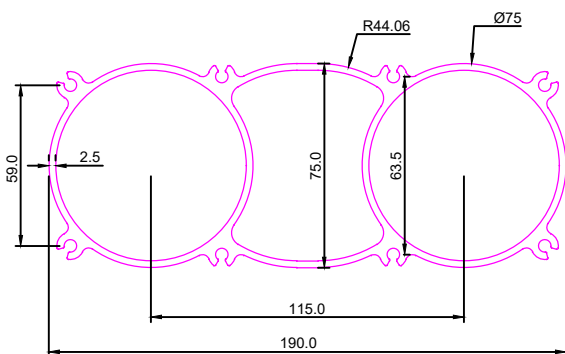

SEC No. 7140

Weight :- 47.290kg/12'

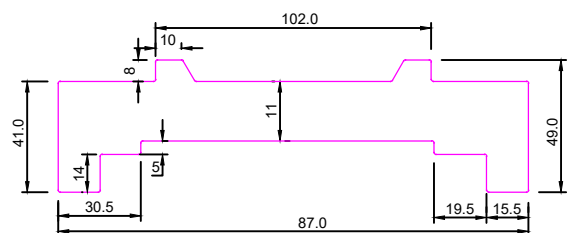



INDUSTRIAL

SEC No. 7141

Weight :- 55.600kg/12'

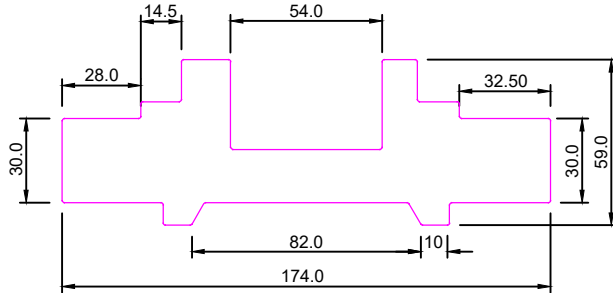

SEC No. 7142

Weight :- 15.100kg/12'

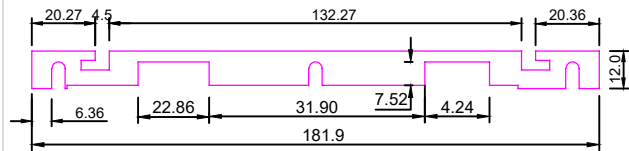

SEC No. 7150

Weight :- 46.615kg/12'

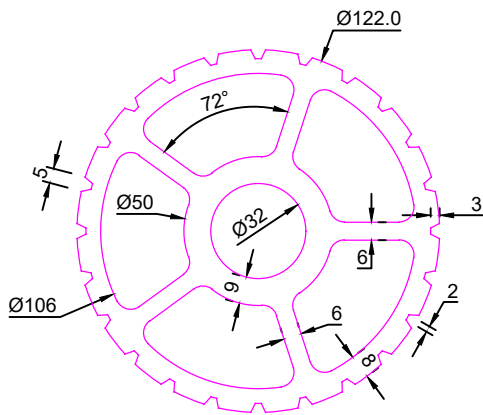

SEC No. 7180

Weight :- 25.355kg/12'

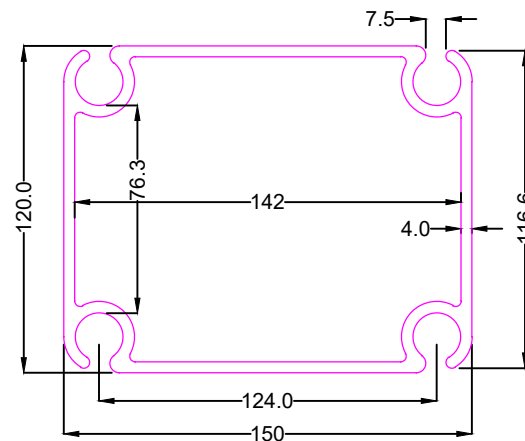

SEC No. 7181

Weight :- 23.455kg/12'

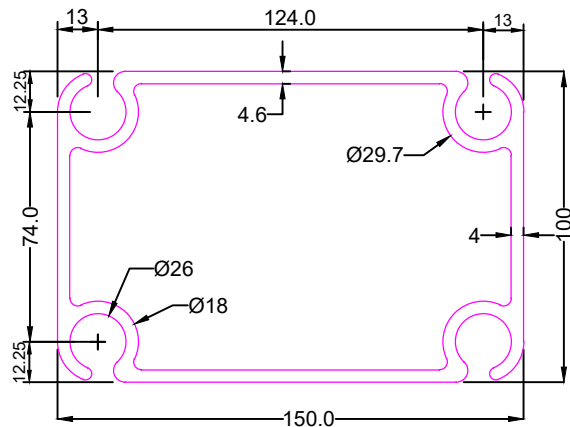

SEC No. 7183

Weight :- 1.610kg/12'

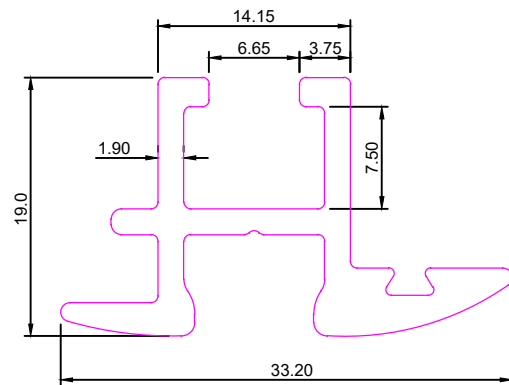



INDUSTRIAL

SEC No. 7184

Weight :- 11.00kg/12'

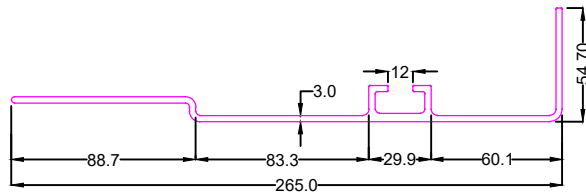

SEC No. 7185

Weight :- 8.150kg/12'

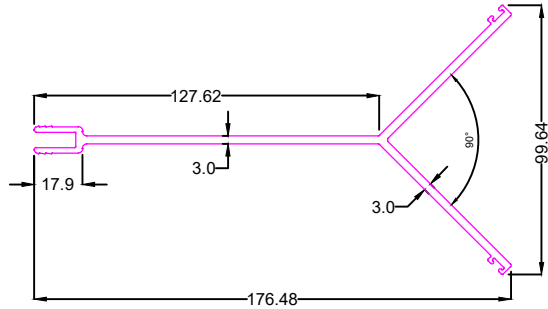

SEC No. 7186

Weight :- 12.000kg/12'

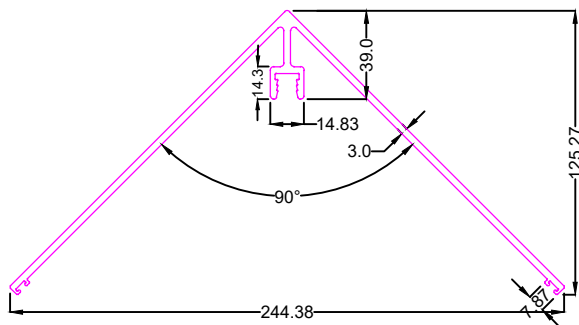

SEC No. 7190

Weight :- 22.550kg/12'

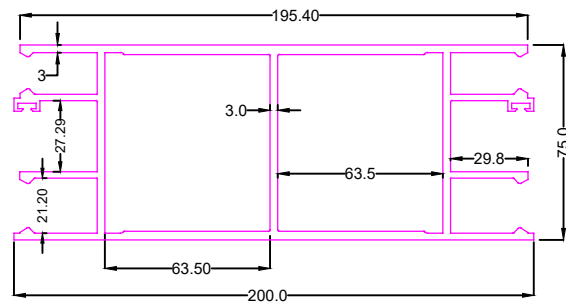

SEC No. 7191

Weight :- 4.300kg/12'

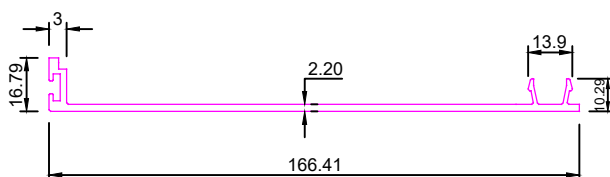

SEC No. 7192

Weight :- 1.135kg/12'

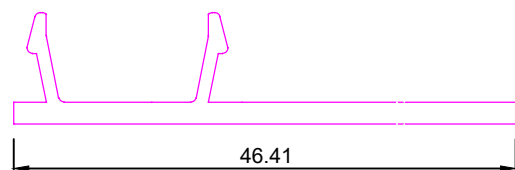



INDUSTRIAL

SEC No. 7193

Weight :-0.825kg/12'

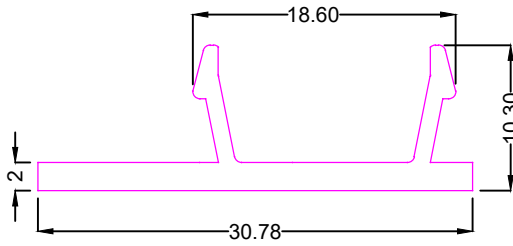

SEC No. 7198

Weight :-26.115kg/12'

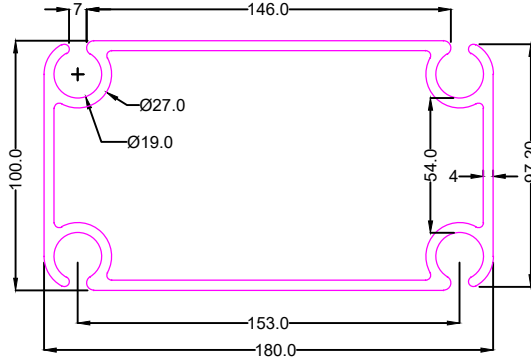

SEC No. 7199

Weight :-28.440kg/12'

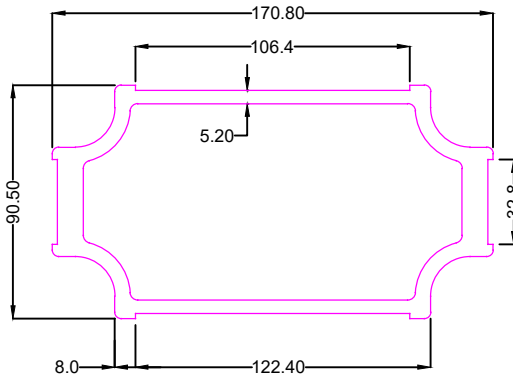

SEC No. 7200

Weight :-5.000kg/12'

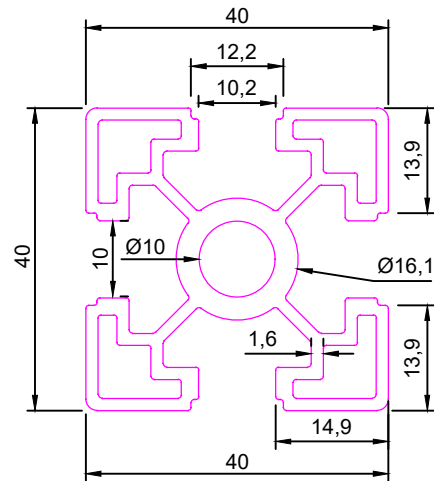

SEC No. 7203

Weight :-0.262kg/12'

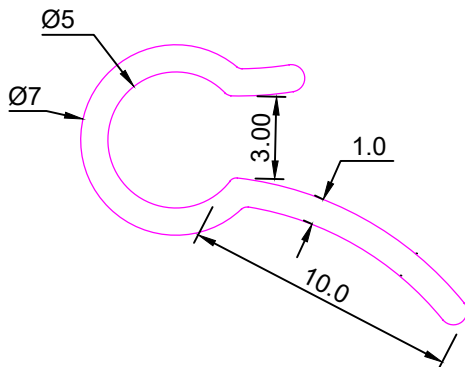

SEC No. 7205

Weight :-2.160kg/12'

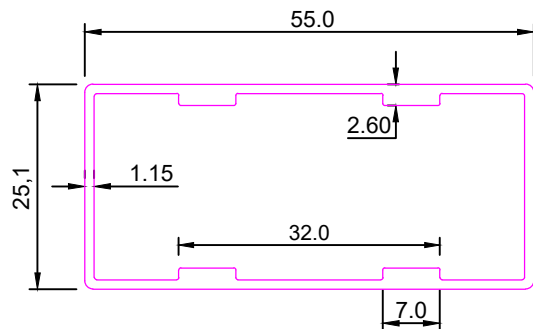



INDUSTRIAL

SEC No. 7209

Weight :-5.995kg/12'

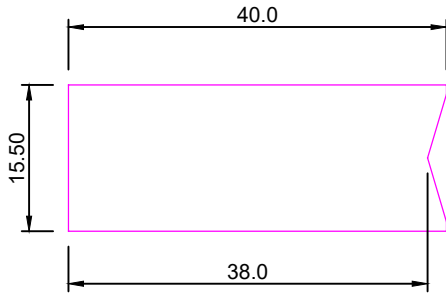

SEC No. 7210

Weight :-24.830kg/12'

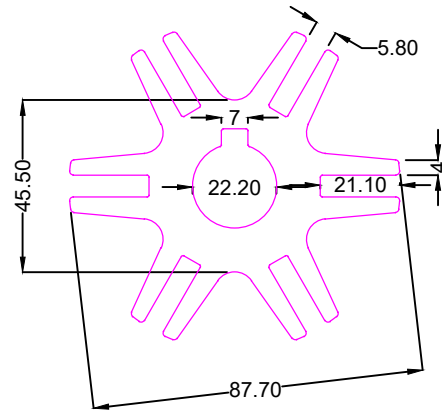

SEC No. 7211

Weight :-9.315kg/12'

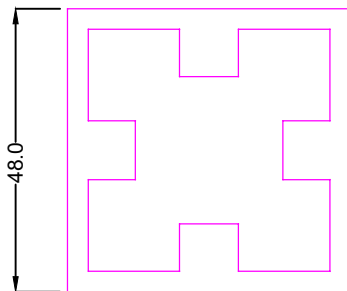

SEC No. 7212

Weight :-10.700kg/12'

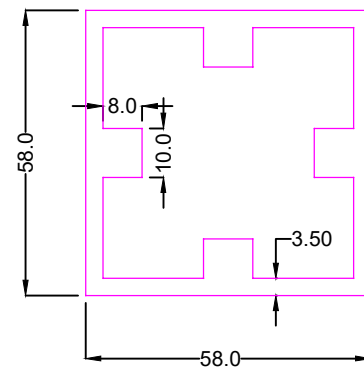

SEC No. 7220

Weight :-6.990kg/12'

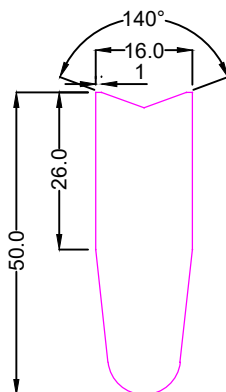

SEC No. 7226

Weight :-1.385kg/12'

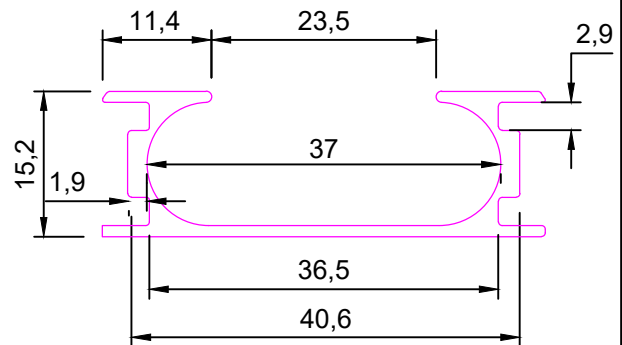



INDUSTRIAL

SEC No. 7243

Weight :-5.625kg/12'

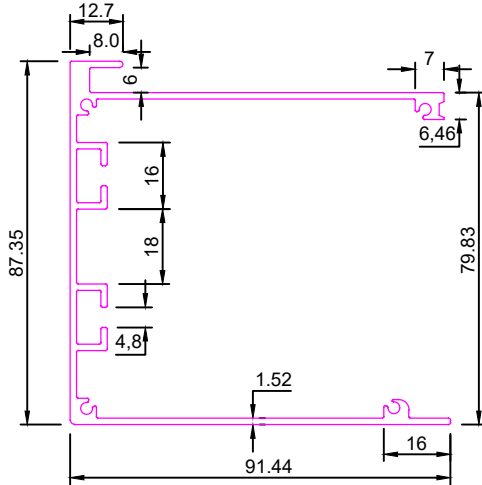

SEC No. 7244

Weight :-1.585kg/12'

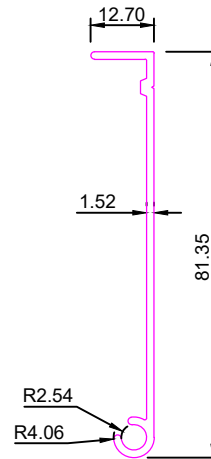

SEC No. 7256

Weight :-2.815kg/12'

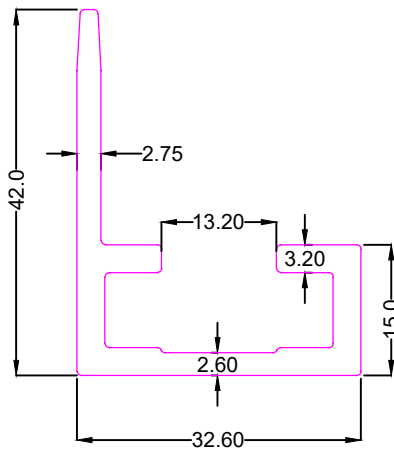

SEC No. 7274

Weight :-0.670kg/12'

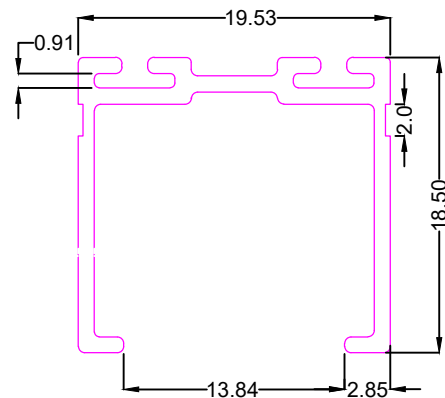

SEC No. 7275

Weight :-0.830kg/12'

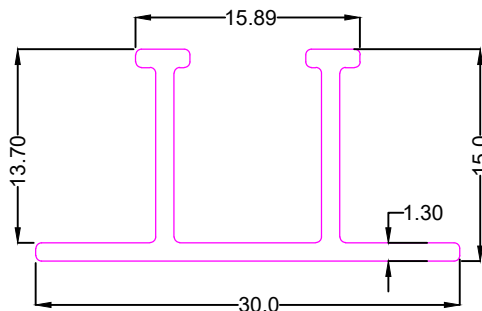

SEC No. 7314

Weight :-5.550kg/12'

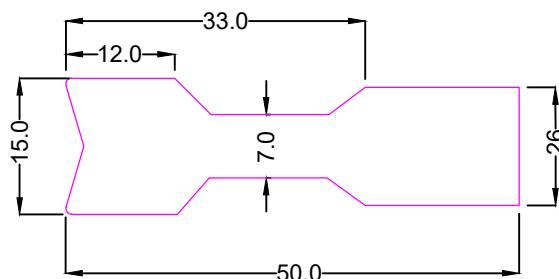



INDUSTRIAL

SEC No. 7327

Weight :-5.300kg/12'

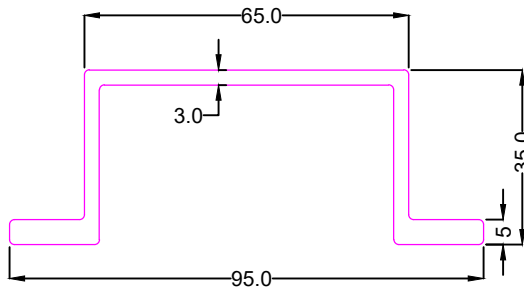

SEC No. 7329

Weight :-9.245kg/12'

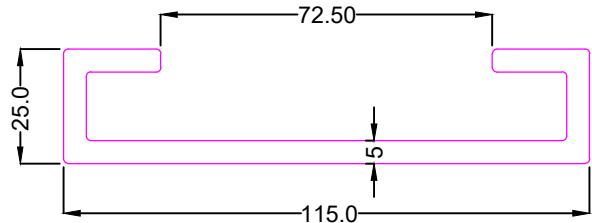

SEC No. 7340

Weight :-2.680kg/12'

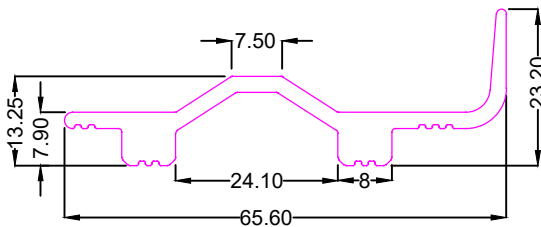

SEC No. 7346

Weight :-5.725kg/12'

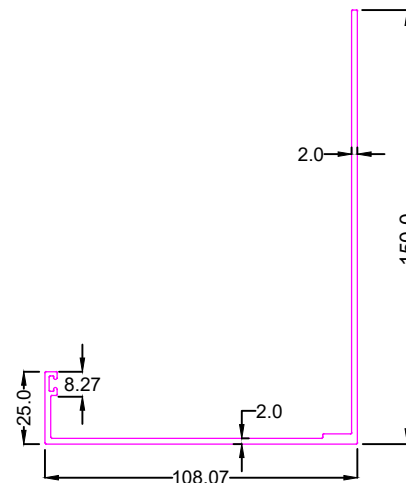

SEC No. 7368

Weight :-6.875kg/12'

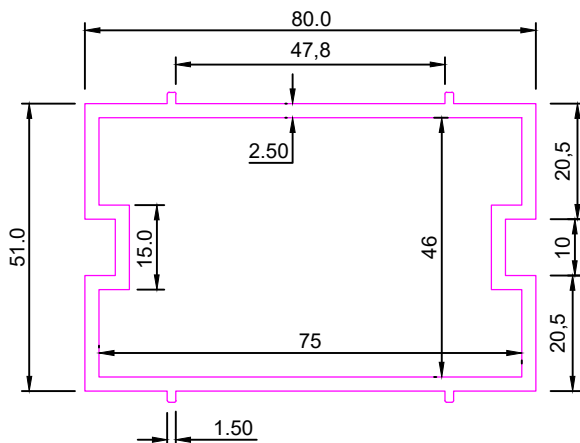

SEC No. 7369

Weight :-8.650kg/12'

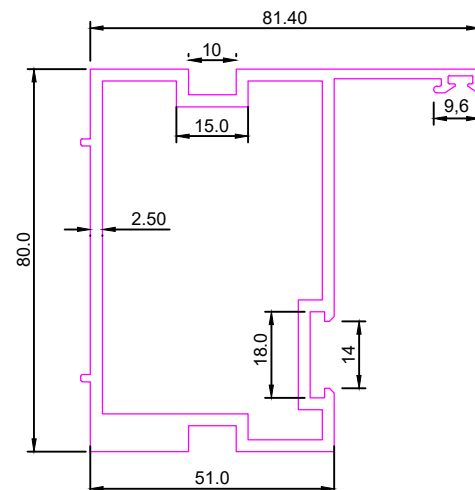



INDUSTRIAL

SEC No.7370

Weight :-8.770kg/12'

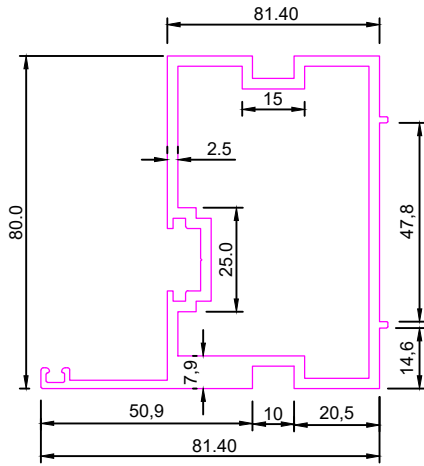

SEC No. 7371

Weight :-7.275kg/12'

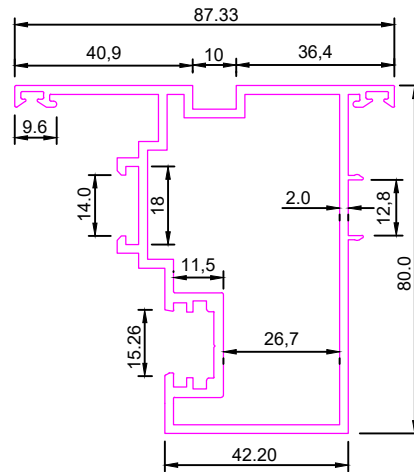

SEC No. 7374

Weight :-1.700kg/12'

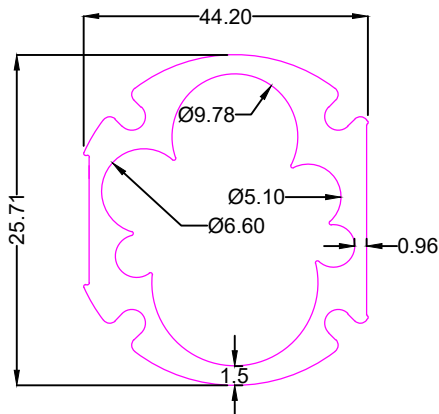

SEC No. 7375

Weight :-1.260kg/12'

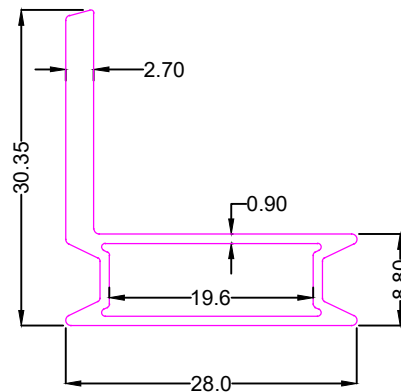

SEC No. 7389

Weight :-32.615kg/12'

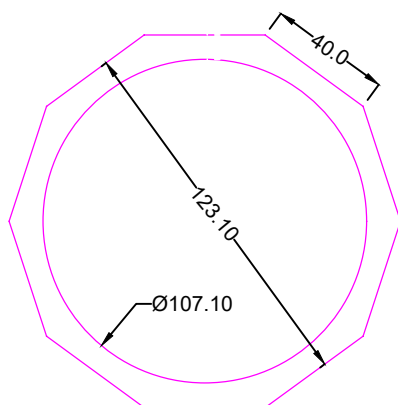

SEC No. 7390

Weight:- 5.900kg/12'

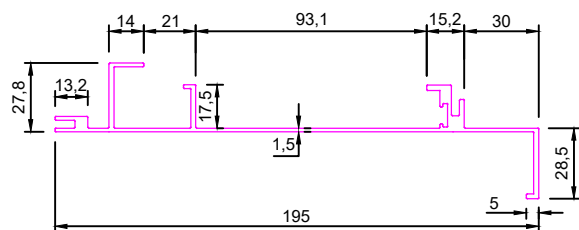



INDUSTRIAL

SEC No. 7404

Weight:-12.660kg/12'

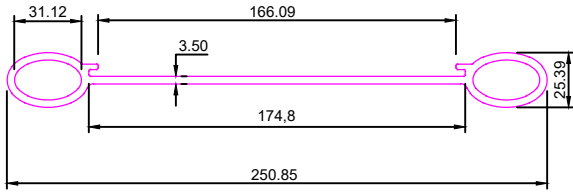

SEC No. 7405

Weight:-2.060kg/12'

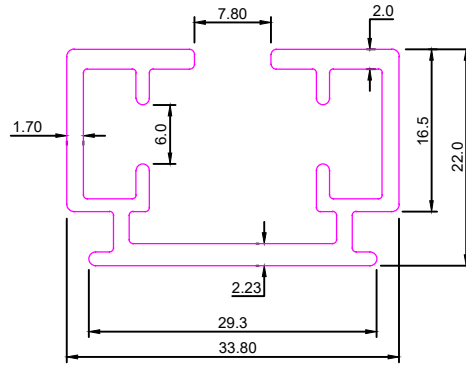

SEC No. 7416

Weight:-26.075kg/12'

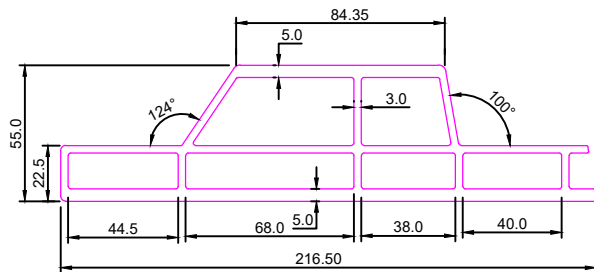

SEC No. 7417

Weight:-4.025Kg/12'

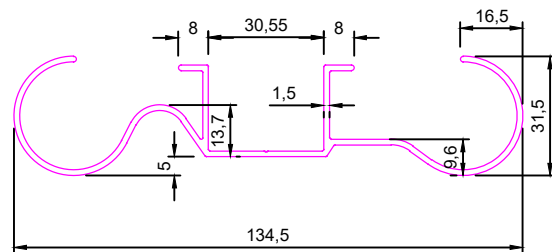

SEC No. 7420

Weight:-3.300Kg/12'

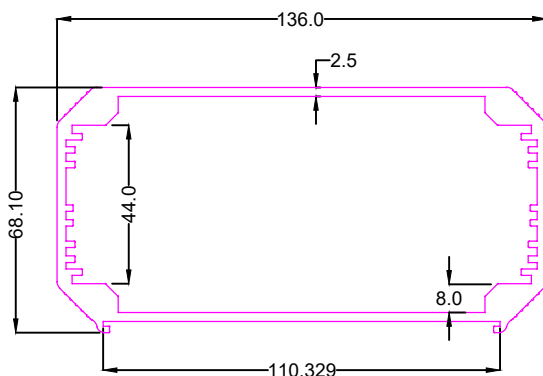

SEC No. 7437

Weight:-15.695Kg/12'

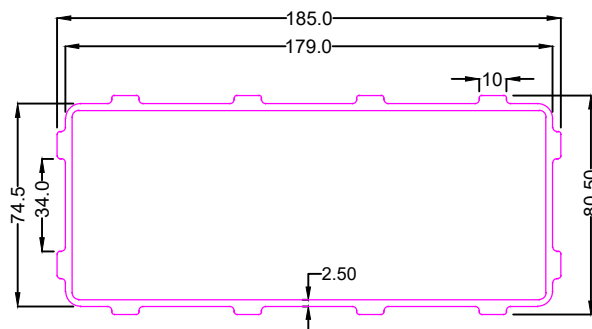



INDUSTRIAL

SEC No. 7450

Weight :- 1.200kg/12'

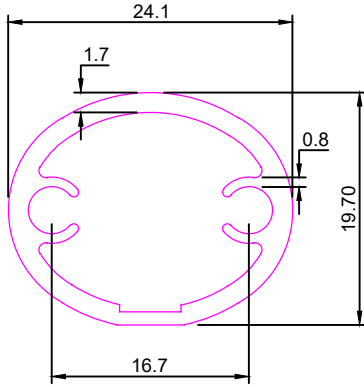

SEC No. 7459

Weight:-6.890kg/12'

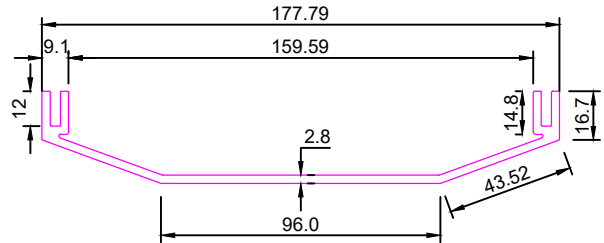

SEC No. 7465

Weight:-2.980kg/12'

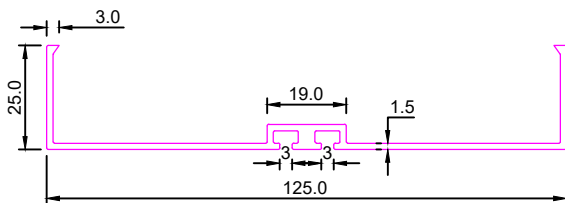

SEC No. 7466

Weight:-4.470kg/12'

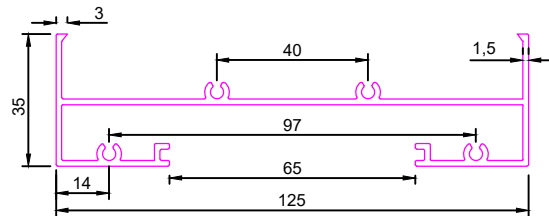

SEC No. 7483

Weight:-4.095kg/12'

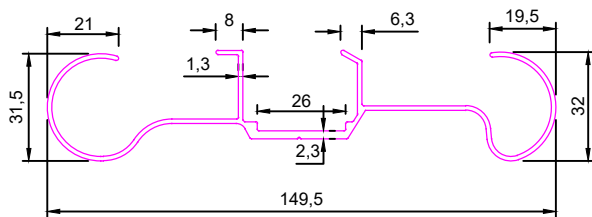

SEC No. 7490

Weight:-10.470kg/12'

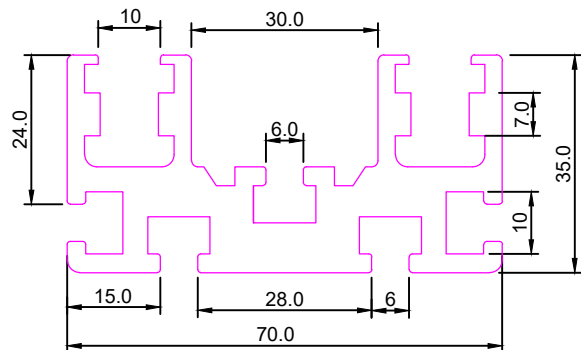



INDUSTRIAL

SEC No. 7491

Weight:-3.085kg/12'

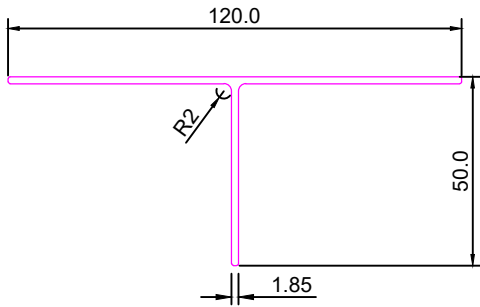

SEC No. 7492

Weight:-38.575kg/12'

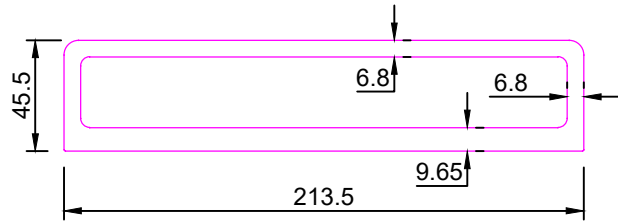

SEC No. 7493

Weight:-9.700kg/12'

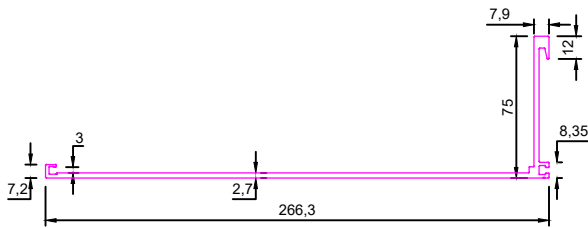

SEC. NO:-7501 Old

Weight :- 0.325kg/12'

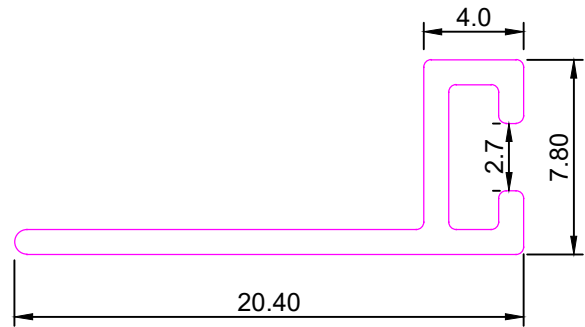

SEC. NO:-7503 Old

Weight :- 1.260kg/12'

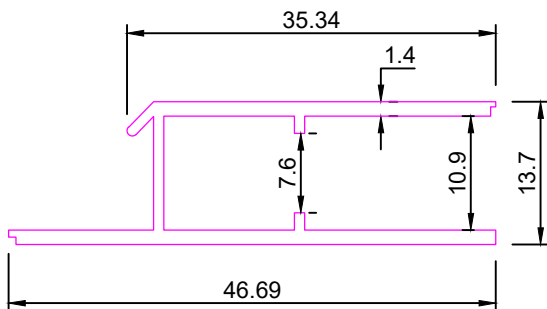

SEC. NO:-7505

Weight :- 0.750kg/12'

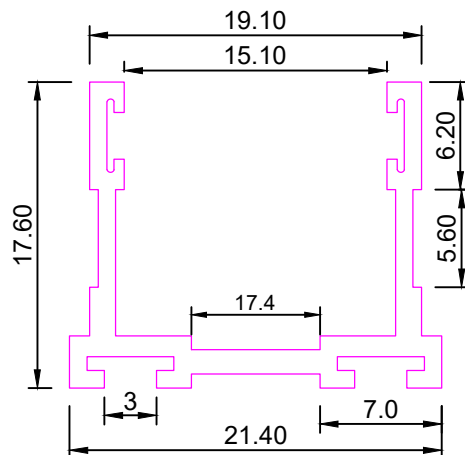



INDUSTRIAL

SEC. NO:-7507

Weight :-0.525kg/12'

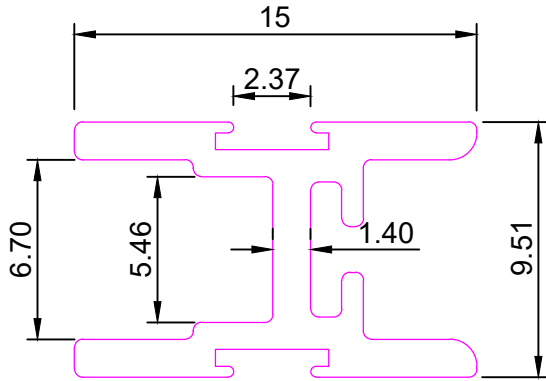

SEC. NO:-7509 OLD

Weight :- 1.160kg/12'

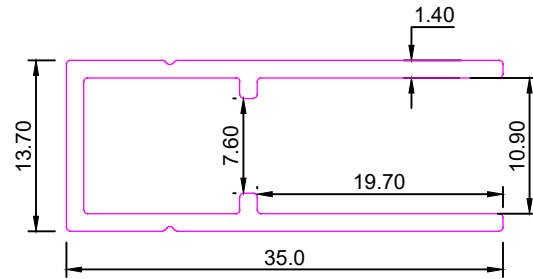

SEC. NO:-7511 Old

Weight :- 0.880kg/12'

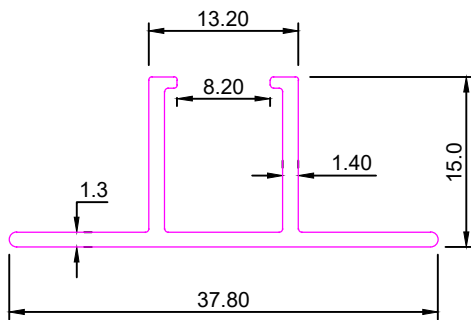

SEC. NO:-7513 Old

Weight :- 0.900kg/12'

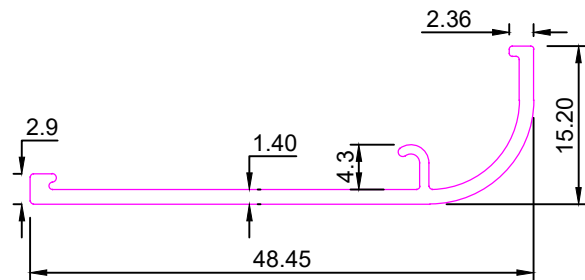

SEC. NO:-7515 Old

Weight :- 0.555kg/12'

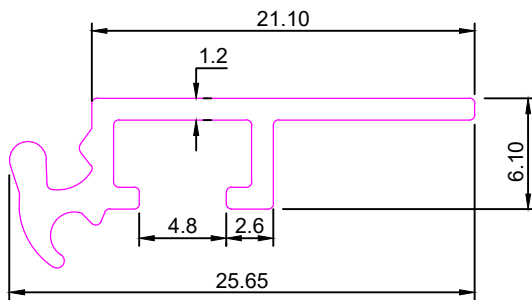

SEC. NO:-7517 Old

Weight :- 0.625kg/12'

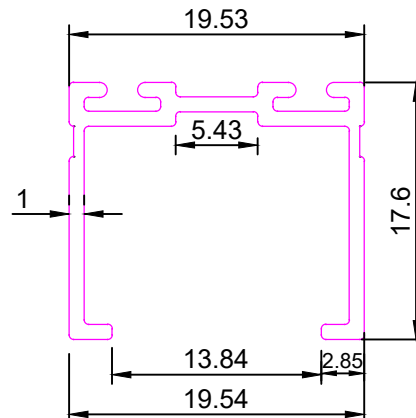



INDUSTRIAL

SEC. NO:-7519 Old

Weight :- 0.800kg/12'

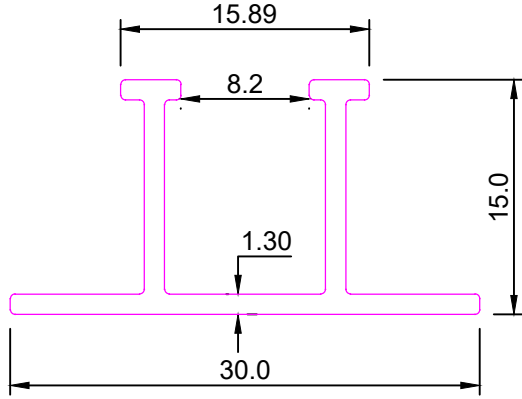

SEC No. 7510

Weight:-4.400kg/12'

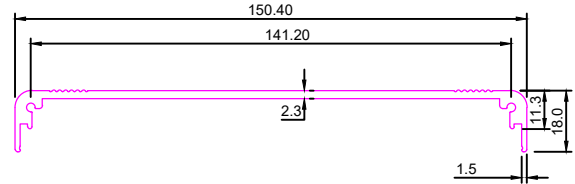

SEC No. 7511

Weight:-6.850kg/12'

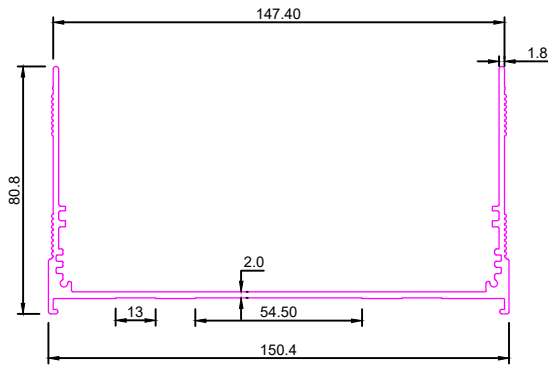

SEC No. 7512

Weight:-1.800kg/12'

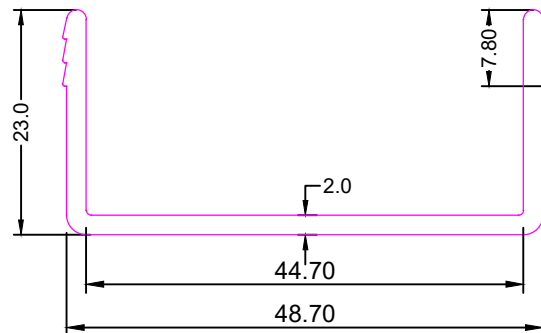

SEC No. 7513

Weight:-5.200kg/12'

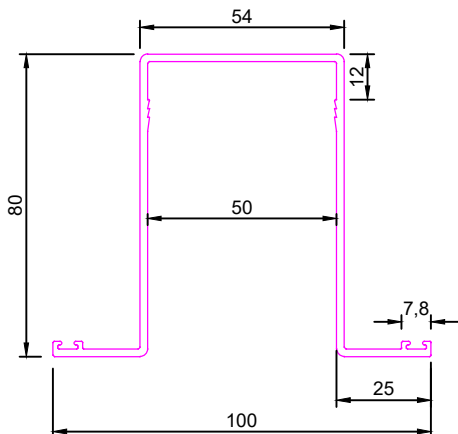

SEC No. 7517

Weight:-4.135kg/12'

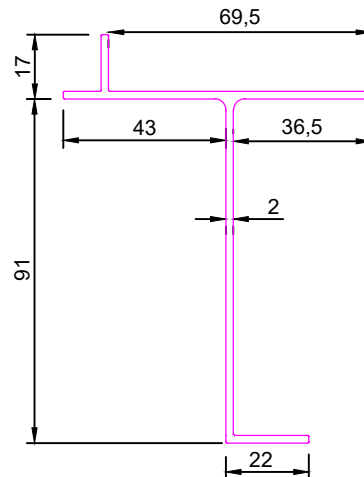



INDUSTRIAL

SEC No. 7518

Weight:-2.630kg/12'

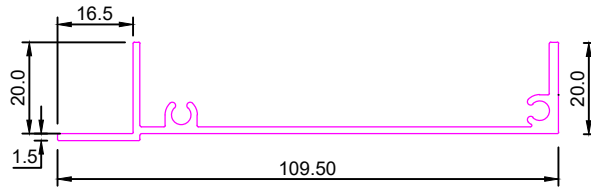

SEC No. 7519

Weight:-3.720kg/12'

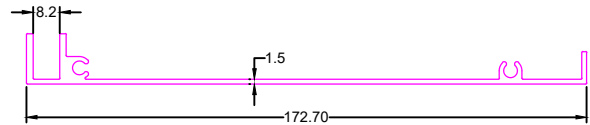

SEC No. 7520

Weight:-3.240kg/12'

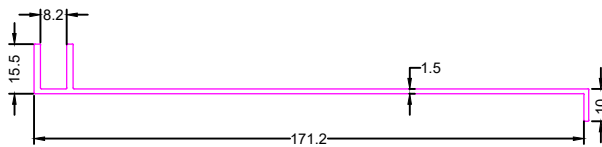

SEC. NO:-7521 Old

Weight :- 1.365kg/12'

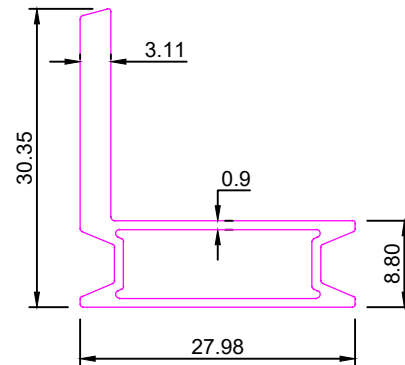

SEC. NO:-7523 Old

Weight :- 1.245kg/12'

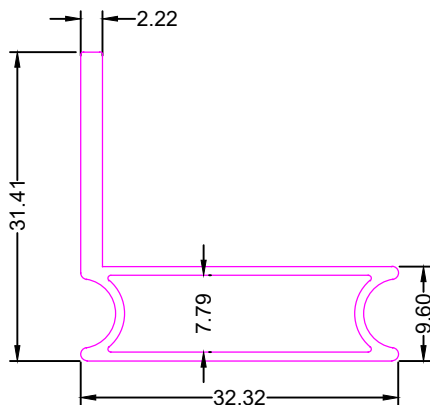

SEC. NO:-7525 Old

Weight :- 0.670kg/12'

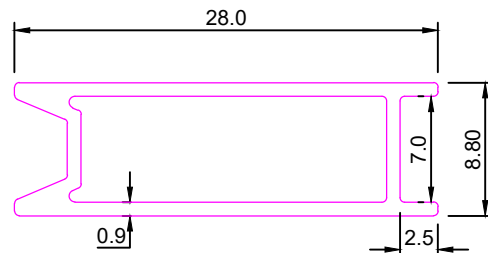



INDUSTRIAL

**SEC. NO:-3281
75..**

Weight :- 0.375kg/12'

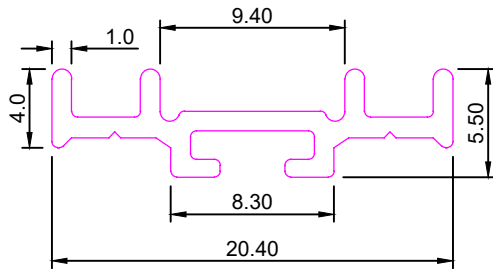

SEC. NO:-7528

Weight :- 1.957kg/12'

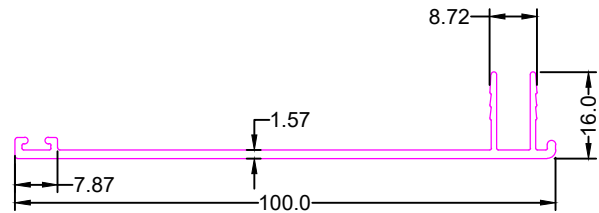

SEC. NO:-7537

Weight :- 0.790kg/12'

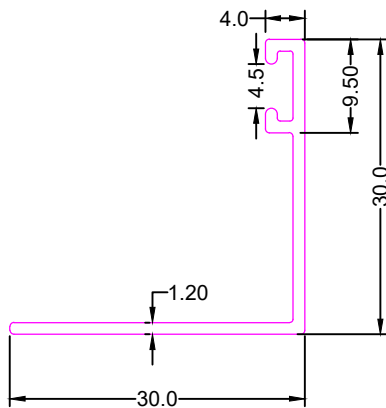

SEC. NO:-7539

Weight :- 2.335kg/12'

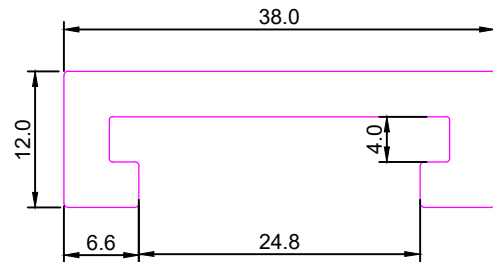

SEC. NO:-7540

Weight :- 4.628kg/12'

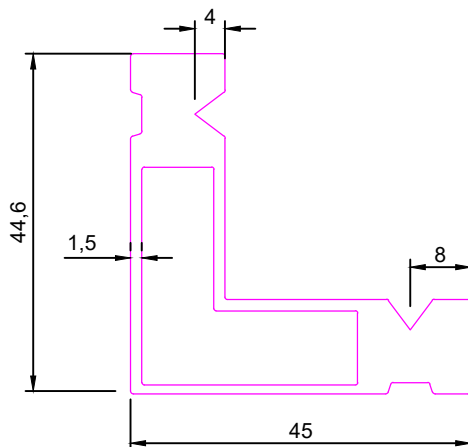

SEC. NO:-7546

Weight :- 2.500kg/12'

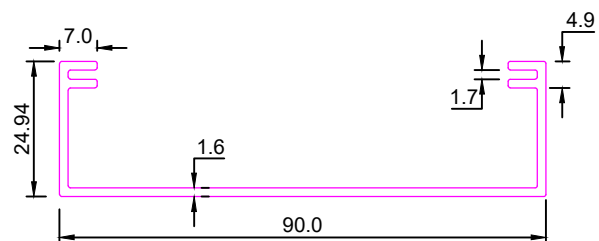



INDUSTRIAL

SEC. NO:-7548

Weight :- 3.350kg/12'

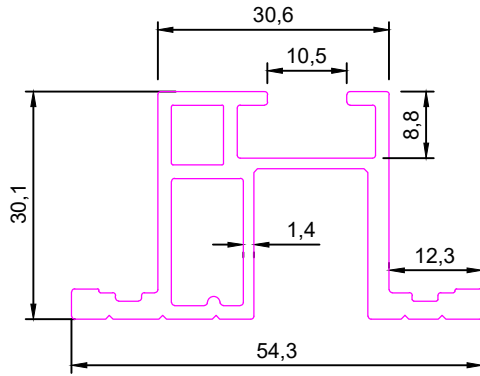

SEC. NO:-7551

Weight :- 14.220kg/12'

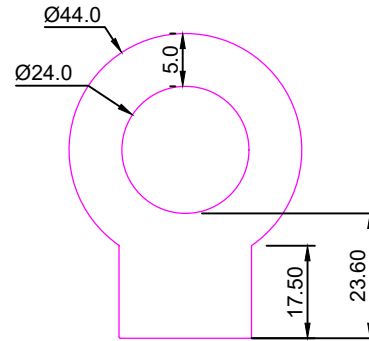

SEC. NO:-7552

Weight :- 21.900kg/12'

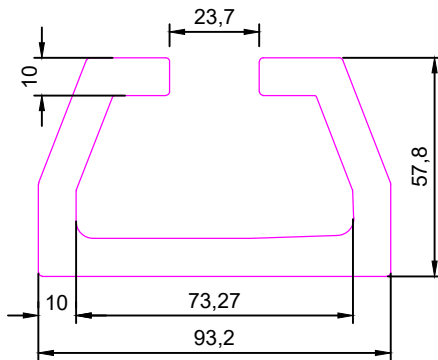

SEC. NO:-7554

Weight :- 3.558kg/12'

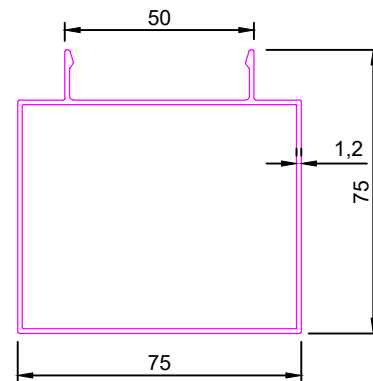

SEC. NO:-7557

Weight :- 0.316kg/12'

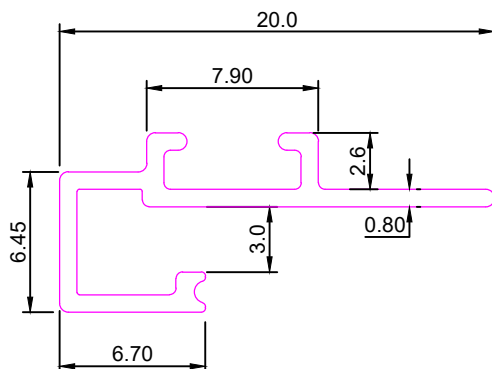

SEC. NO:-7558

Weight :- 0.290kg/12'

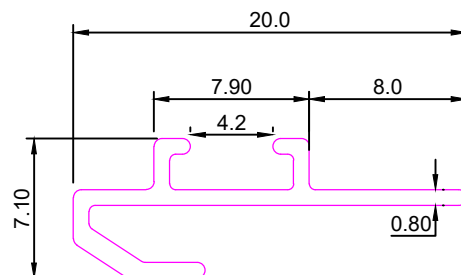



INDUSTRIAL

SEC. NO:-7563

Weight :-2.490kg/12'

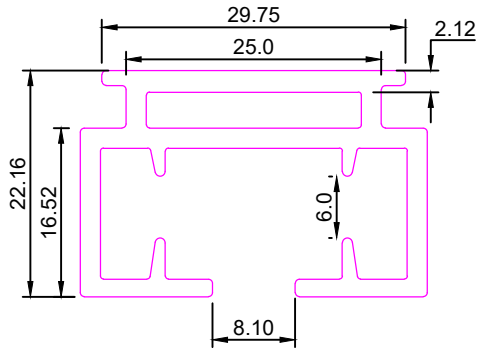

SEC. NO:-7564

Weight :-1.147kg/12'

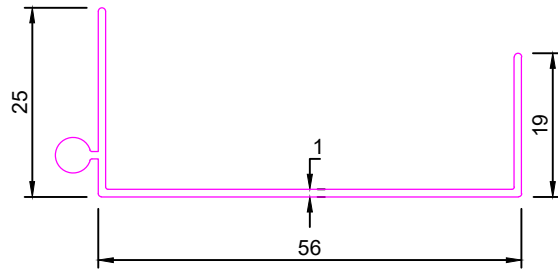

SEC. NO:-7565

Weight :-1.135kg/12'

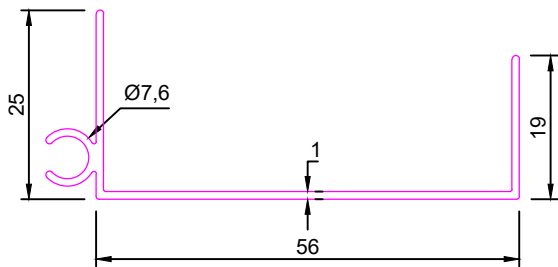

SEC. NO:-7566

Weight :-0.725kg/12'

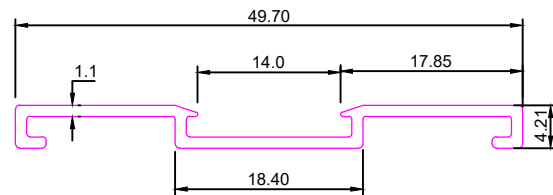

SEC. NO:-7567

Weight :-5.245kg/12'

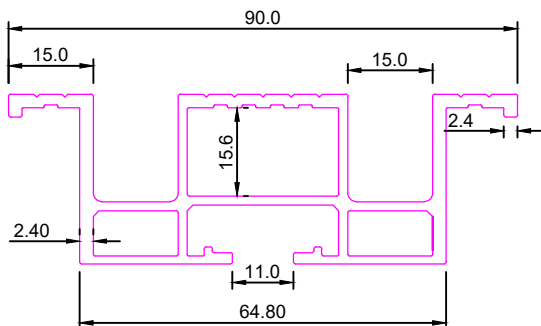

SEC. NO:-7570

Weight :-3.165kg/12'

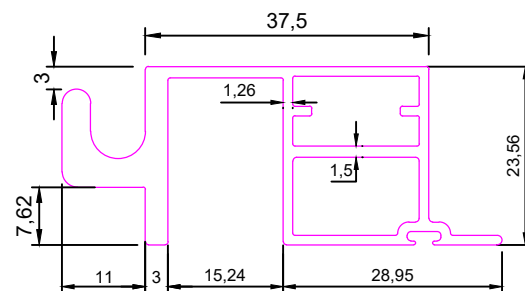



INDUSTRIAL

SEC. NO:-7571

Weight :-2.910kg/12'

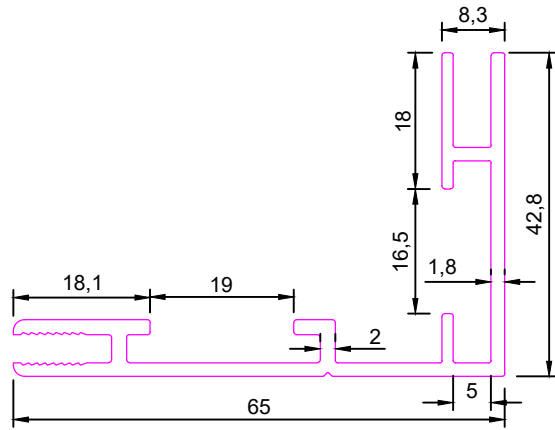

SEC. NO:-7572

Weight :-2.180kg/12'

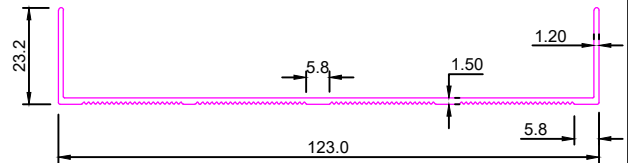

SEC. NO:-7573

Weight :-0.640kg/12'

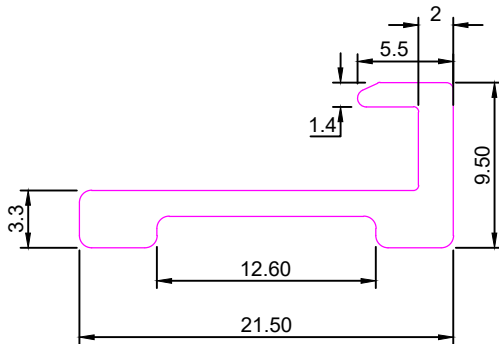

SEC. NO:-7576

Weight :-0.610kg/12'

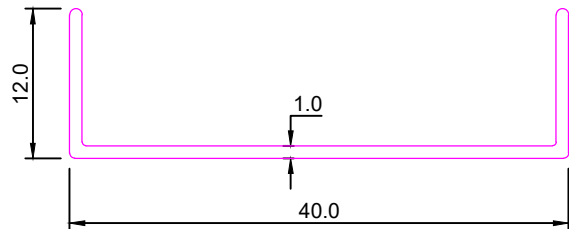

SEC. NO:-7577

Weight :- 1.330kg/12'

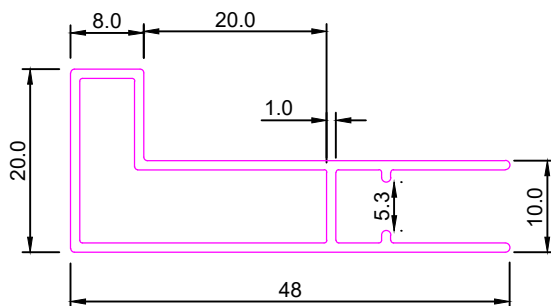

SEC. NO:-7579

Weight :- 2.480kg/12'

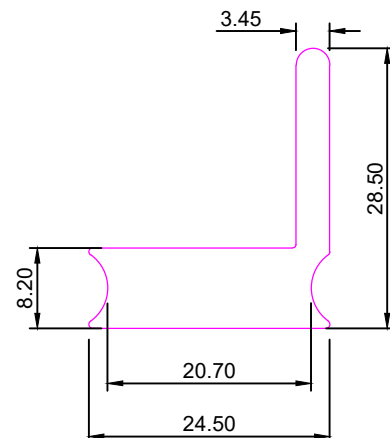



INDUSTRIAL

SEC. NO:-7581

Weight :- 3.794kg/12'

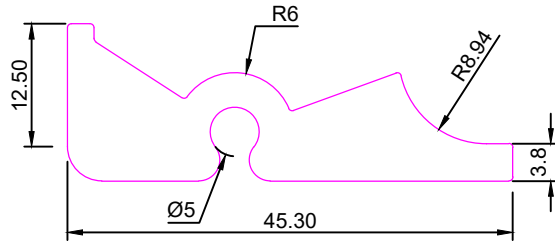

SEC. NO:-7582

Weight :-5.232kg/12'

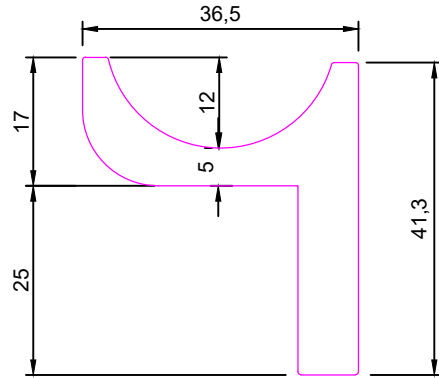

SEC. NO:-7585

Weight :- 0.495kg/12'

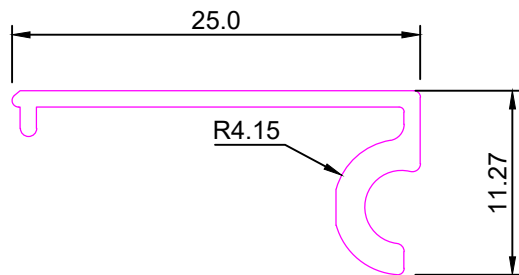

SEC. NO:-7586

Weight :- 0.885kg/12'

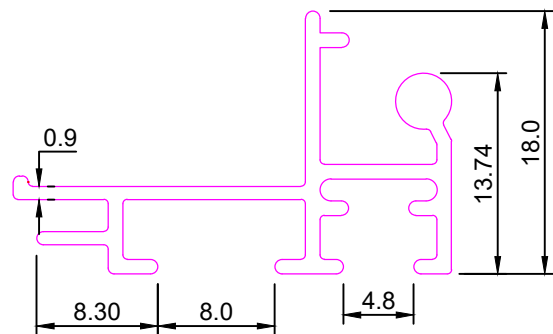

SEC. NO:-7588

Weight :- 2.620kg/12'

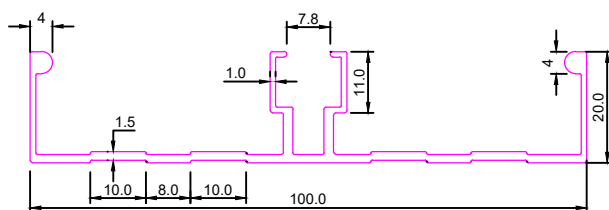

SEC. NO:-7590

Weight :- 1.077kg/12'

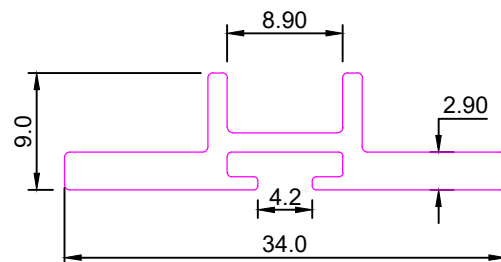



INDUSTRIAL

SEC. NO:-7593

Weight :- 1.400kg/12'

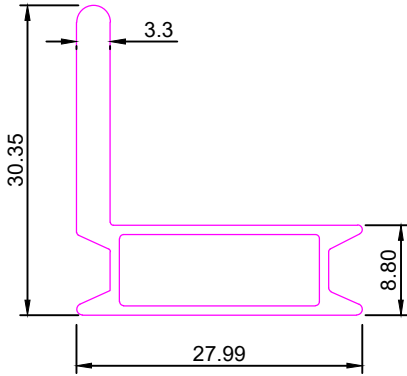

SEC No. 7601

Weight :- 2.500kg/12'

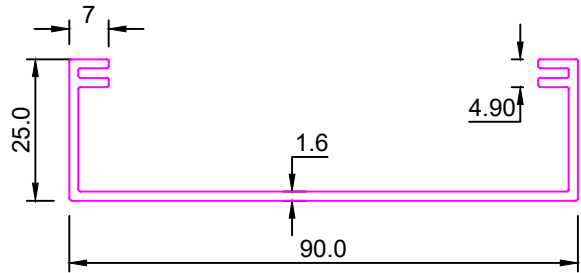

SEC. NO:-7622

Weight :- 5.545kg/12'

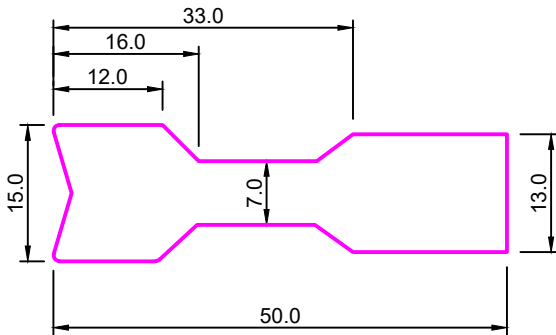

SEC. NO:-7623

Weight :-2.210kg/12'

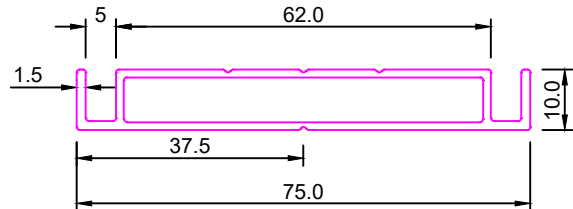

SEC No. 7632

Weight:-15.385Kg/12'

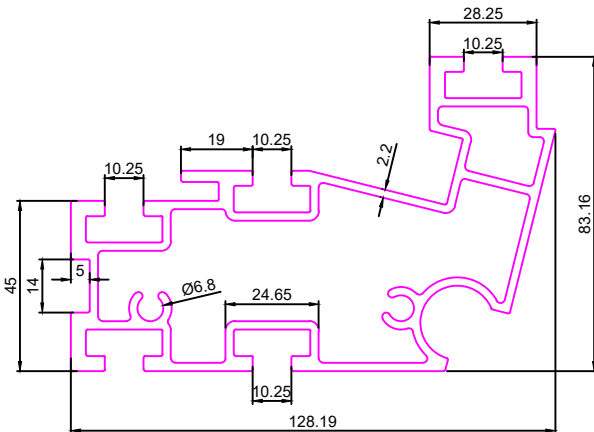

SEC No. 7633

Weight:-18.730Kg/12'

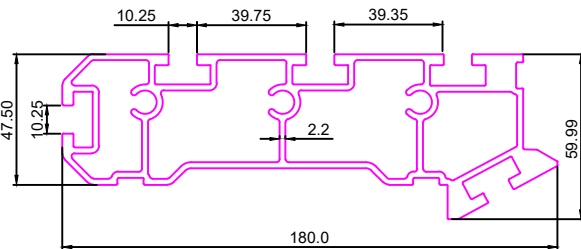



INDUSTRIAL

SEC No. 7635

Weight:-4.810Kg/12'

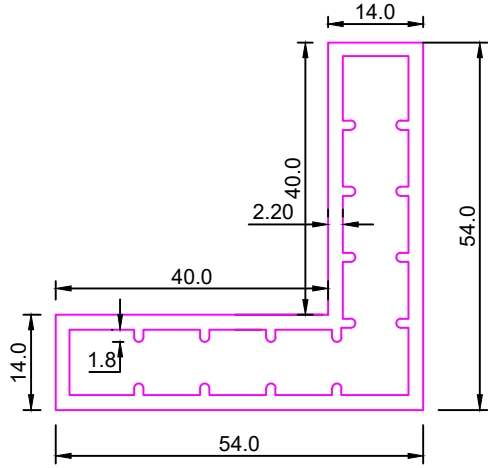

SEC No. 7636

Weight:-4.500Kg/12'

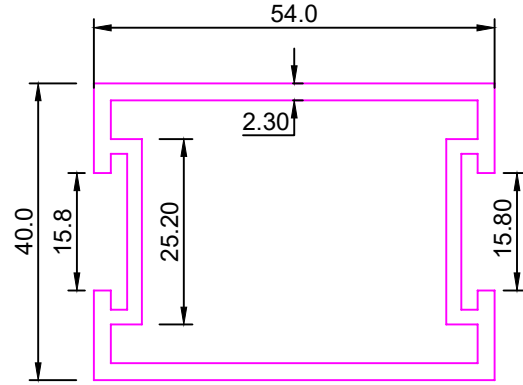

SEC No. 7637

Weight:-4.550Kg/12'

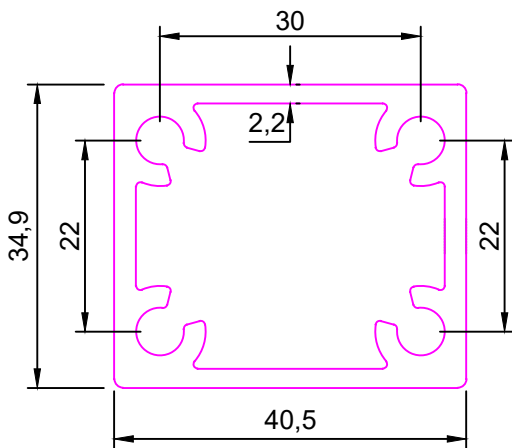

SEC No. 7638

Weight:-65.950Kg/12'

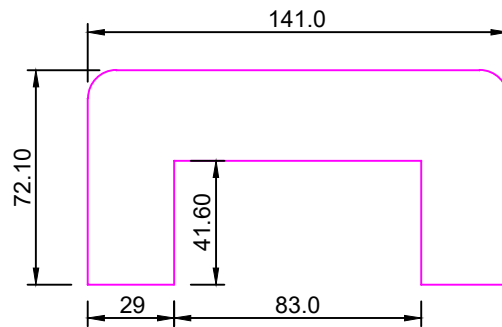

SEC No. 7639

Weight:-0.830Kg/12'

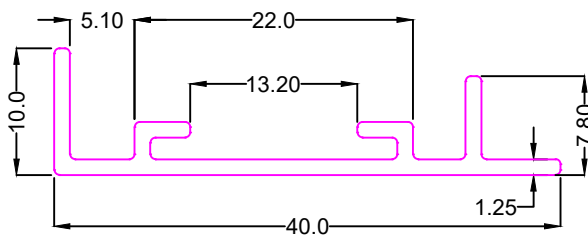

SEC No. 7665

Weight:34.750Kg/12'

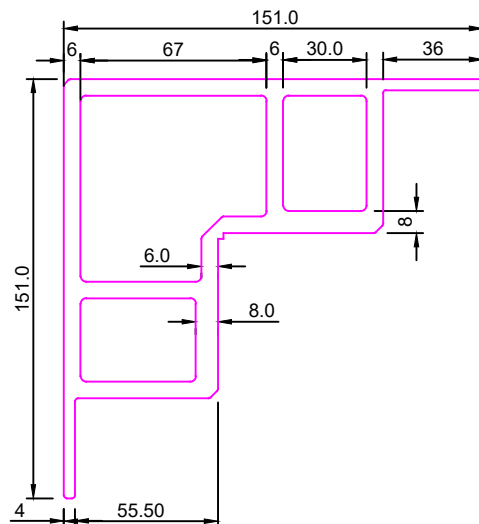



INDUSTRIAL

SEC. NO:- 7666

Weight :-7.950kg/12'

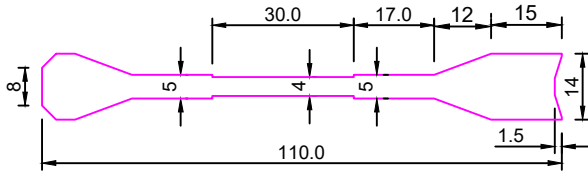

SEC. NO:- 7672

Weight :-3.700kg/12'

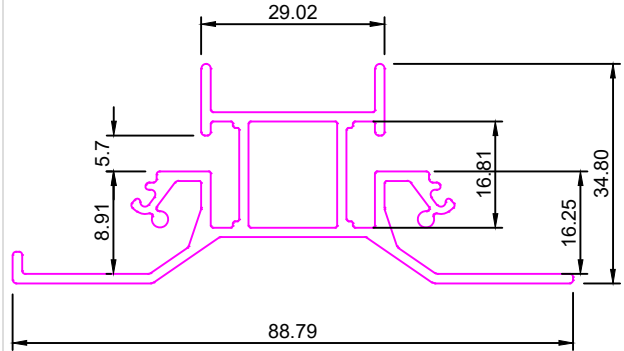

SEC. NO:- 7673

Weight :-2.400kg/12'

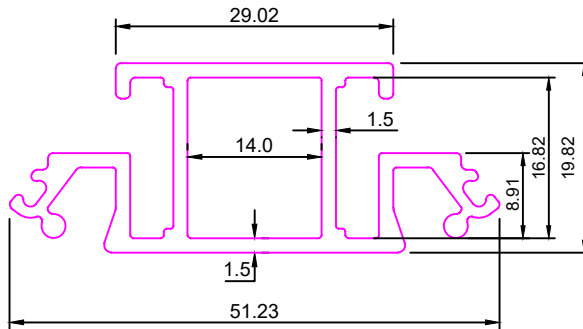

SEC. NO:- 7674

Weight :-2.200kg/12'

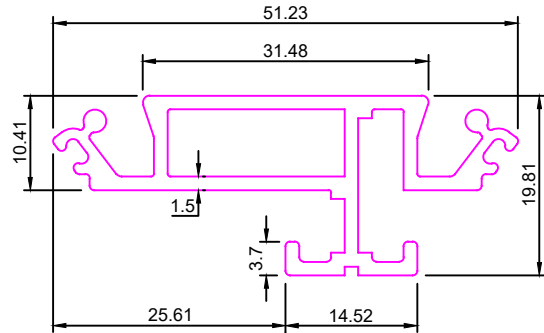

SEC. NO:- 7675

Weight :-0.700kg/12'

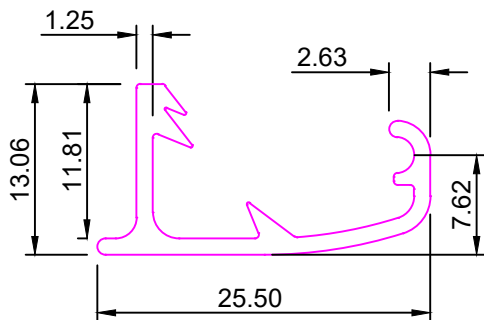

SEC. NO:- 7681

Weight :-6.270kg/12'

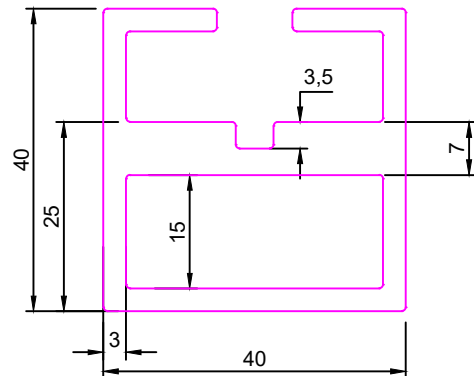



INDUSTRIAL

SEC. NO:- 7682

Weight :-5.950kg/12'

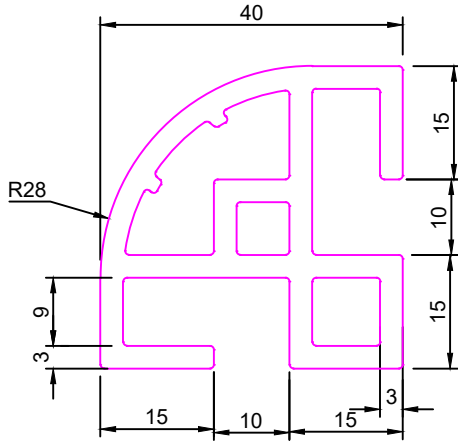

SEC No. 7722

Weight:-12.000Kg/12'

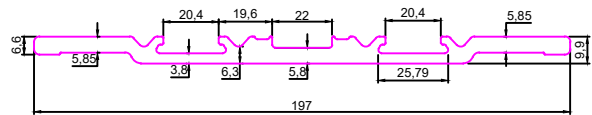

SEC No. 7723

Weight:-4.250Kg/12'

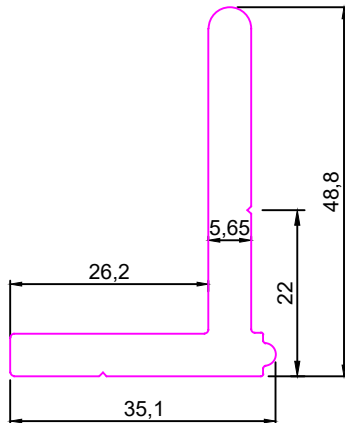

SEC No. 7724

Weight:-4.200Kg/12'

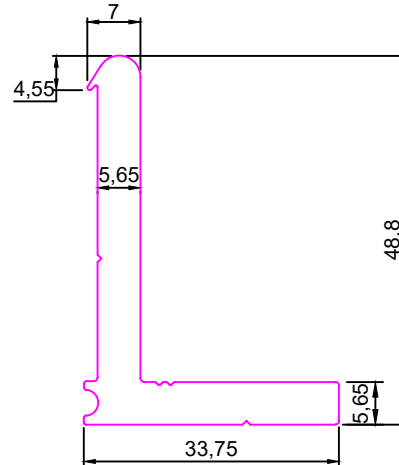

SEC No. 7735

Weight:-31.100Kg/12'

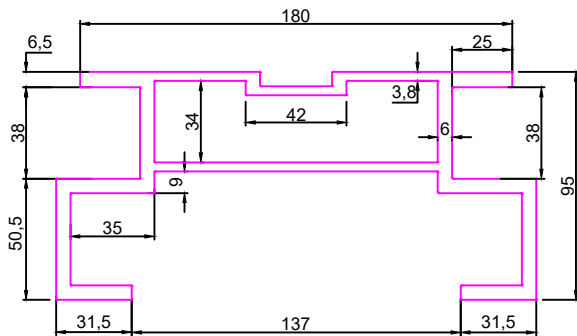

SEC No. 7736

Weight:-32.150Kg/12'

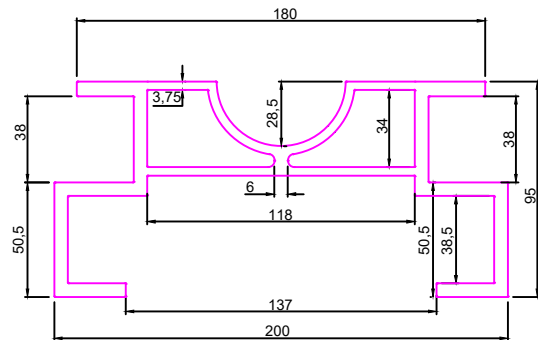



INDUSTRIAL

SEC No. 7743

Weight:-5.950Kg/12'

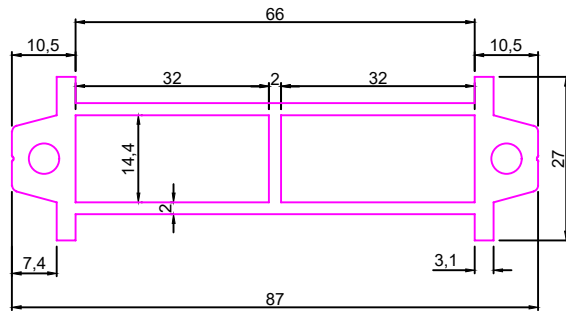

SEC No. 7746

Weight:-4.900Kg/12'

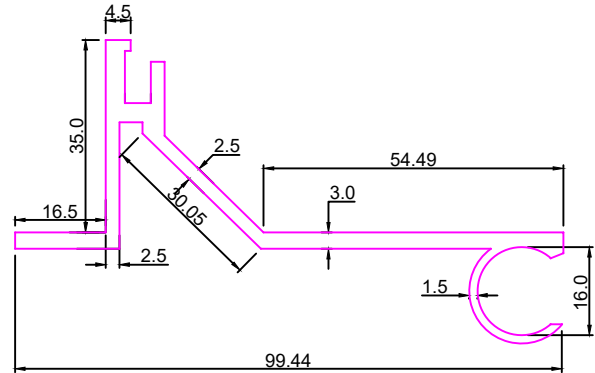

SEC No. 7747

Weight:-2.500Kg/12'

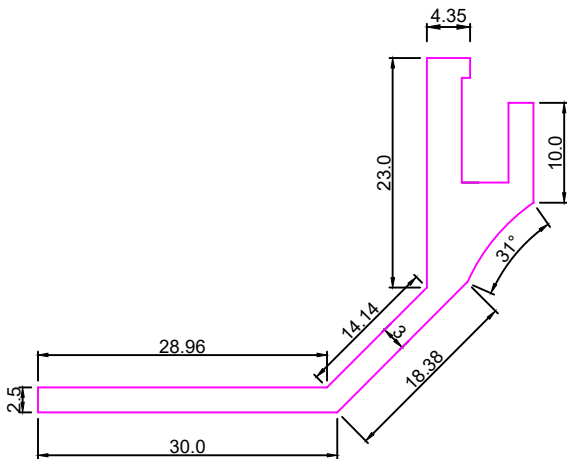

SEC No. 7753

Weight:-4.900Kg/12'

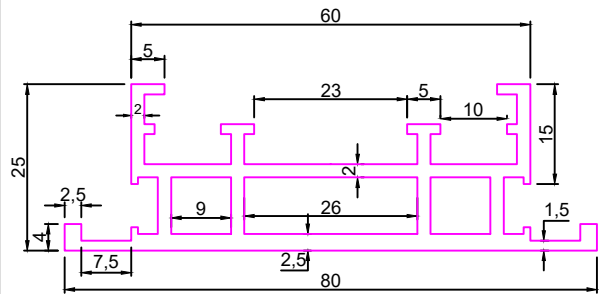

SEC No. 7754

Weight:-17.393Kg/12'

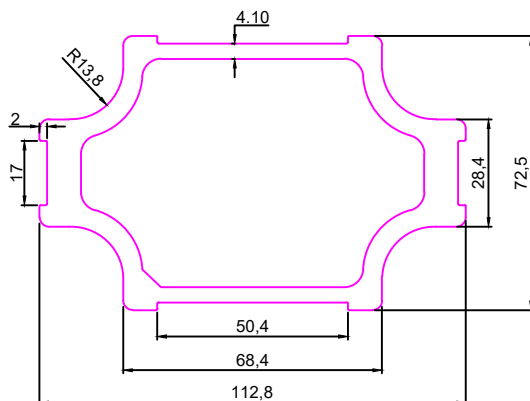

SEC No. 7756

Weight:-30.950Kg/12'

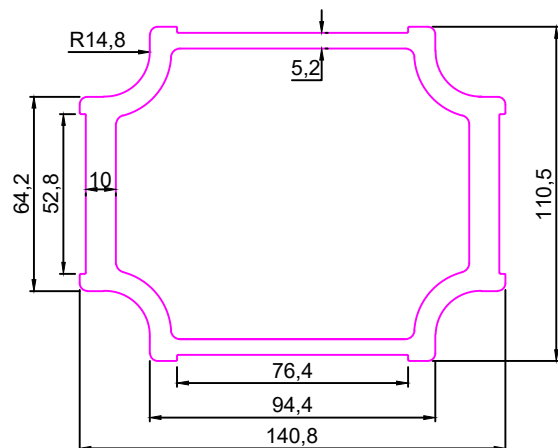



INDUSTRIAL

SEC No. 7890

Weight:-47.800Kg/12'

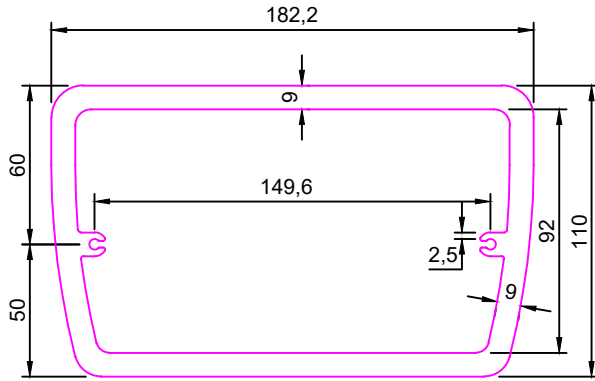

SEC No. 7899

Weight:15.155Kg/12'

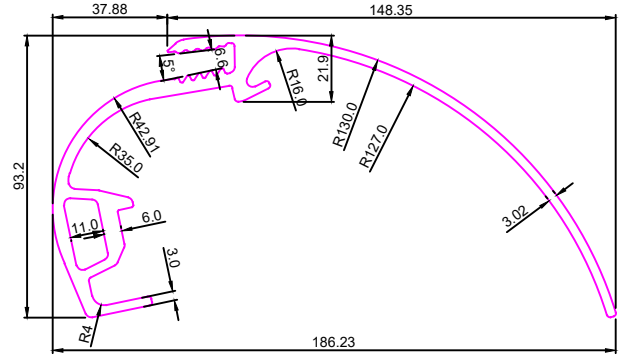

SEC No. 7919

Weight:-8.265Kg/12'

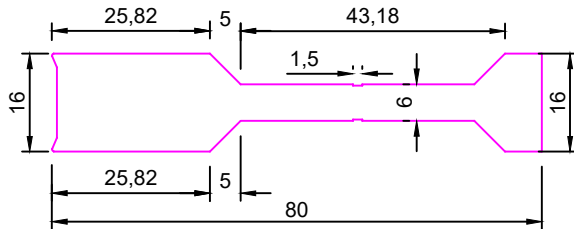

SEC No. 7944

Weight:-3.845Kg/12'

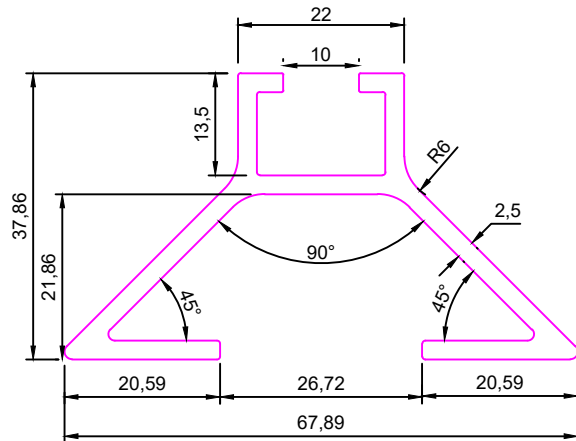

SEC No. 7947

Weight:-1.300Kg/12'

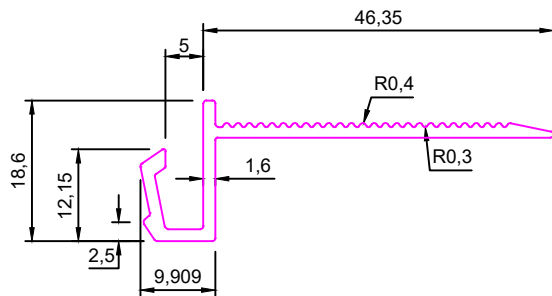

SEC No. 7951

Weight:-0.575Kg/12'

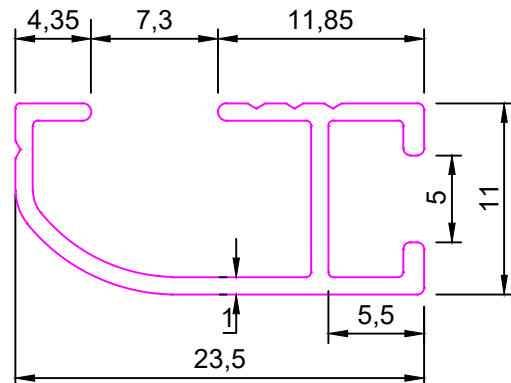



INDUSTRIAL

SEC No. 7955

Weight:-9.400Kg/12'

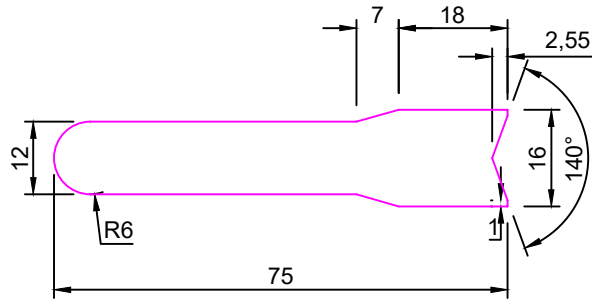

SEC No. 7959

Weight:-3.250Kg/12'

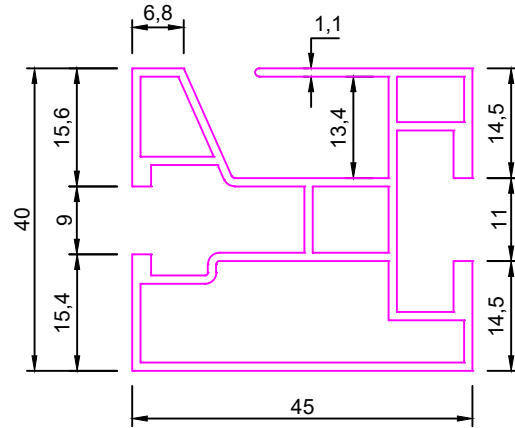

SEC No. 7963

Weight:-4.550Kg/12'

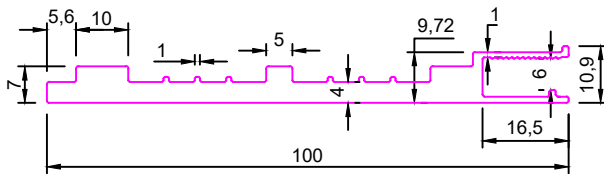

SEC No. MA7983

Weight:-5.592Kg/12'

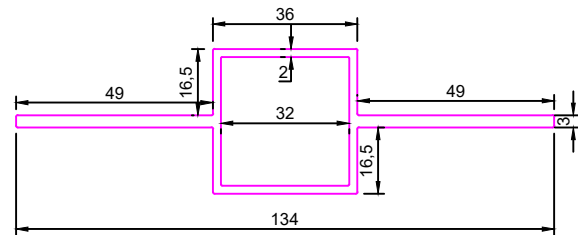

SEC No. MA7991

Weight:-44.950Kg/12'

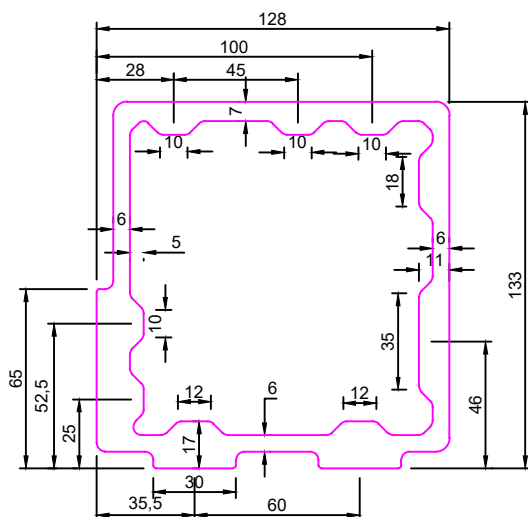

SEC No. 7958

Weight:-1.040Kg/12'

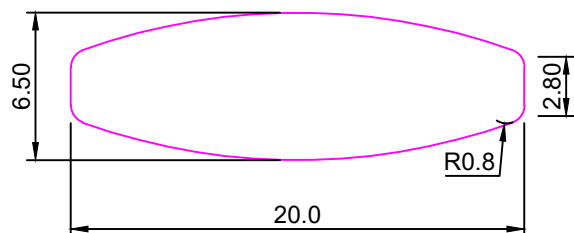



INDUSTRIAL

SEC No. 8027

Weight:-1.100Kg/12'

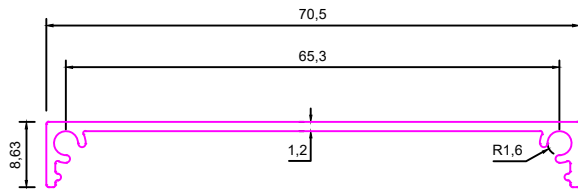

SEC No. 8028

Weight:-1.700Kg/12'

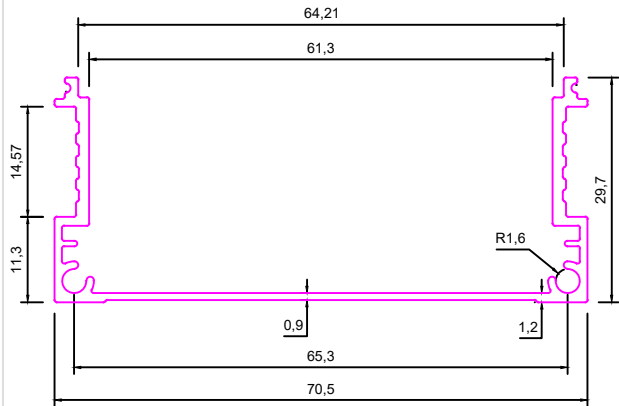

SEC No. 8029

Weight:-2.385Kg/12'

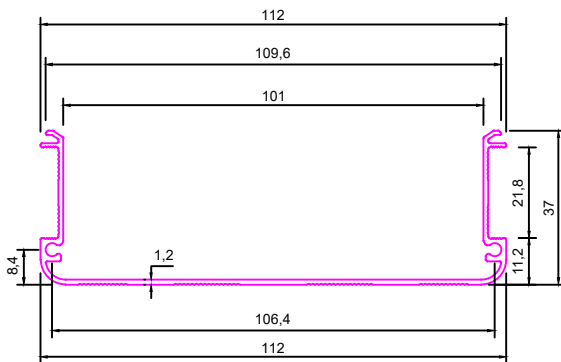

SEC No. 8030

Weight:-1.585Kg/12'

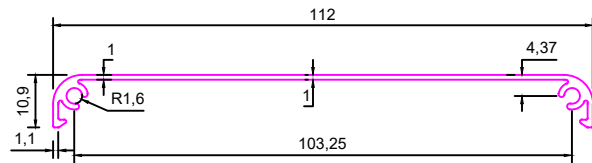

SEC No. 8044

Weight:-0.330Kg/12'

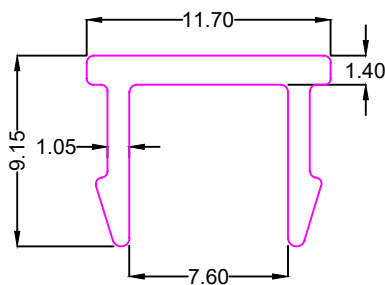

SEC No. 8045

Weight:-12.150Kg/12'

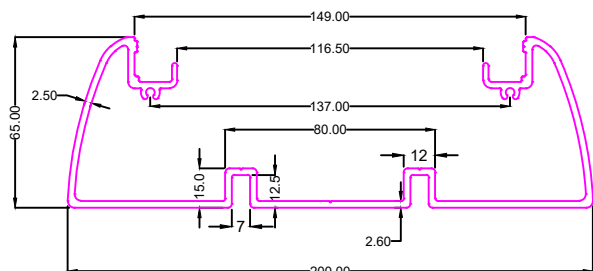



INDUSTRIAL

SEC No. MA8046

Weight:-12.150Kg/12'

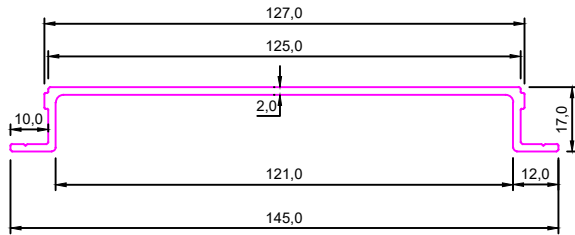

SEC No. 8062

Weight:-2.900Kg/12'



SEC No:-VA8080

Weight:-2.340Kg/12'

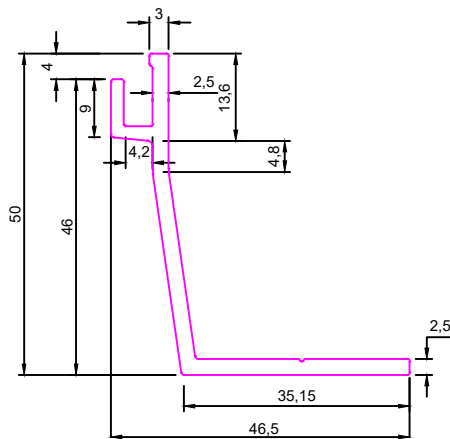

SEC No:-VA8081

Weight:-2.900Kg/12'

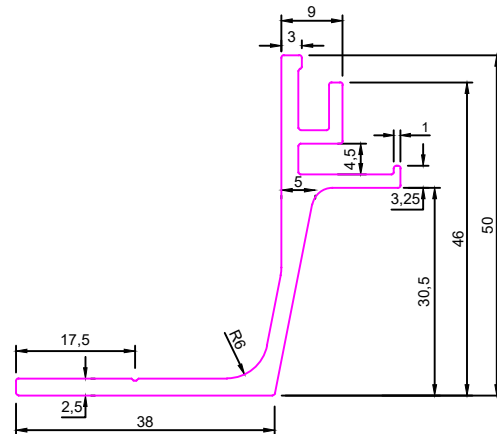

SEC No:-VA8082

Weight:-0.630Kg/12'

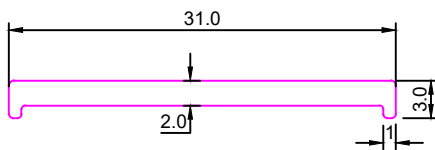

SEC No:-VA8083

Weight:-1.400Kg/12'

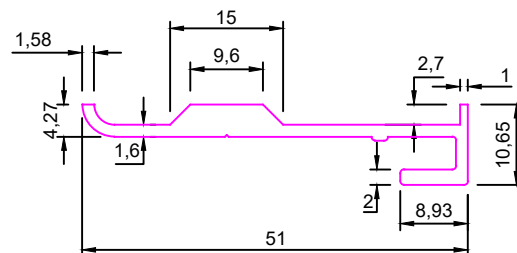



INDUSTRIAL

SEC No:-VA8084

Weight:-3.600Kg/12'

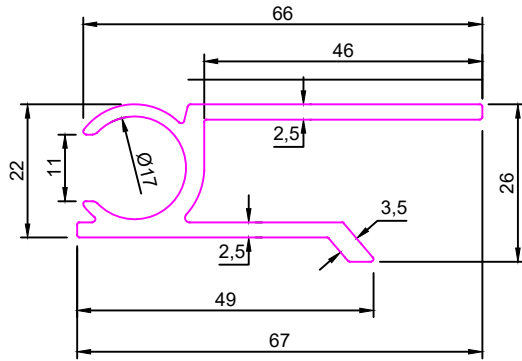

SEC No:-VA8085

Weight:-3.925Kg/12'

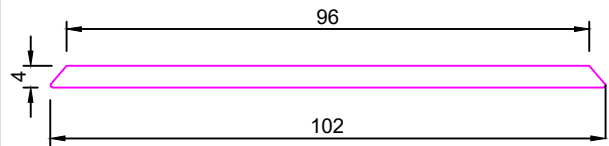

SEC No:-VA8086

Weight:-2.185Kg/12'

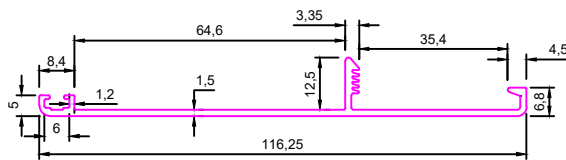

SEC No:-VA8087

Weight:-0.750Kg/12'

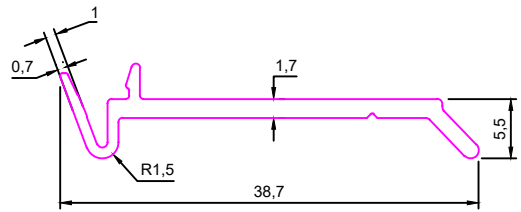

SEC No:-VA8088

Weight:-2.090Kg/12'

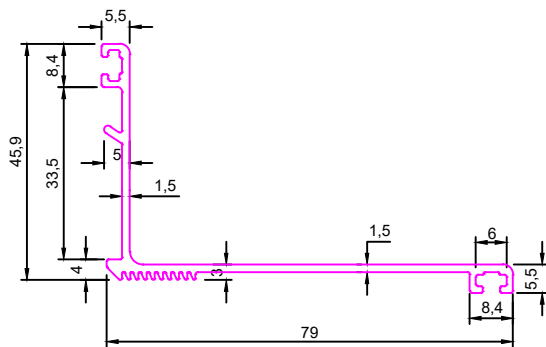

SEC No:-VA8089

Weight:-0.765Kg/12'

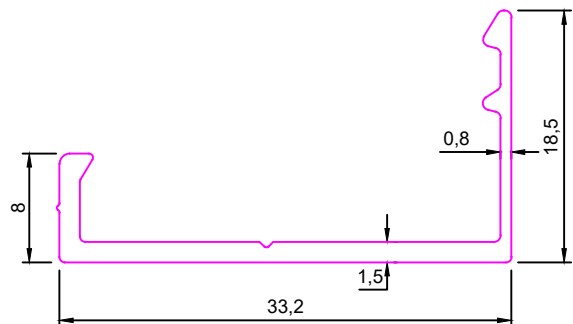



INDUSTRIAL

SEC No:-VA8090

Weight:-1.335Kg/12'

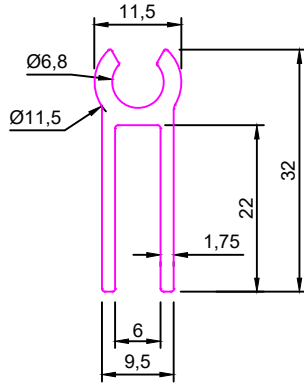

SEC No:-VA8091

Weight:-2.655Kg/12'

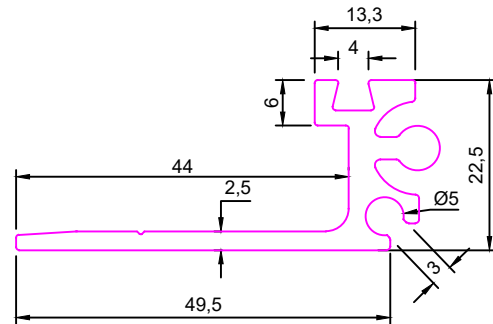

SEC No:-VA8092

Weight:-4.840Kg/12'

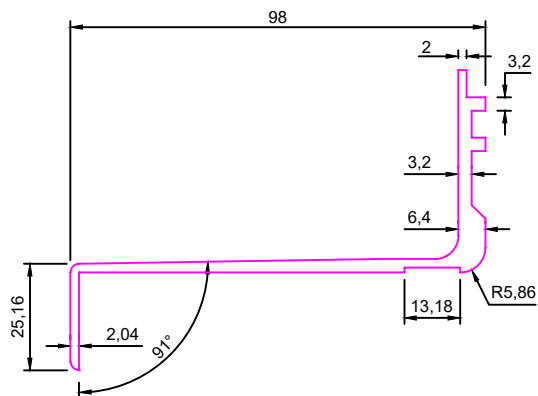

SEC No:-MA8093

Weight:-7.960Kg/12'

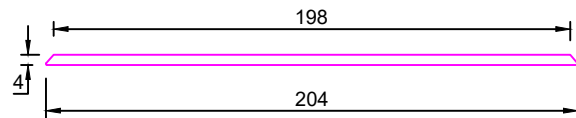

SEC No:-MA8094

Weight:-4.300Kg/12'

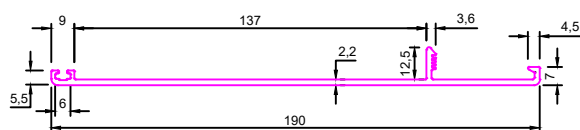

SEC No:-MA8095

Weight:-4.545Kg/12'

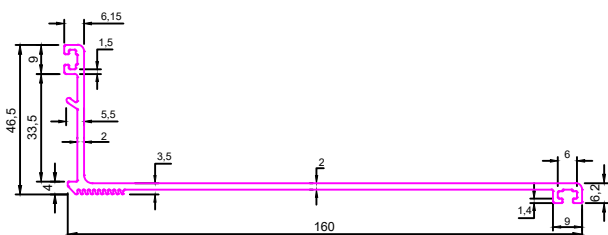



INDUSTRIAL

SEC No:-MA8096

Weight:-4.100Kg/12'

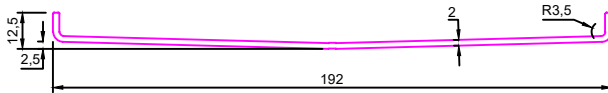

SEC No:-MA8097

Weight:-3.200Kg/12'

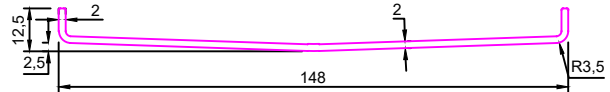

SEC No:-MA8098

Weight:-6.100Kg/12'

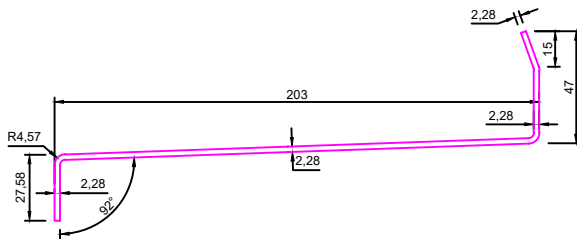

SEC No:- MA8105

Weight:-18.850Kg/12'

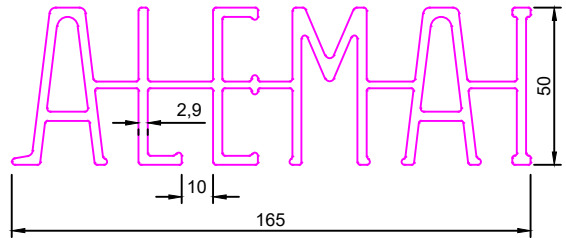

SEC No:- SA8108

Weight:-17.900Kg/12'

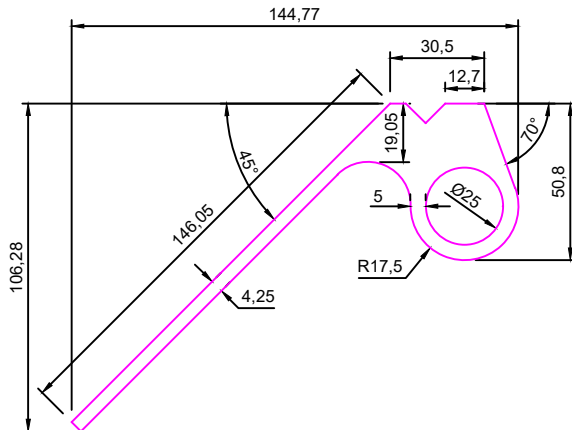

SEC No:- SA8109

Weight:-16.840Kg/12'

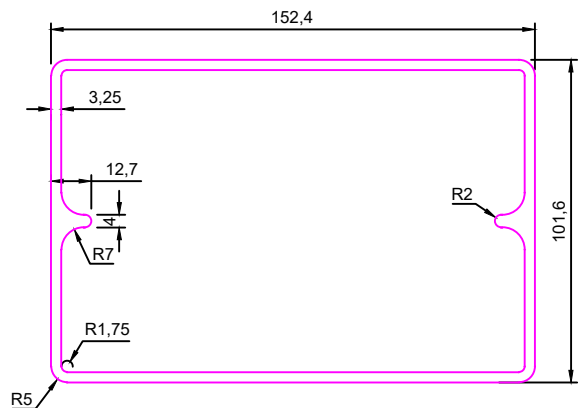



INDUSTRIAL

SEC No. 8142

Weight:-10.400Kg/12'

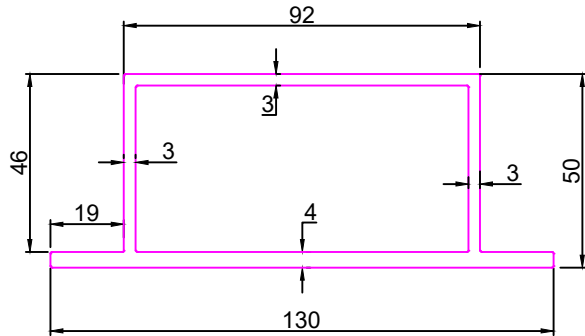

SEC No. 8169

Weight:-28.250Kg/12'

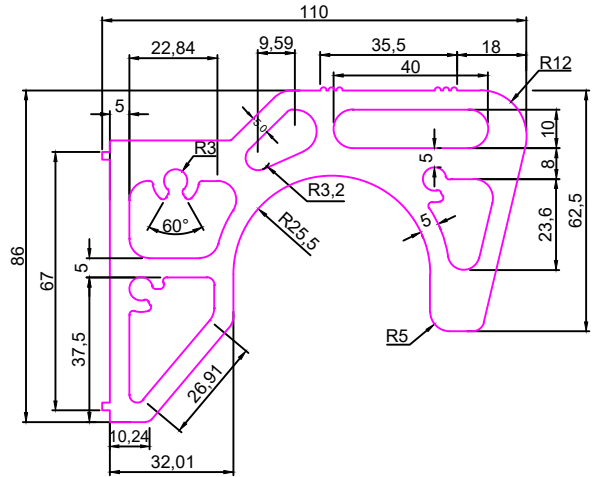

SEC No:-GA8170

Weight:5.250Kg/12'

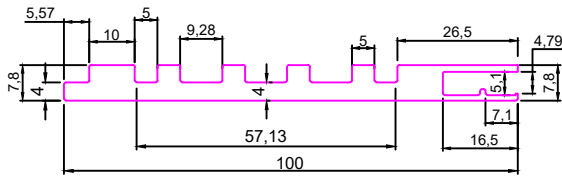

SEC No. 8195

Weight:-17.430Kg/12'

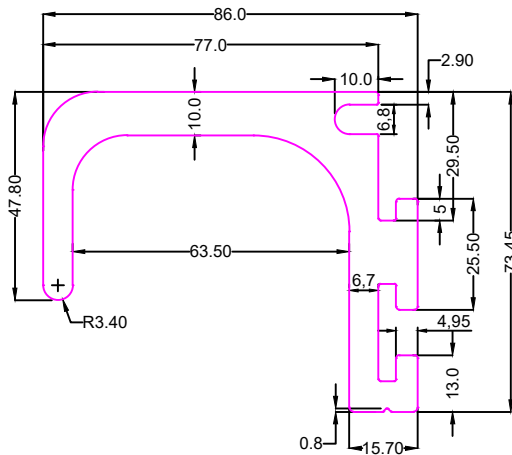

SEC No. 8197

Weight:-2.595Kg/12'

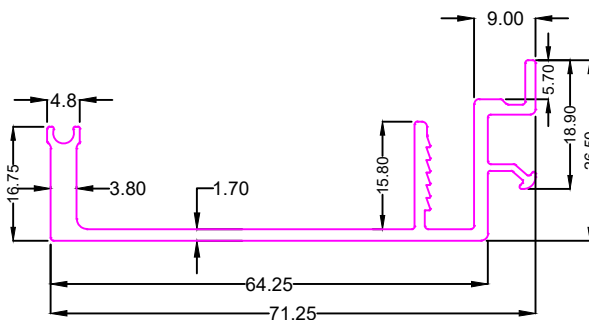

SEC No. 8198

Weight:-2.850Kg/12'

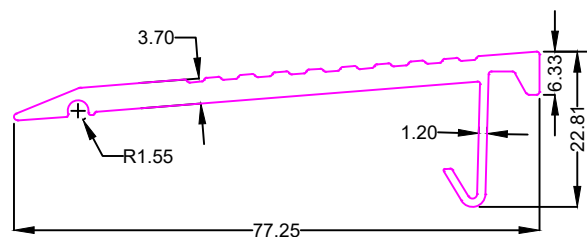



INDUSTRIAL

SEC No. 8199

Weight:-8.530Kg/12'

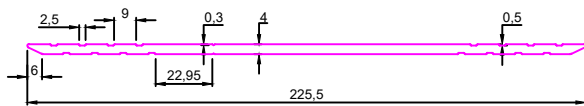

SEC No. 8213

Weight:-37.550Kg/12'

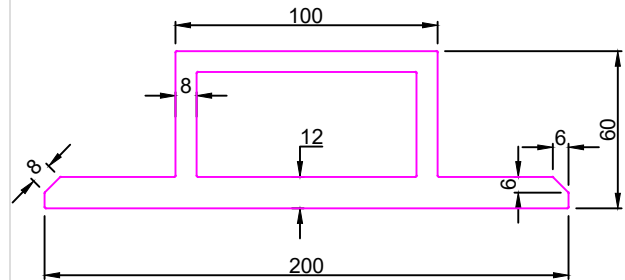

SEC No. :-8233

Weight:-4.290Kg/12'

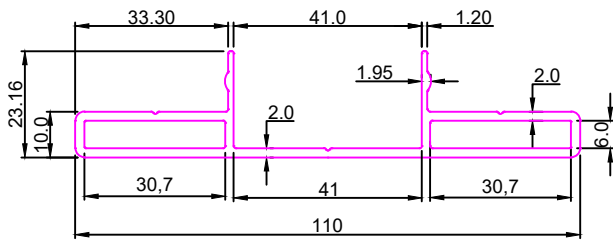

SEC No. :-8234

Weight:-11.490Kg/12'

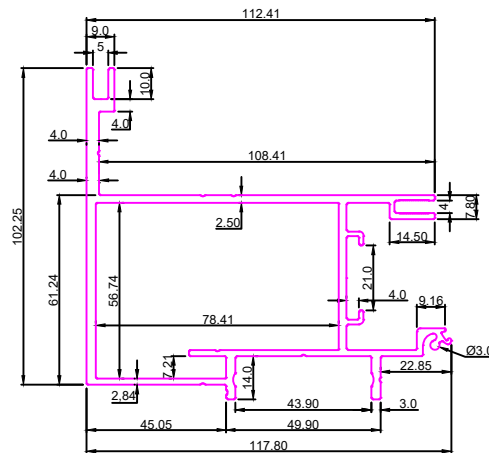

SEC No. :-GA8246

Weight:-11.750Kg/12'

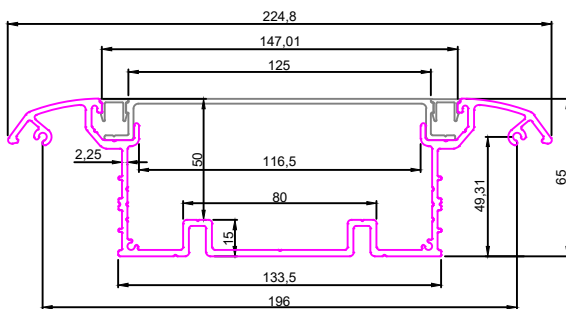

SEC No. :-GA8247

Weight:-12.600Kg/12'

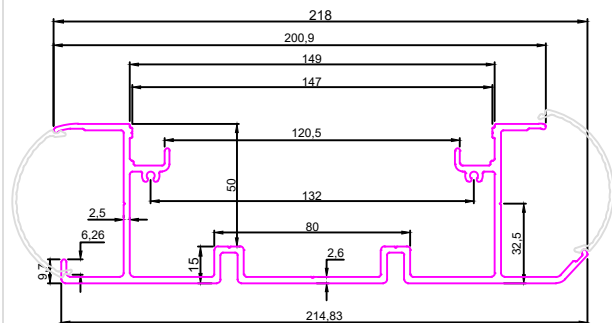



INDUSTRIAL

SEC No. :-GA8248

Weight:-12.500Kg/12'

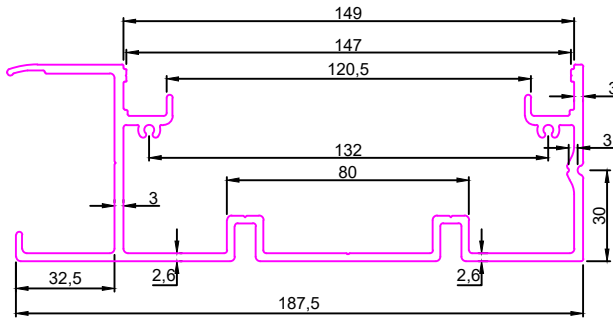

SEC No. :-8249

Weight:-1.000Kg/12'

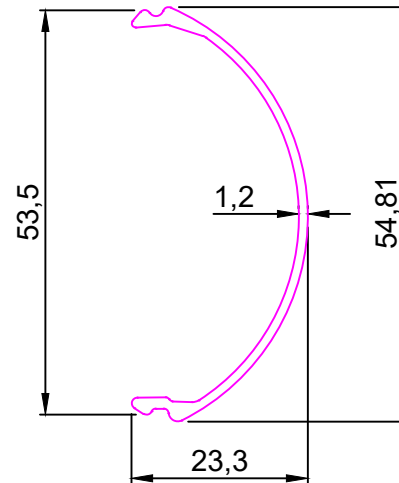

SEC No. :-8264

Weight:-8.300Kg/12'

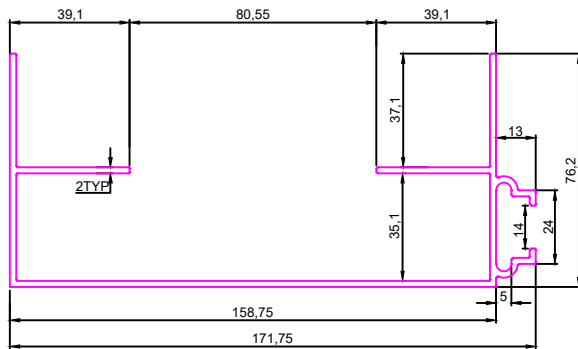

SEC No. :-MA8265

Weight:-2.820Kg/12'

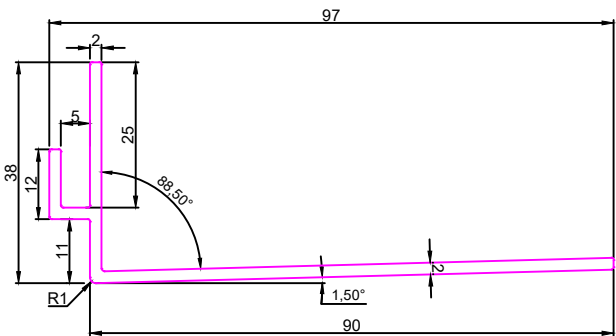

SEC No. :-8274

Weight:-0.650Kg/12'

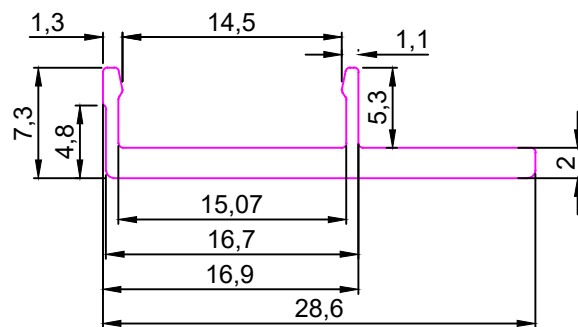

SEC No. :-8275

Weight:-6.000Kg/12'

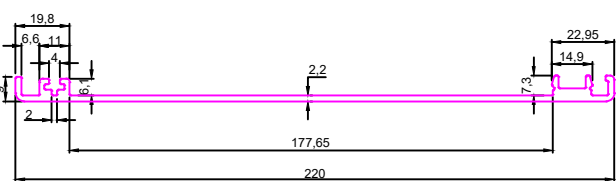



INDUSTRIAL

SEC No. :-8276

Weight:-13.00Kg/12'

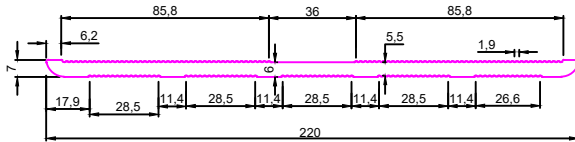

SEC No. :-8286

Weight:-11.900Kg/12'

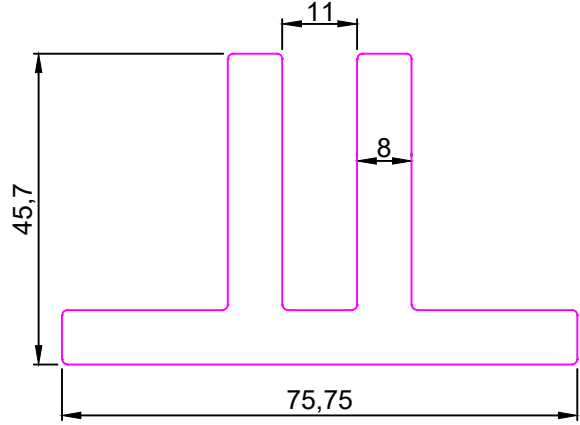

SEC No. 8298

Weight:-5.490Kg/12'

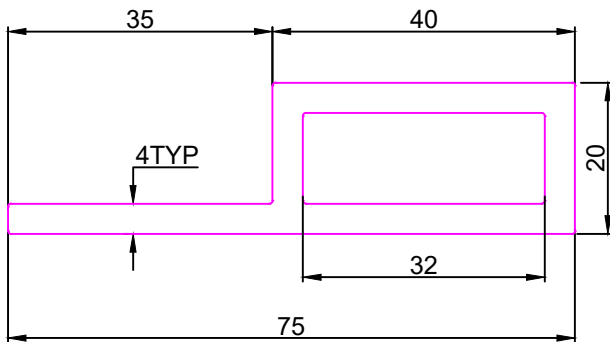

SEC No. 8318

Weight:-9.150Kg/12'

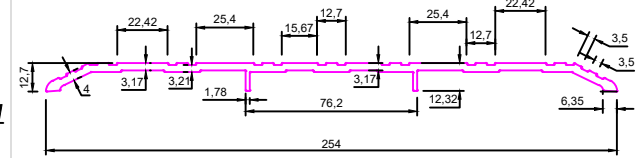

SEC No. 8322

Weight:-5.500Kg/12'

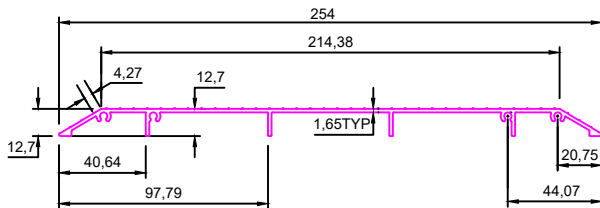

SEC No. 8323

Weight:-37.600Kg/12'

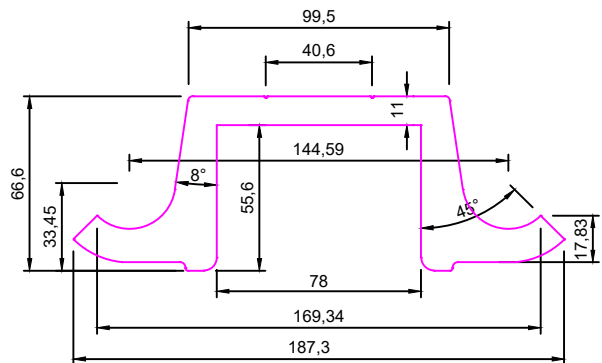



INDUSTRIAL

SEC No. 8326

Weight:-27.400Kg/12'

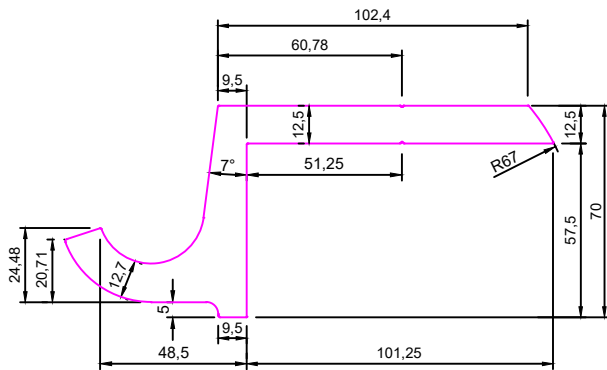

SEC No. 8337

Weight:-4.300Kg/12'

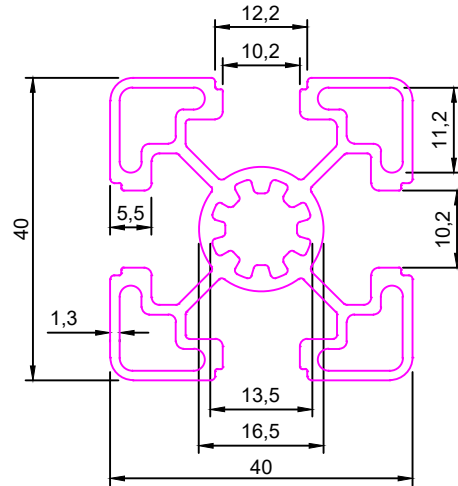

SEC No. 8338

Weight:-7.600Kg/12'

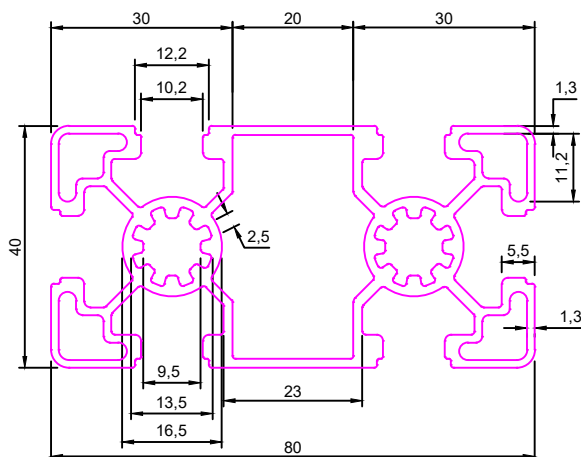

SEC No. 8339

Weight:-13.645Kg/12'

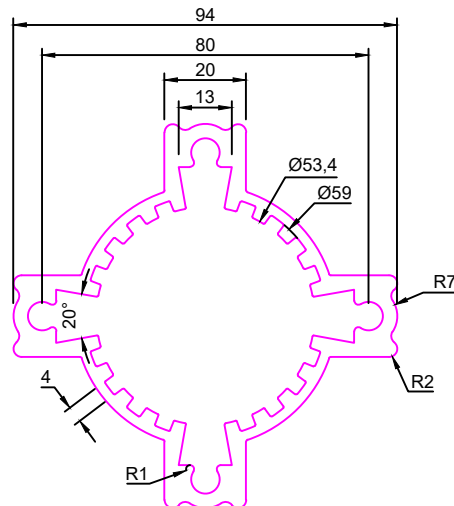

SEC No. 8346

Weight:-5.950Kg/12'

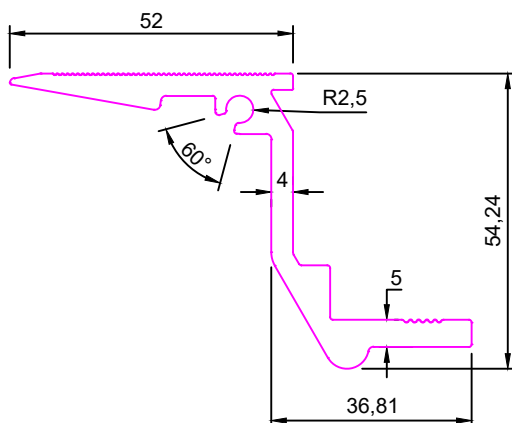

SEC No. 8347

Weight:-4.300Kg/12'

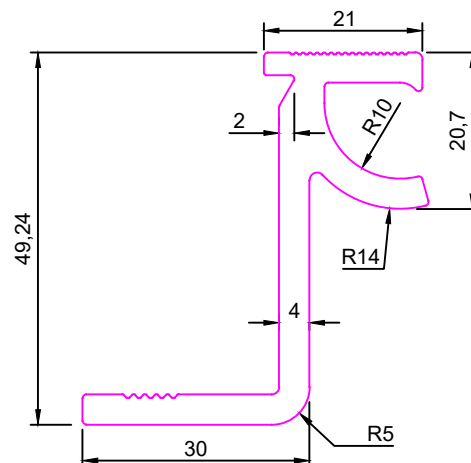



INDUSTRIAL

SEC No. 8348

Weight:-5.000Kg/12'

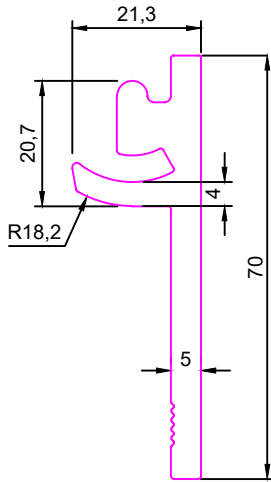

SEC No. 8349

Weight:-11.450Kg/12'

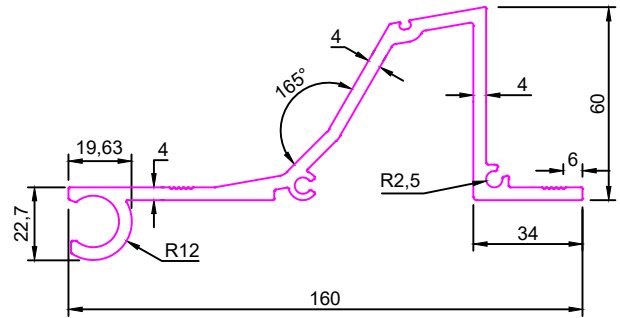

SEC No. 8350

Weight:-2.450Kg/12'

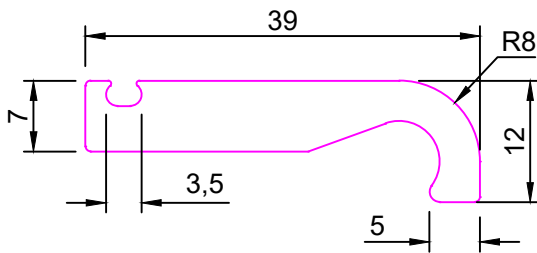

SEC No. 8351

Weight:-3.800Kg/12'

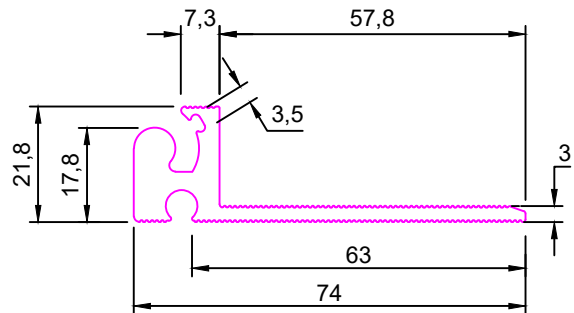

SEC No. 8352

Weight:-4.200Kg/12'

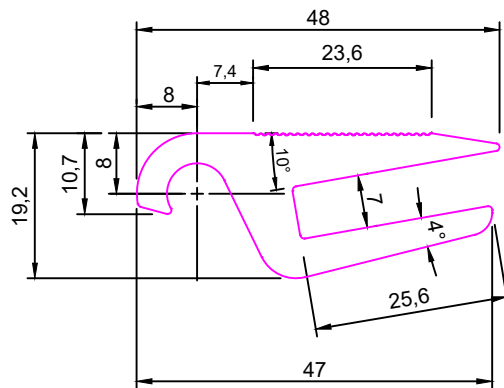

SEC No. 8353

Weight:-5.500Kg/12'

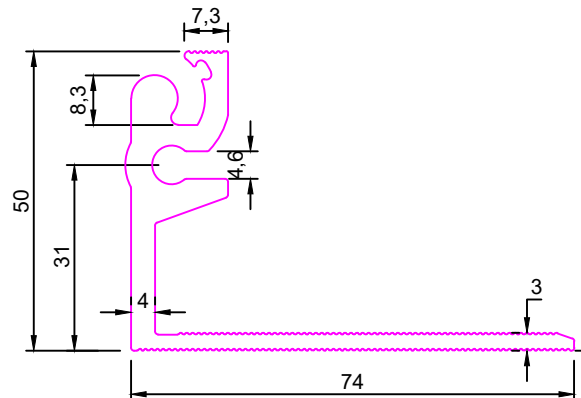



INDUSTRIAL

SEC No. 8354

Weight:-3.170Kg/12'

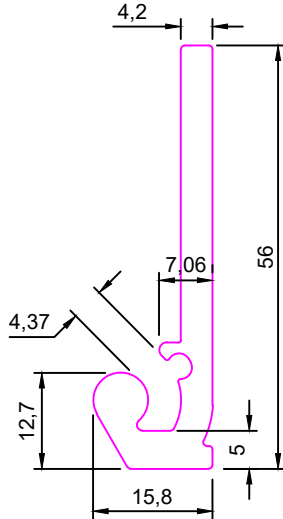

SEC No. 8369

Weight:-0.930Kg/12'

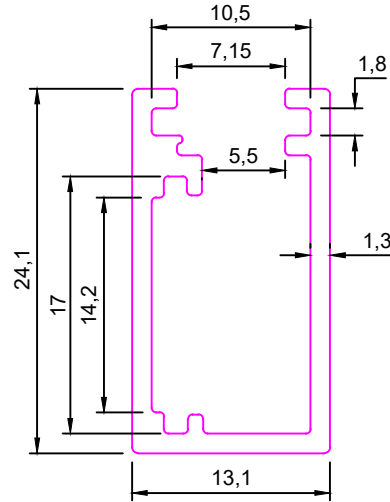

SEC No. 8370

Weight:-0.640Kg/12'

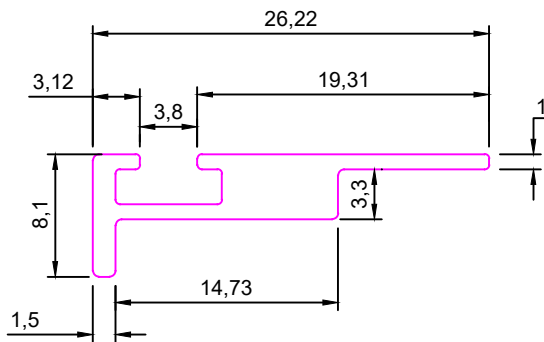

SEC No. 8371

Weight:-0.650Kg/12'

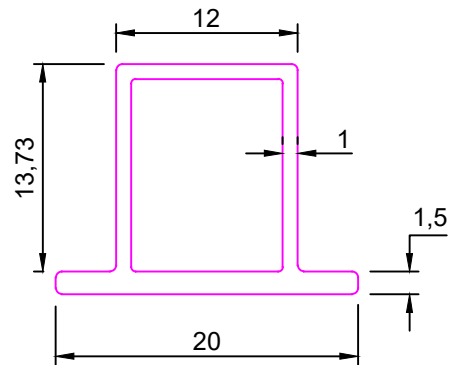



INDUSTRIAL

SEC No. 8384

Weight:-3.275Kg/12'

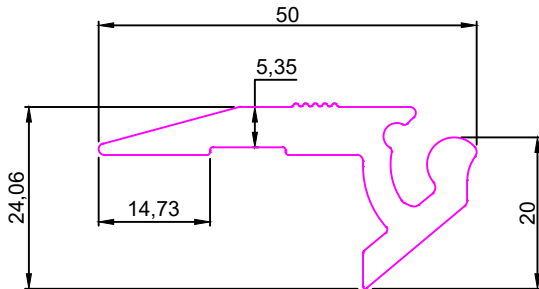

SEC No. 8385

Weight:-7.970Kg/12'

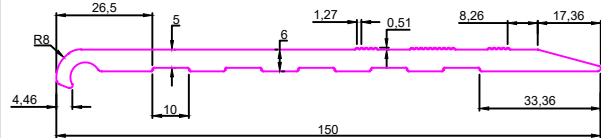

SEC No. 8386

Weight:-9.980Kg/12'

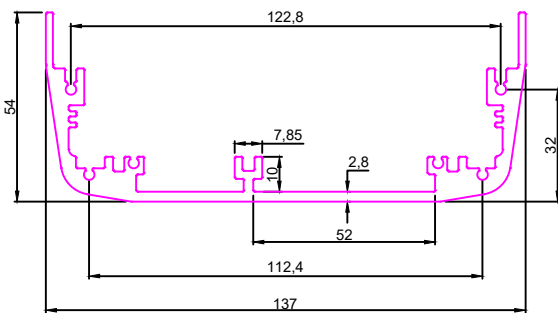

SEC No. 8400

Weight:-5.100Kg/12'

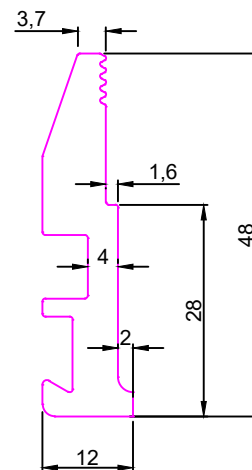

SEC No. 8401

Weight:-6.750Kg/12'

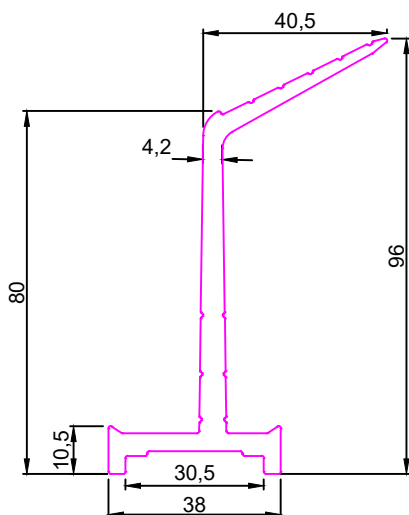

SEC No. 8402

Weight:-6.200Kg/12'

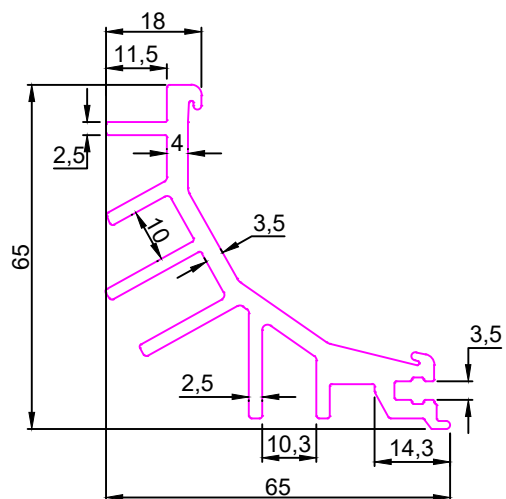



INDUSTRIAL

SEC No. 8477

Weight:-11.850Kg/12'

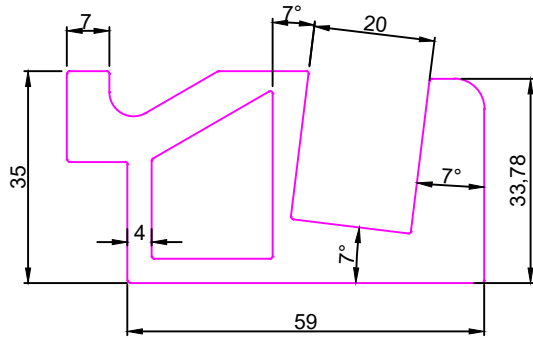

SEC No. 8478

Weight:-2.400Kg/12'

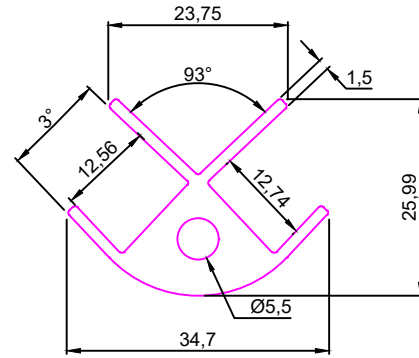

SEC No. 8485

Weight:-6.400Kg/12'

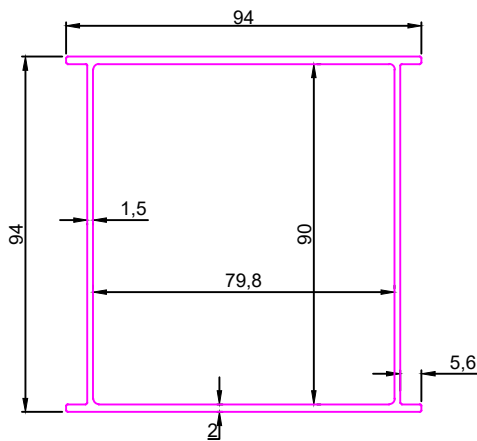

SEC No. 8488

Weight:-24.640Kg/12'

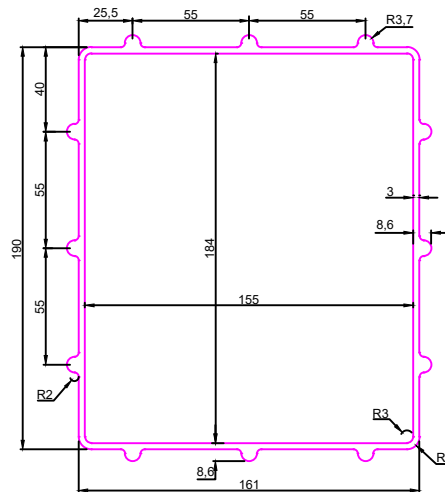

SEC No. VA8513

Weight:-5.700Kg/12'

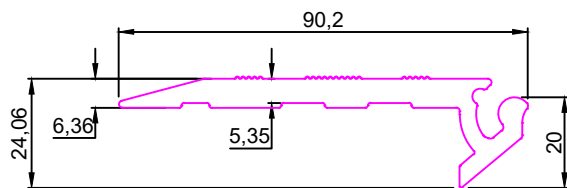

SEC No. VA8514

Weight:-10.640Kg/12'

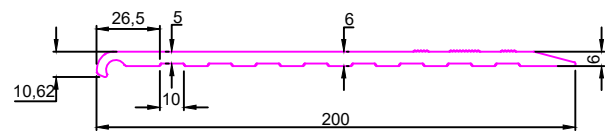



INDUSTRIAL

SEC No. VA8517

Weight:-308.600Kg/12'

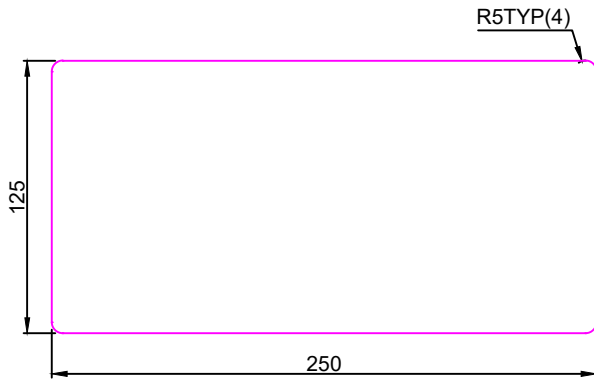

SEC No. 8519

Weight:-13.700Kg/12'

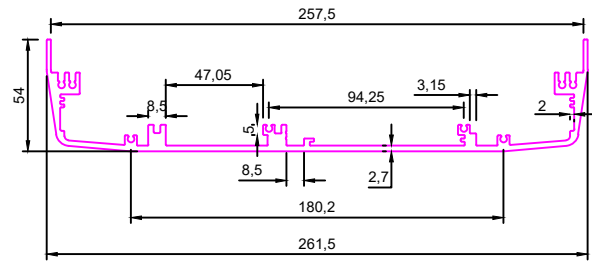

SEC No. 8520

Weight:-11.665Kg/12'

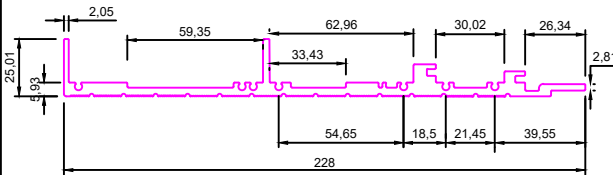

SEC No. 8561

Weight:33.660Kg/12'

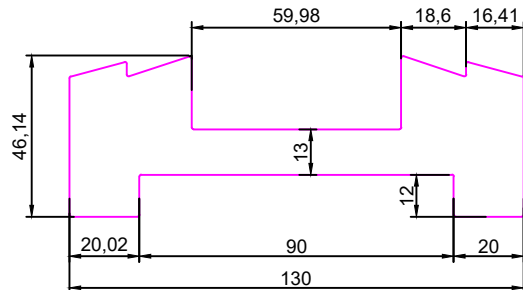

SEC No. 8581

Weight:18.465Kg/12'

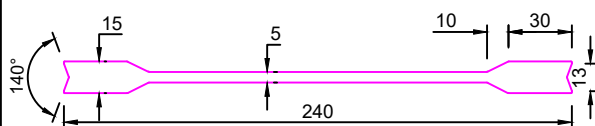

SEC No. 8636

Weight:8.230Kg/12'

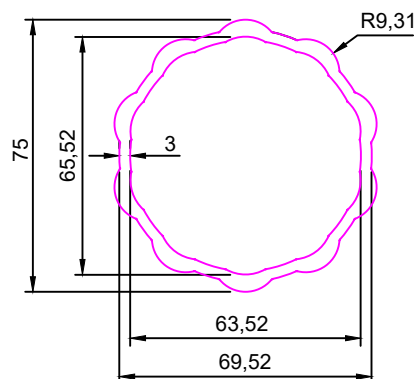



INDUSTRIAL

SEC No. 8637

Weight:1.265Kg/12'

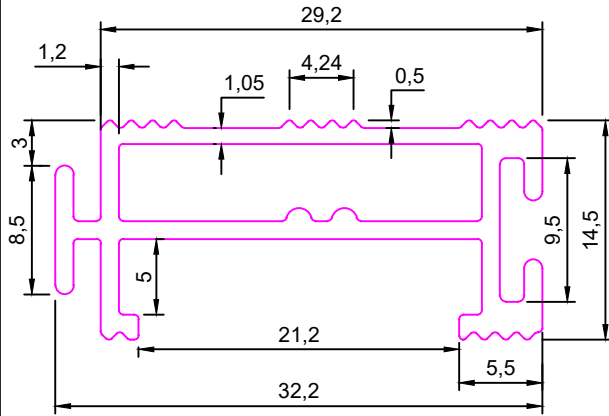

SEC No. 8644

Weight:3.200Kg/12'

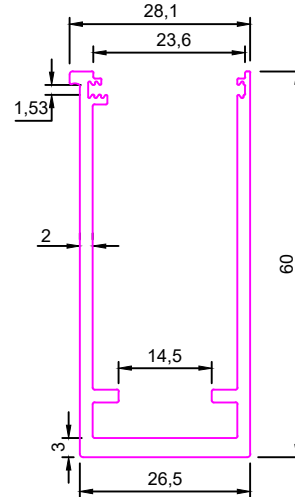

SEC No. 8654

Weight:4.385Kg/12'

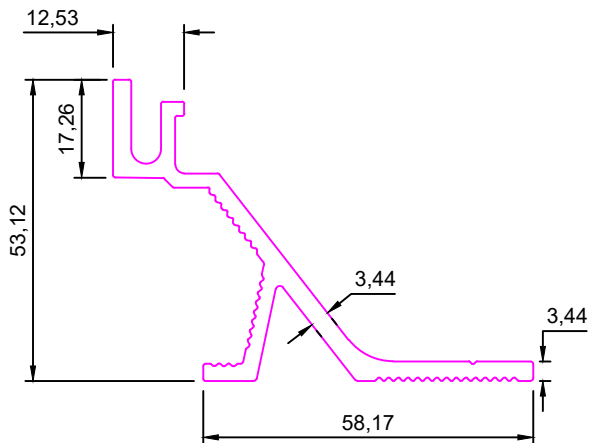

SEC No. 8655

Weight:4.240Kg/12'

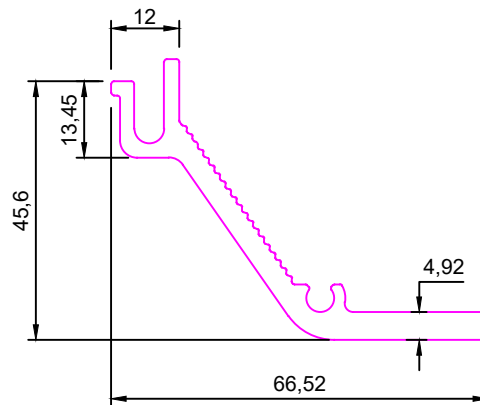

SEC No. 8656

Weight:2.290Kg/12'

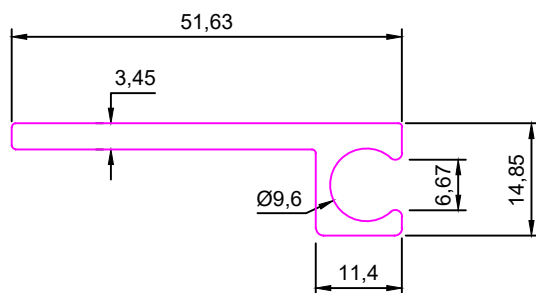

SEC No. 8657

Weight:11.400Kg/12'

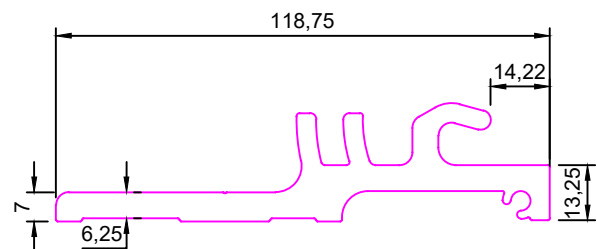



INDUSTRIAL

SEC No. 8658

Weight:5.440Kg/12'

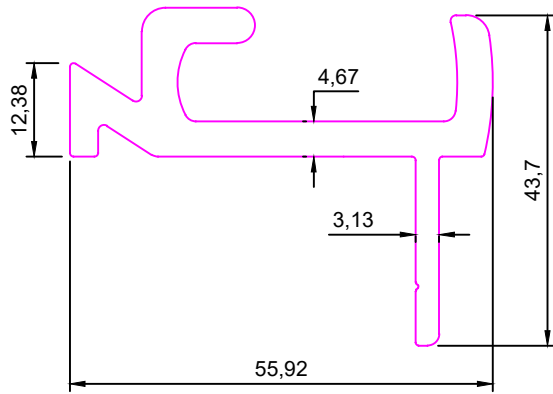

SEC No. 8659

Weight:1.115Kg/12'

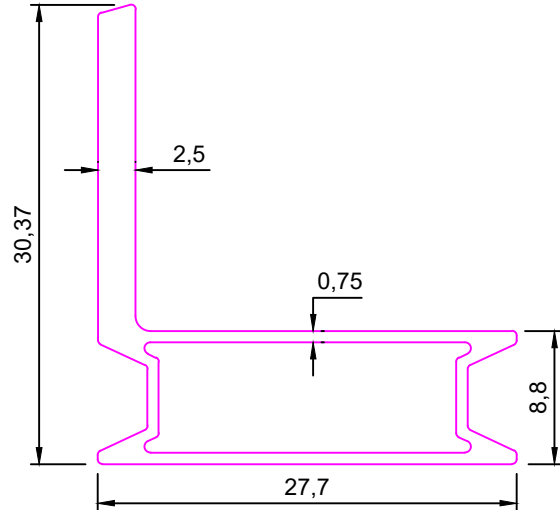

SEC No. 8660

Weight:3.380Kg/12'

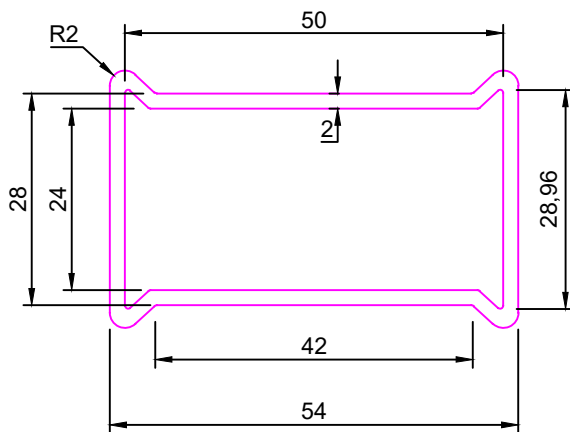

SEC No. 8661

Weight:1.840Kg/12'

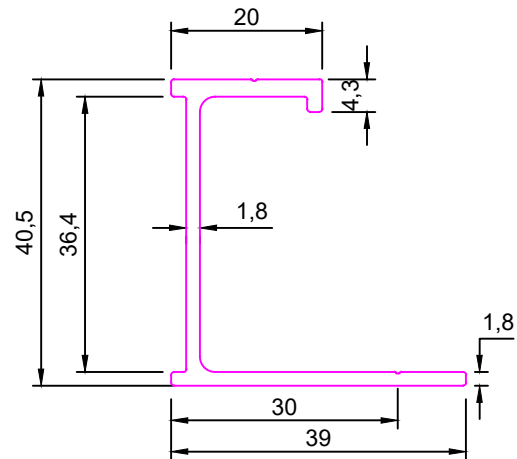

SEC No. SA8666

Weight:-48.500Kg/12'

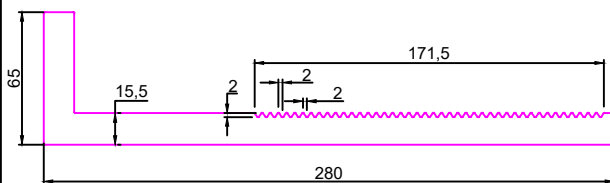

SEC No. SA8667

Weight:-33.870Kg/12'

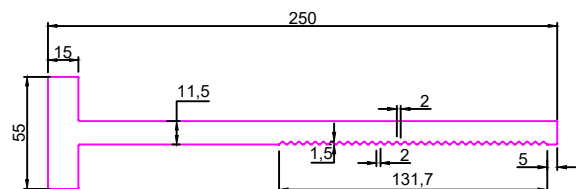



INDUSTRIAL

SEC No. 8719

Weight:-21.165Kg/12'

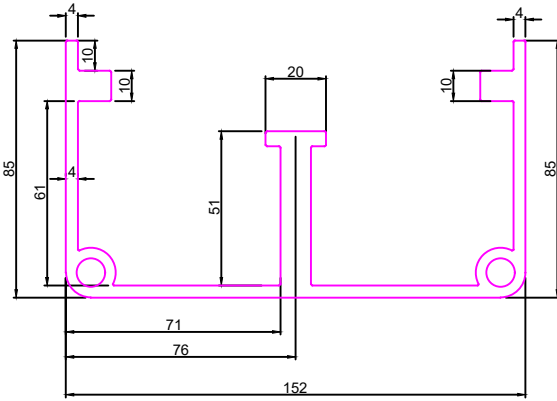

SEC No. 8720

Weight:-6.855Kg/12'

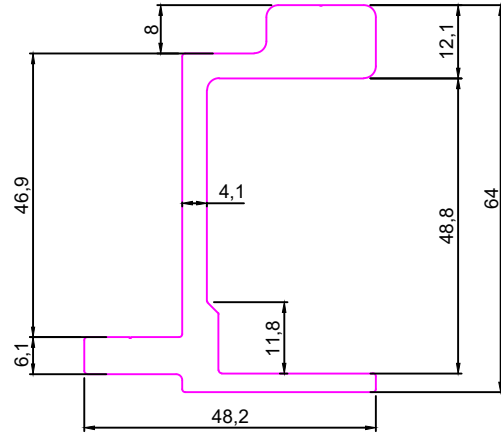

SEC No. 8721

Weight:-2.115Kg/12'

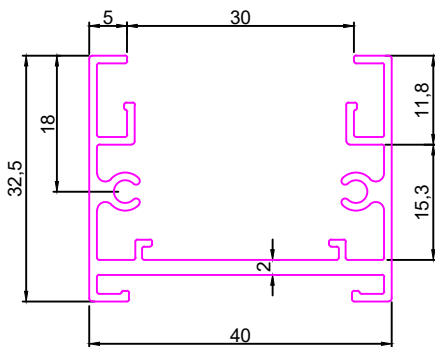

SEC No. 8722

Weight:-3.640Kg/12'

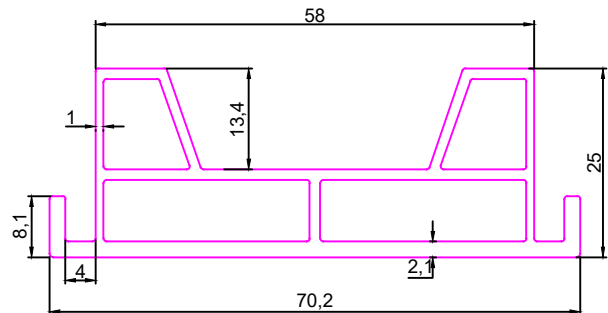

SEC No. SA8729

Weight:-38.585Kg/12'

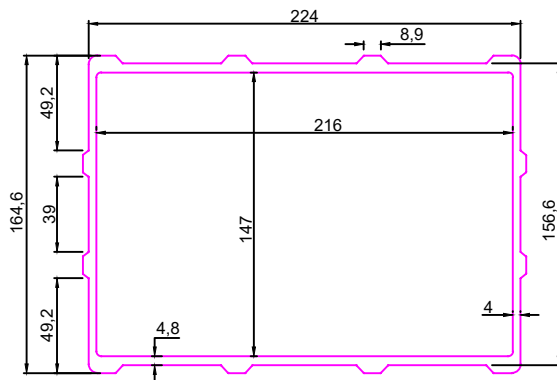

SEC No. 8733

Weight:-11.315Kg/12'

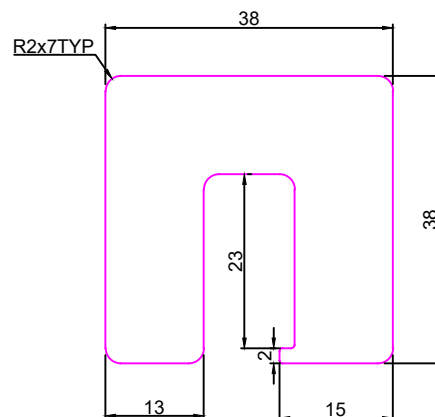



INDUSTRIAL

SEC No. 8734

Weight:-28.690Kg/12'

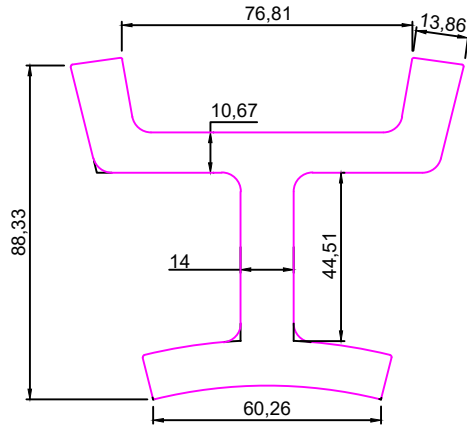

SEC No. MA8746

Weight:-10.440Kg/12'

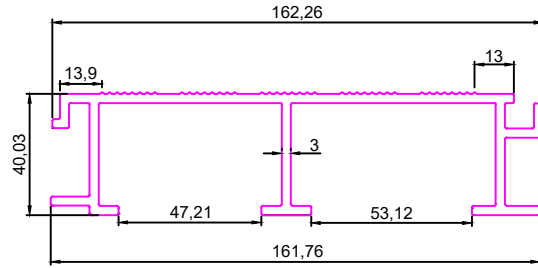

SEC No. MA8747

Weight:-12.600Kg/12'

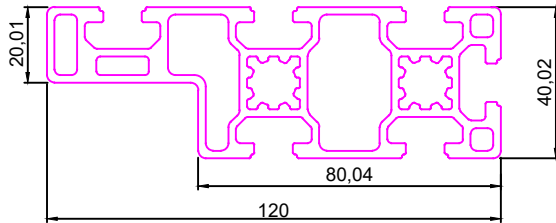

SEC No.:- 8749

Weight:-17.940Kg/12'

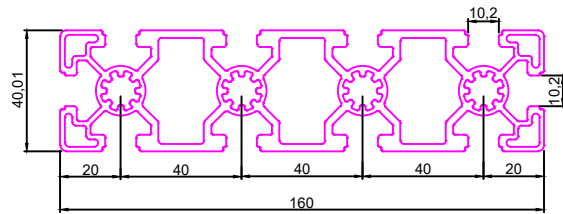

SEC No.:- 8752

Weight:-4.420Kg/12'

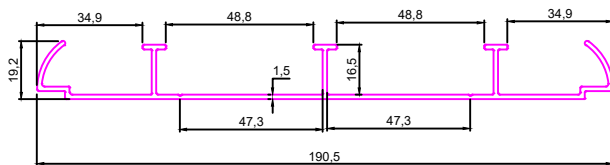

SEC No.:- 8754

Weight:-17.050Kg/12'

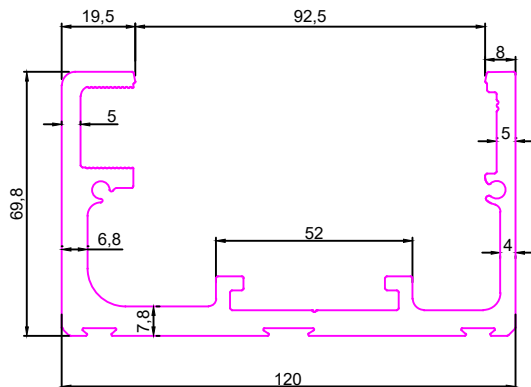



INDUSTRIAL

SEC No.:- 8767

Weight:-6.762Kg/12'

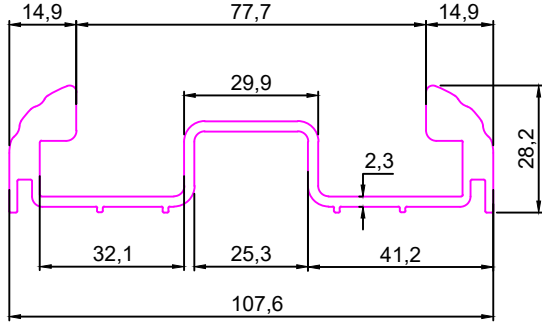

SEC No.:- 8768

Weight:-3.462Kg/12'

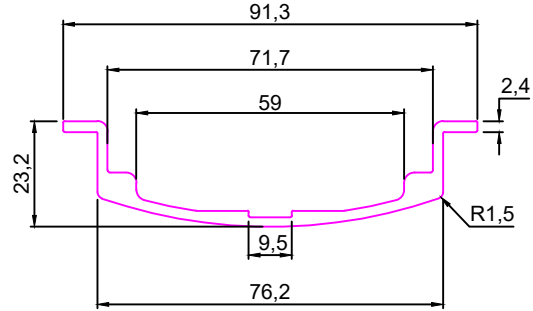

SEC No.:- 8769

Weight:-5.334Kg/12'

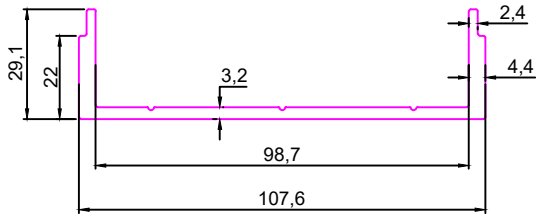

SEC No.:- 8770

Weight:-6.432Kg/12'

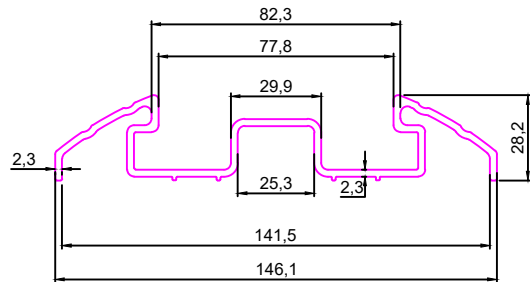

SEC No.:- 8771

Weight:-6.559Kg/12'

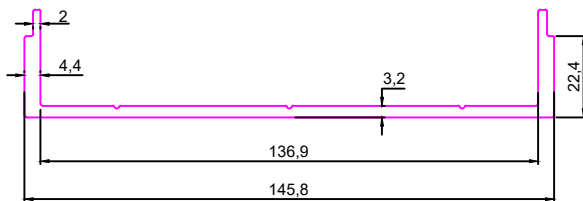

SEC No.:- 8775

Weight:-48.000Kg/12'

