

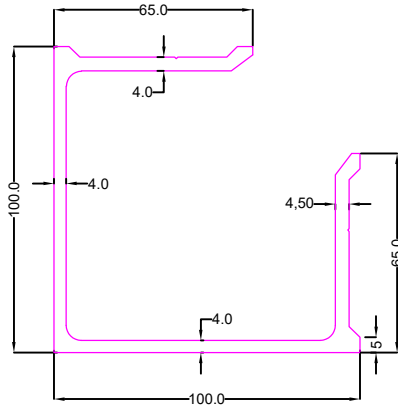

FORM WORKS

SEC. NO:- 7023

Weight :- 13.950kg/12'



SEC No. 7024

Weight-19.300kg/12'

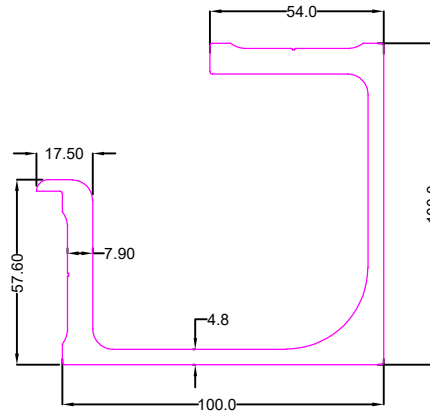

SEC. NO:- 7025

Weight :- 16.675kg/12'

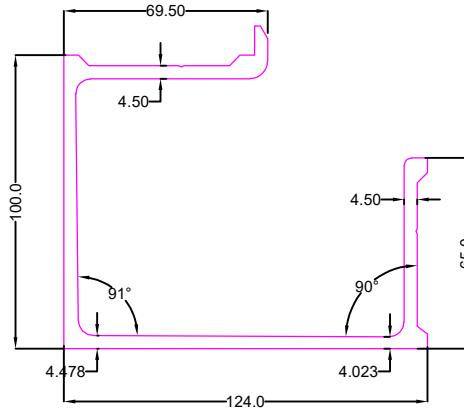

SEC. NO:- 7027

Weight :- 13.385kg/12'

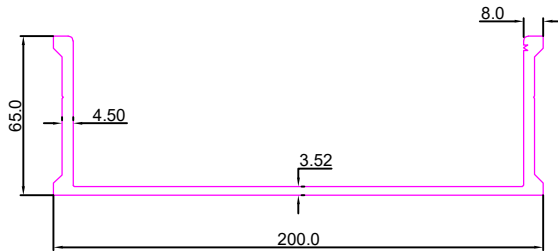

SEC No. 7028

Weight-14.270kg/12'

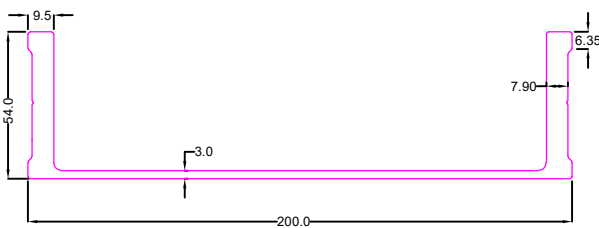

SEC. NO:- 7029

Weight :- 12.480kg/12'

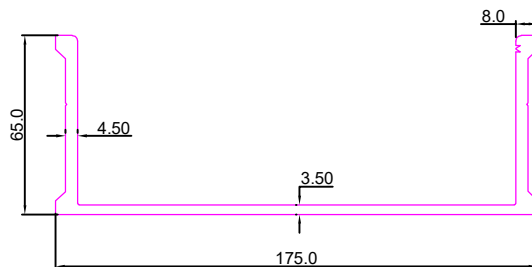



FORM WORKS

SEC No. 7151

Weight-2.050kg/12'

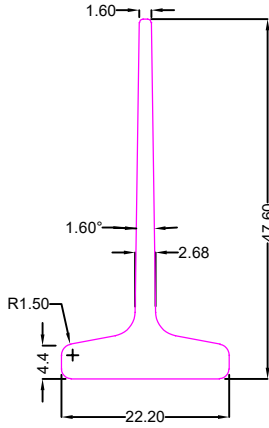

SEC No. 7160

Weight-16.650kg/12'

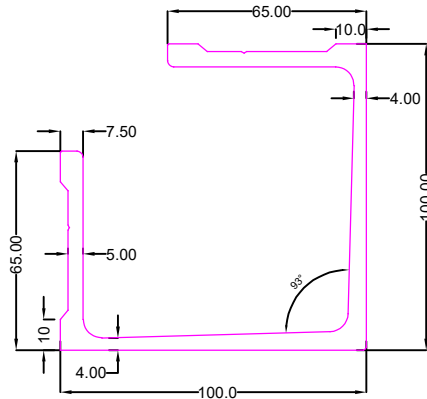

SEC No. 7161

Weight-17.900kg/12'

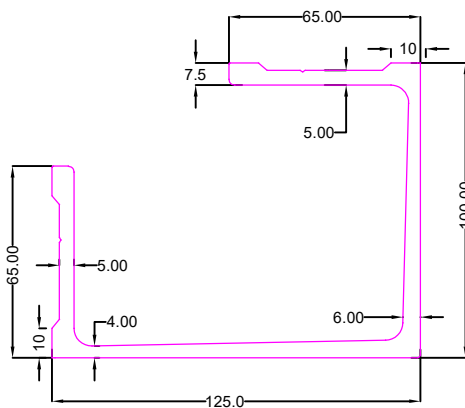

SEC No. 7162

Weight-18.650kg/12'

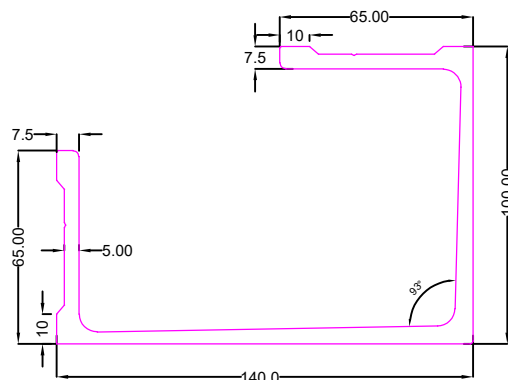

SEC No. 7163

Weight-19.150kg/12'

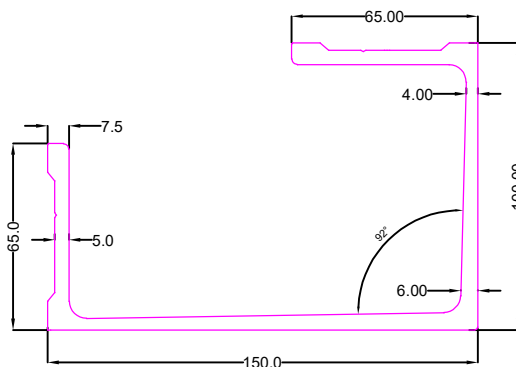

SEC No. 7164

Weight-20.350kg/12'

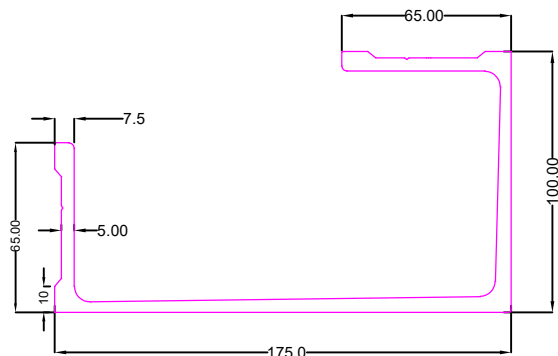



FORM WORKS

SEC No. 7165

Weight-21.600kg/12'

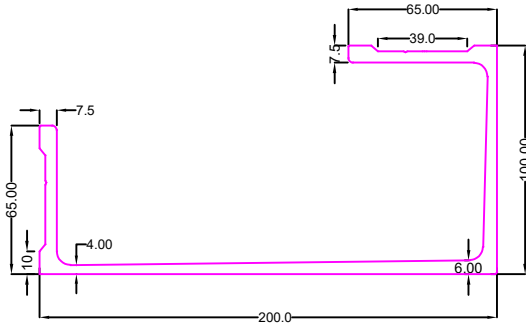

SEC No. 7166

Weight-10.625kg/12'

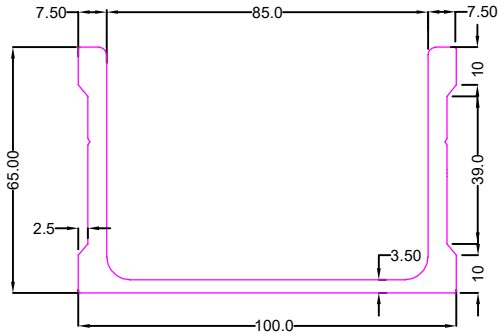

SEC No. 7167

Weight-11.825kg/12'

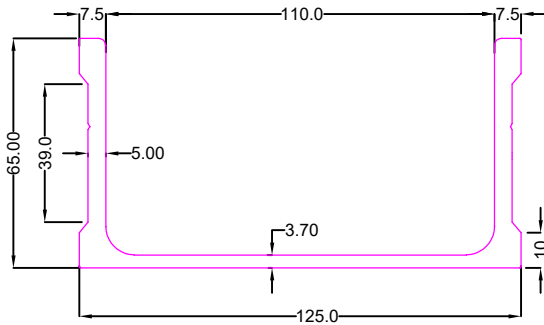

SEC No. 7168

Weight-12.350kg/12'

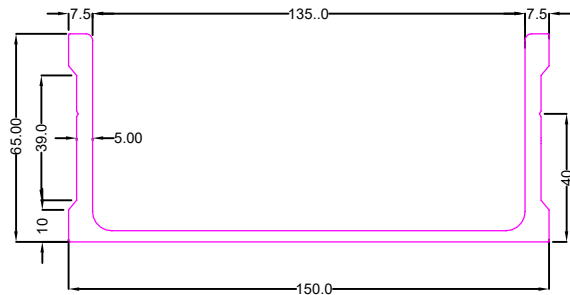

SEC No. 7169

Weight-14.565kg/12'

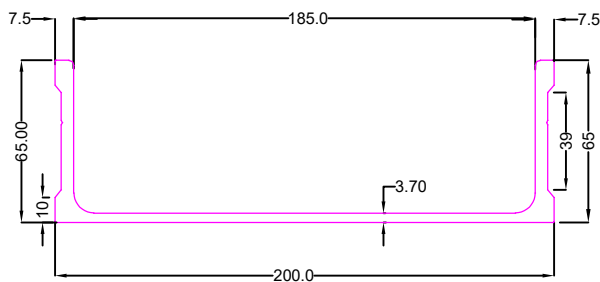

SEC No. 7170

Weight-16.350kg/12'

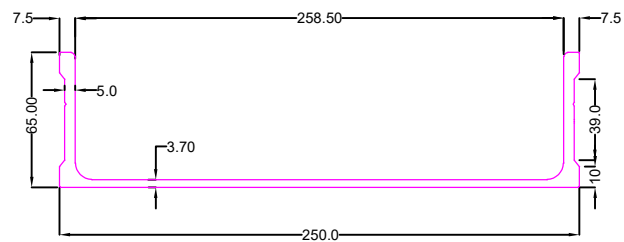



FORM WORKS

SEC No. 7171

Weight-16.750kg/12'

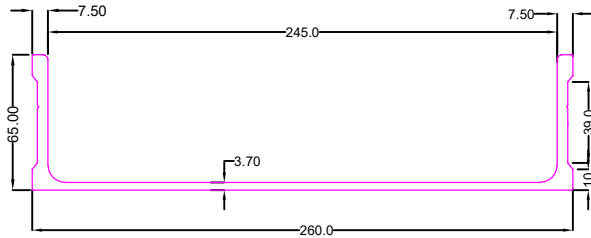

SEC No. 7172

Weight-19.00kg/12'

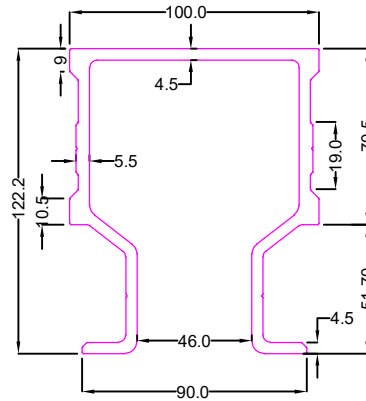

SEC No. 7173

Weight-19.850kg/12'

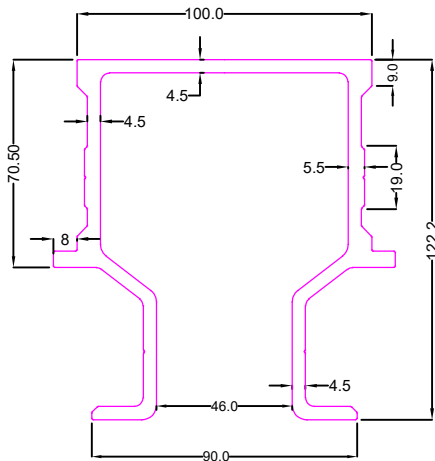

SEC No. 7174

Weight-1.900kg/12'

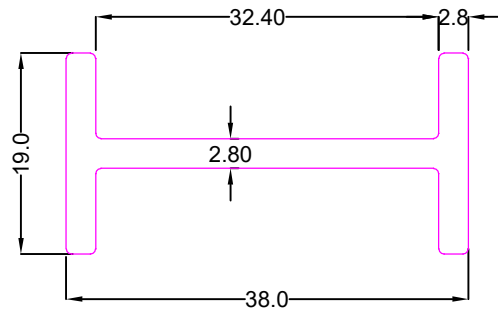

SEC No. 7175

Weight-3.250kg/12'

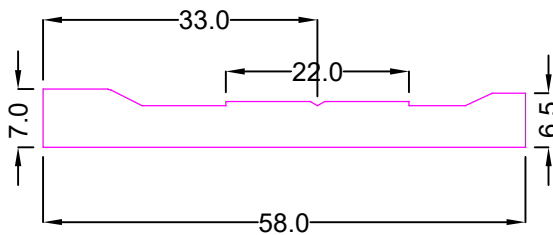

SEC No. 7176

Weight-6.450kg/12'

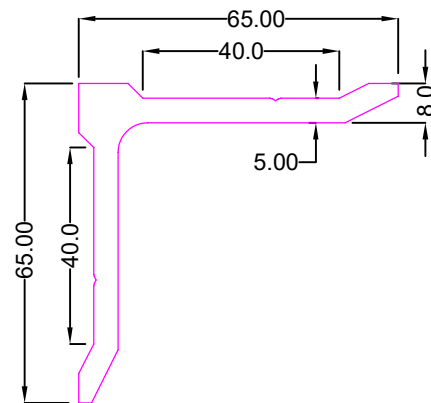



FORM WORKS

SEC No. 7188

Weight-17.500kg/12'

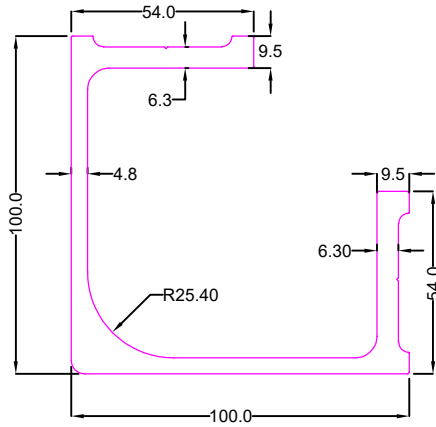

SEC No. 7189

Weight-20.00kg/12'

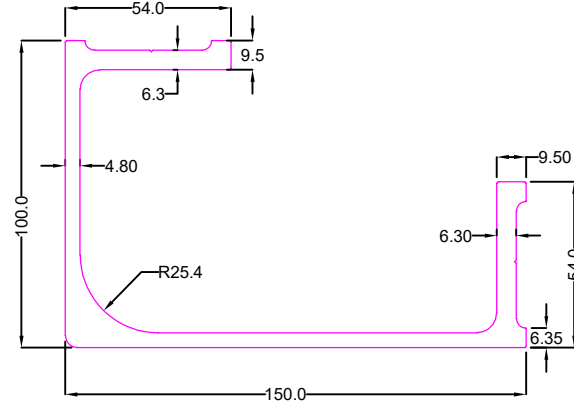

SEC No. 7353

Weight-14.845kg/12'

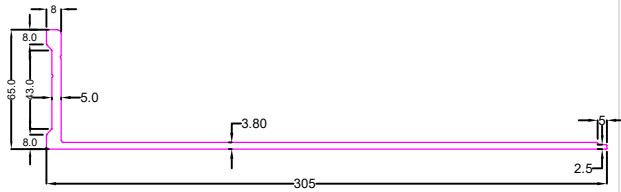

SEC No. 7391

Weight-16.350kg/12'

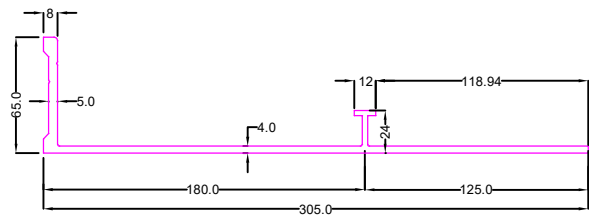

SEC No. 7392

Weight-14.550kg/12'

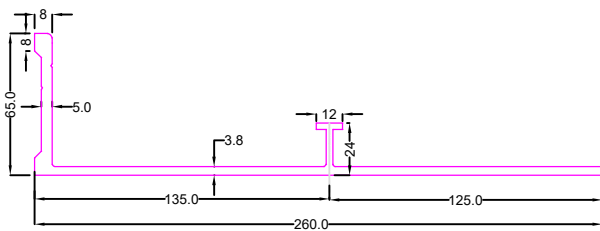

SEC No. 7393

Weight-13.585kg/12'

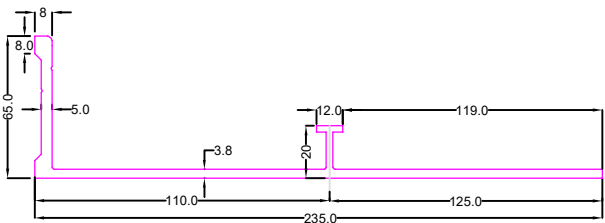



FORM WORKS

SEC No. 7394

Weight-12.600kg/12'

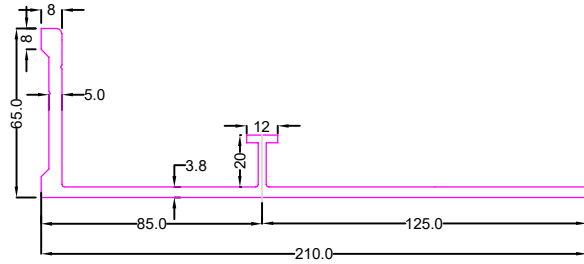

SEC No. 7395

Weight-16.550kg/12'

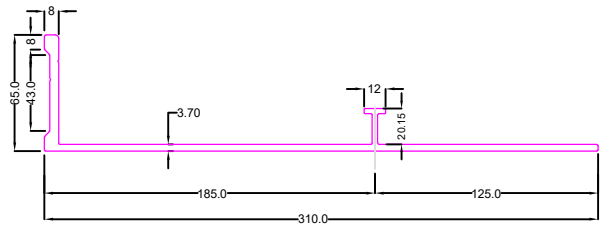

SEC No. 7396

Weight-2.360kg/12'

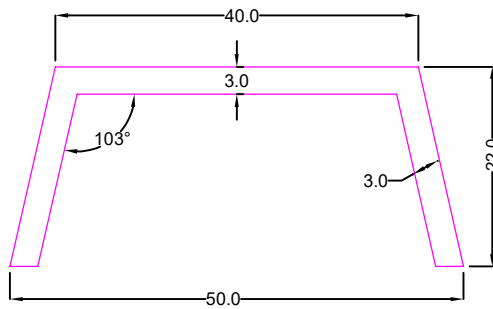

SEC No. 7397

Weight-4.050kg/12'

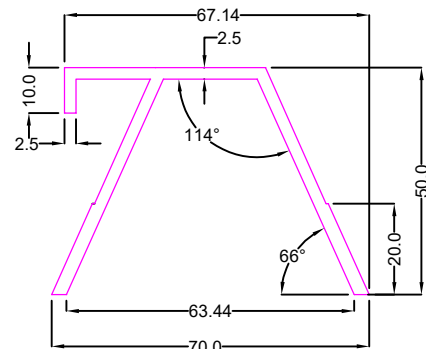

SEC No. 7398

Weight-2.200kg/12'

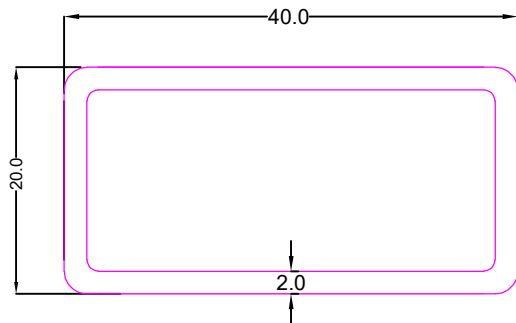

SEC No. 7399

Weight-15.775kg/12'

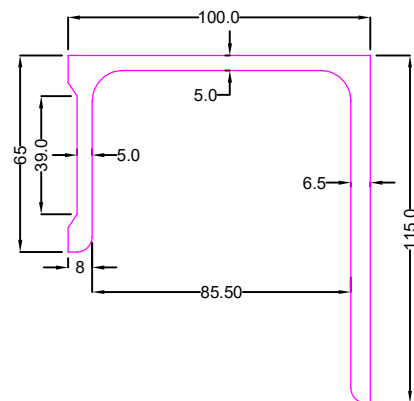



FORM WORKS

SEC No. 7400

Weight-5.600kg/12'

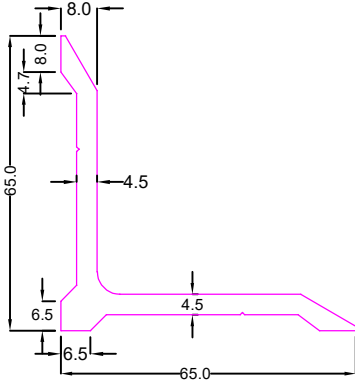

SEC No. 7401

Weight-15.600kg/12'

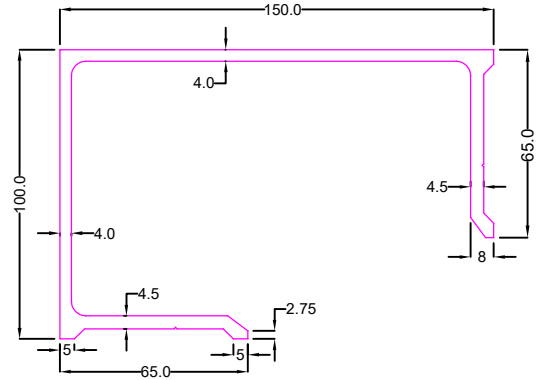

SEC No. 7402

Weight-3.550kg/12'

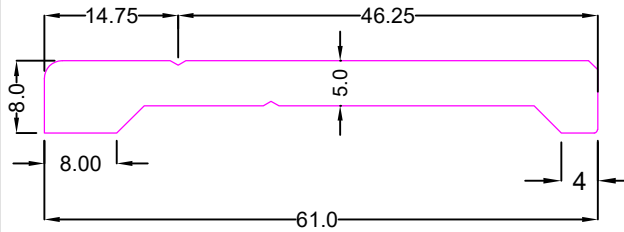

SEC No. 7403

Weight-3.700kg/12'

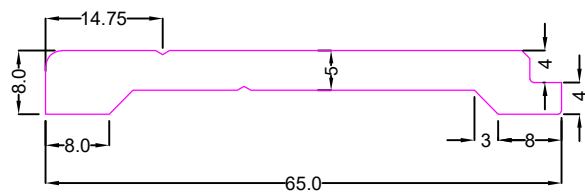

SEC No. 7418

Weight-18.450kg/12'

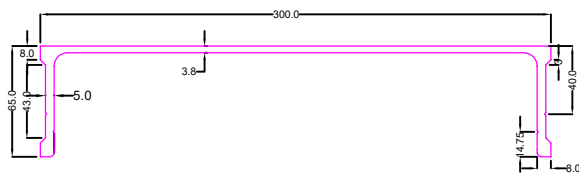

SEC No.7429

Weight-14.675kg/12'

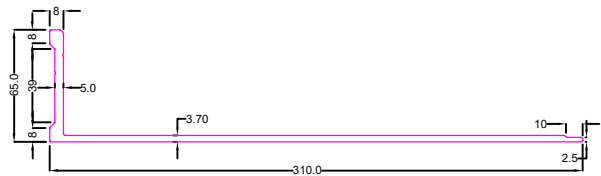



FORM WORKS

SEC No.7432

Weight-15.550kg/12'

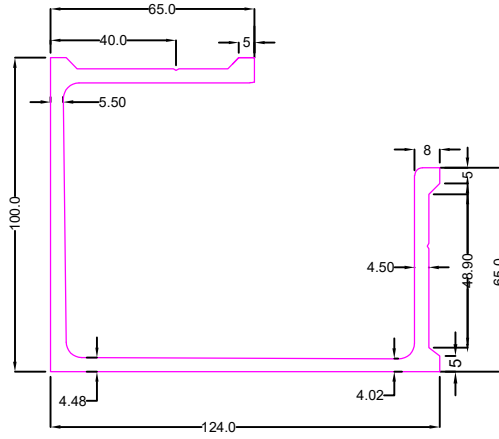

SEC No.7433

Weight-17.100kg/12'

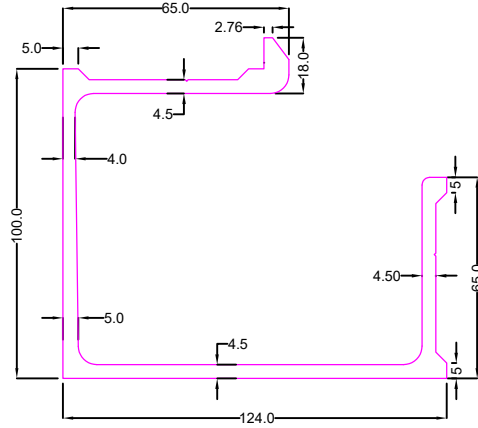

SEC No.7434

Weight-10.100kg/12'

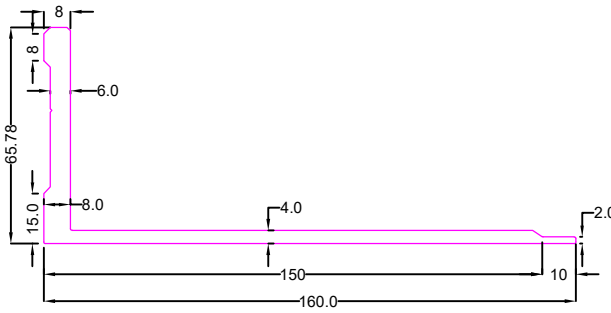

SEC No.7435

Weight-11.100kg/12'

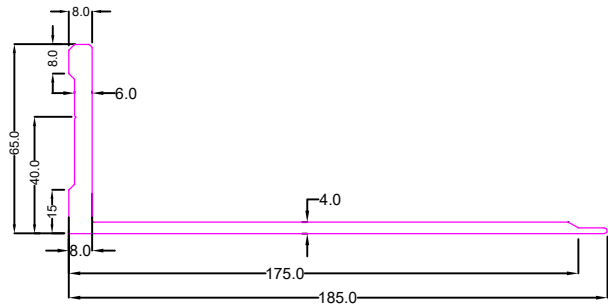

SEC No.7436

Weight-11.750kg/12'

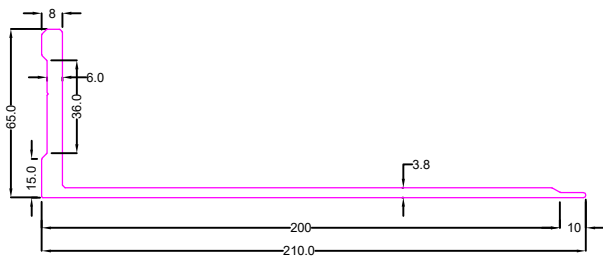

SEC No. 7452

Weight-2.195kg/12'

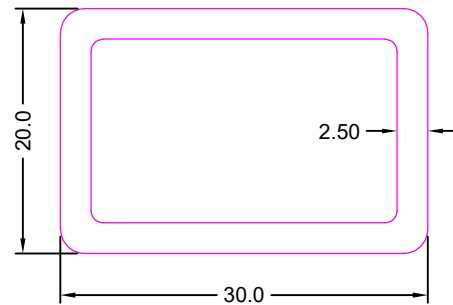



FORM WORKS

SEC No. 7469

Weight-13.050kg/12'

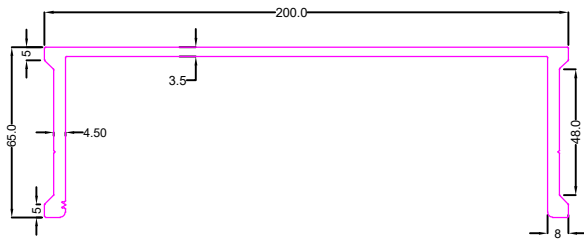

SEC No. 7487

Weight-14.675kg/12'

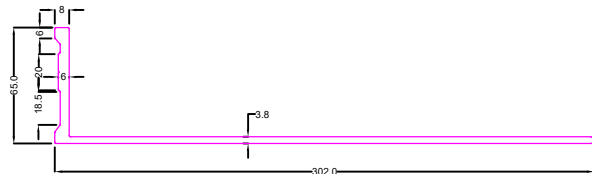

SEC No. 7496

Weight-15.400kg/12'

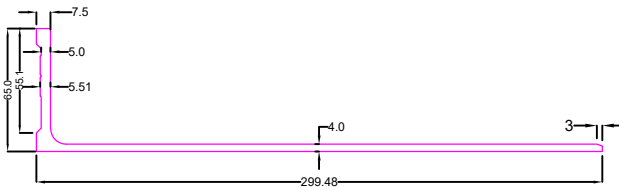

SEC No. 7500

Weight-3.765kg/12'

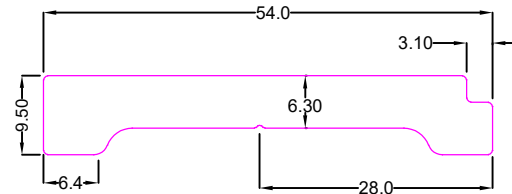

SEC. NO:- 7625

Weight :- 10.650kg/12'

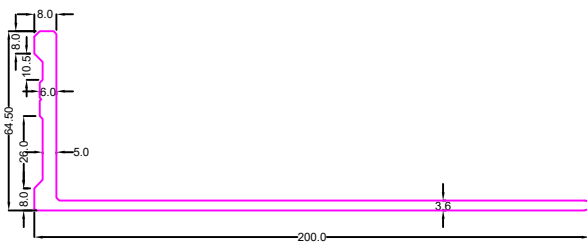

SEC. NO:- 7626

Weight :- 11.550kg/12'

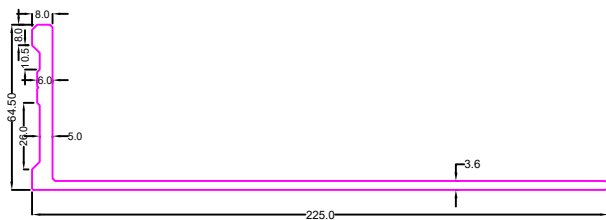



FORM WORKS

SEC. NO:- 7627

Weight :- 12.400kg/12'

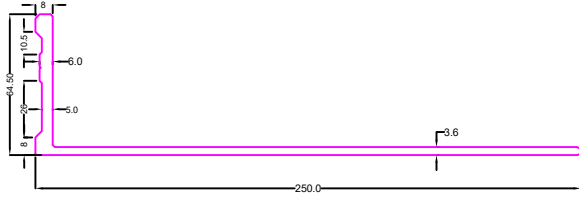

SEC. NO:- 7628

Weight :- 13.300kg/12'

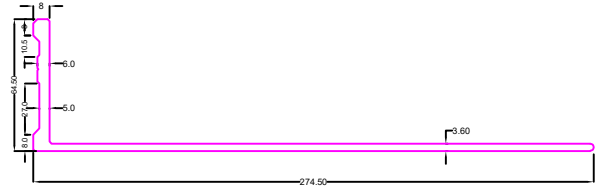

SEC No. 7647

Weight:-5.770Kg/12'

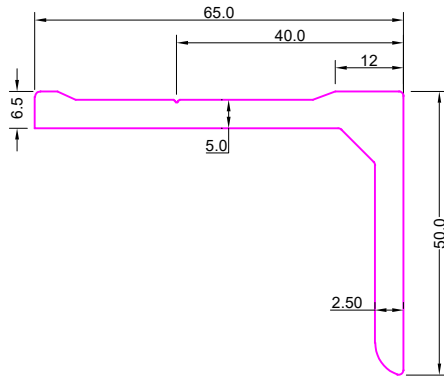

SEC No. 7650

Weight:-15.450Kg/12'

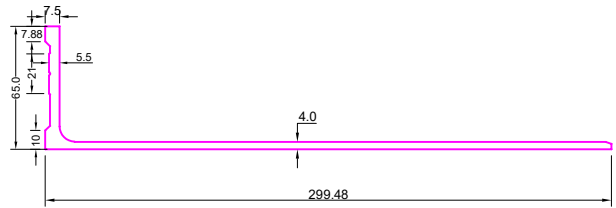

SEC. NO:- 7662

Weight :- 13.700kg/12'

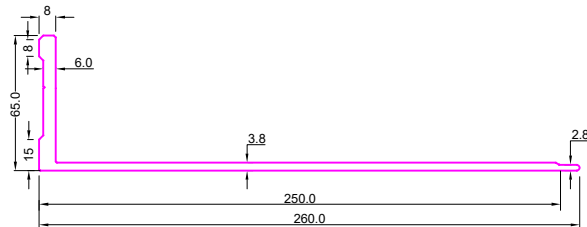

SEC. NO:- 7668

Weight :- 13.350kg/12'

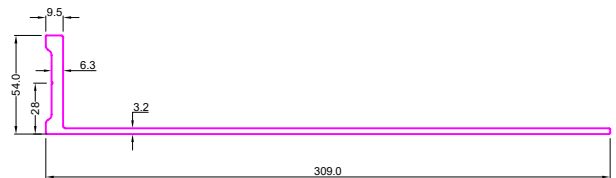



FORM WORKS

SEC. NO:- 7671

Weight :- 15.200kg/12'

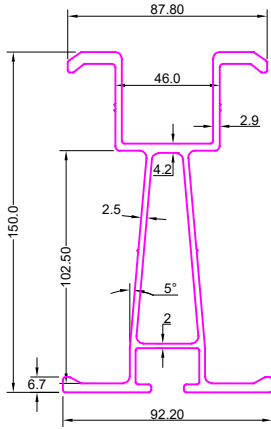

SEC. NO:- 7686

Weight :- 16.150kg/12'

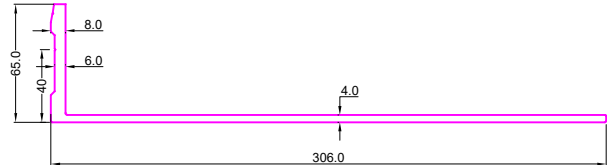

SEC. NO:- 7692

Weight :- 14.270kg/12'

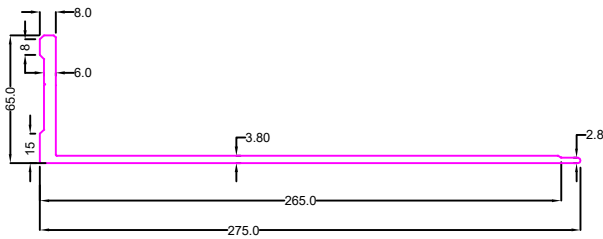

SEC No. 7694

Weight:-5.500Kg/12'

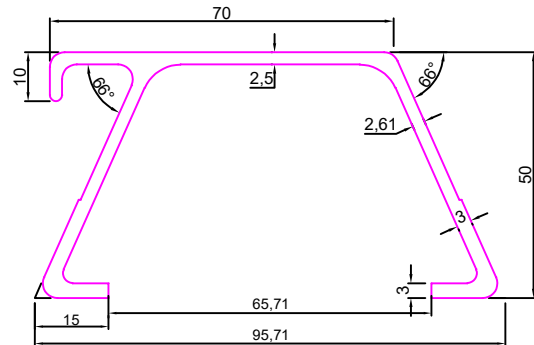

SEC No. 7695

Weight:-5.400Kg/12'

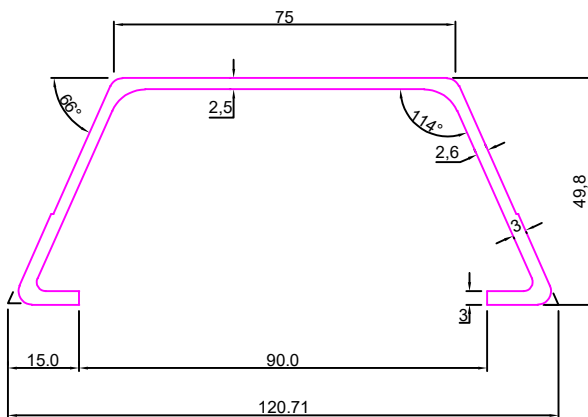

SEC No. 7710

Weight:-10.140Kg/12'

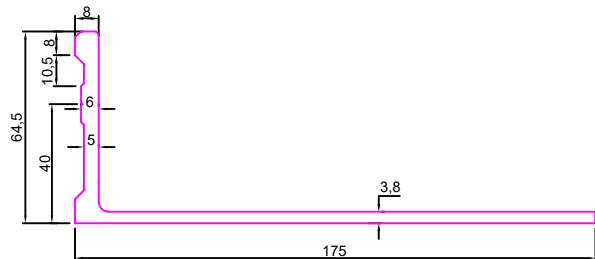



FORM WORKS

SEC No. 7711

Weight:-9.200Kg/12'

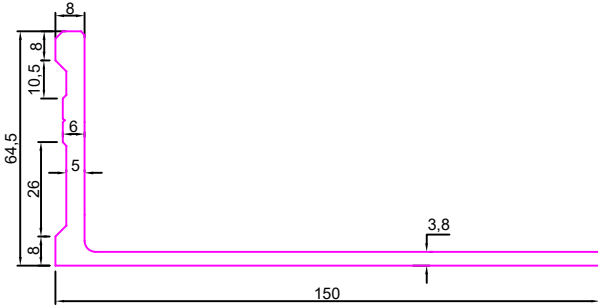

SEC No. 7712

Weight:-11.545Kg/12'

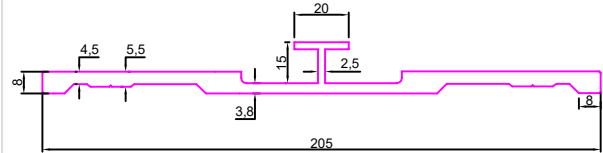

SEC No. 7713

Weight:-11.000Kg/12'

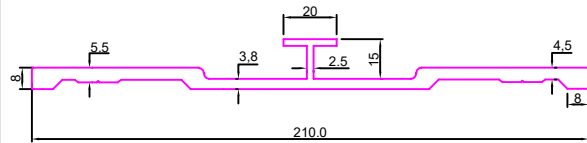

SEC No. 7714

Weight:-12.450Kg/12'

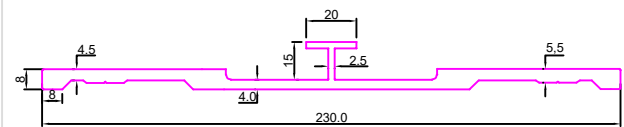

SEC No. 7715

Weight:-13.200Kg/12'

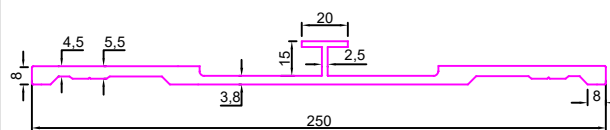

SEC No. 7716

Weight:-14.350Kg/12'

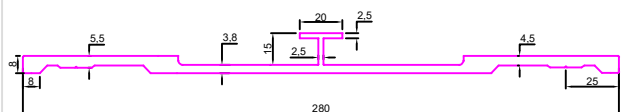



FORM WORKS

SEC No. 7717

Weight:-14.740Kg/12'

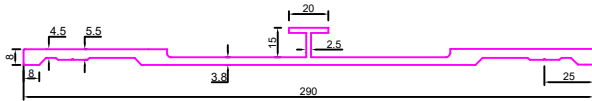

SEC No. 7718

Weight:-15.300Kg/12'

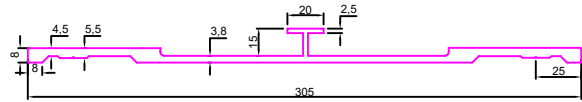

SEC No. 7719

Weight:-11.300Kg/12'

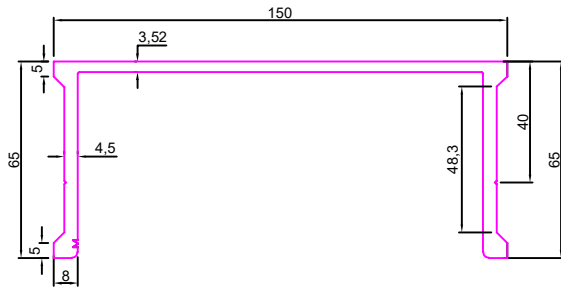

SEC No. 7720

Weight:-7.500Kg/12'

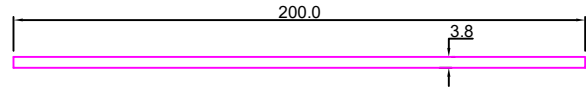

SEC No. 7721

Weight:-11.640Kg/12'

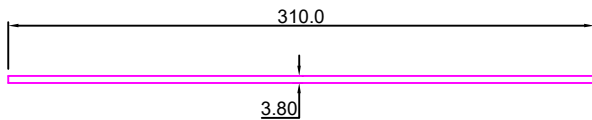

SEC No. 7725

Weight:-11.400Kg/12'

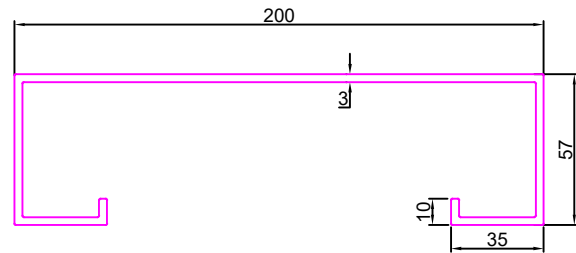



FORM WORKS

SEC No. 7726

Weight:-14.950Kg/12'

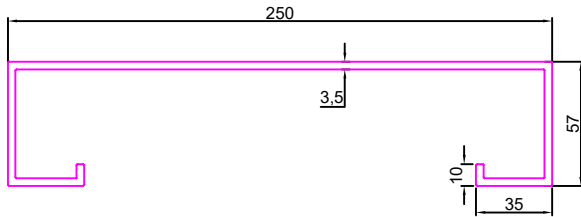

SEC No. 7727

Weight:-16.700Kg/12'

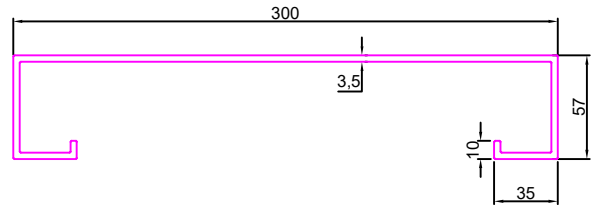

SEC No. 7732

Weight:-12.750Kg/12'

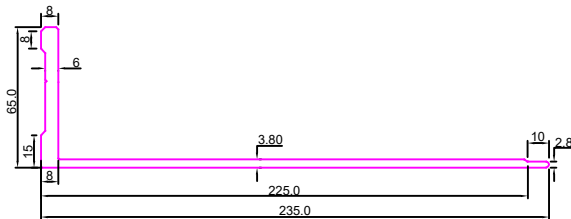

SEC No. 7741

Weight:-17.950Kg/12'

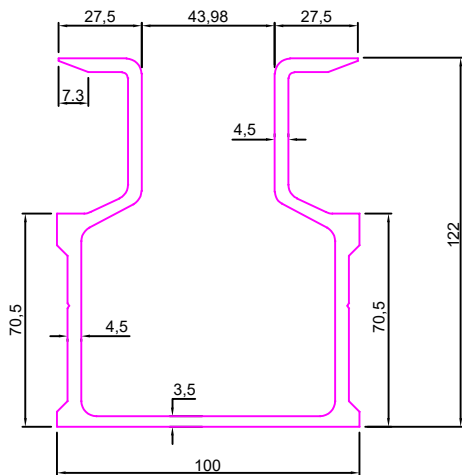

SEC No. 7742

Weight:-18.950Kg/12'

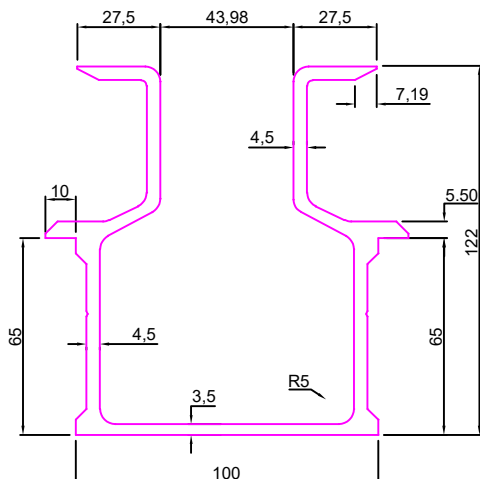

SEC No. 7748

Weight:-18.500Kg/12'

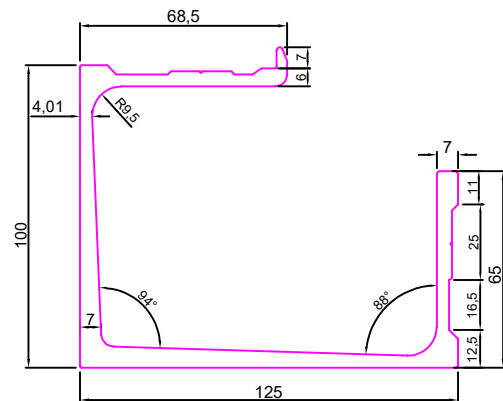



FORM WORKS

SEC No. 7749

Weight:-7.578Kg/12'

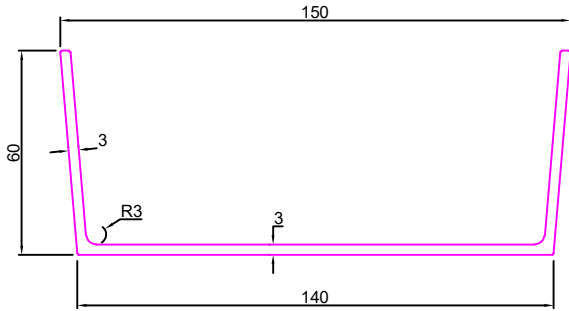

SEC No. 7750

Weight:-11.150Kg/12'

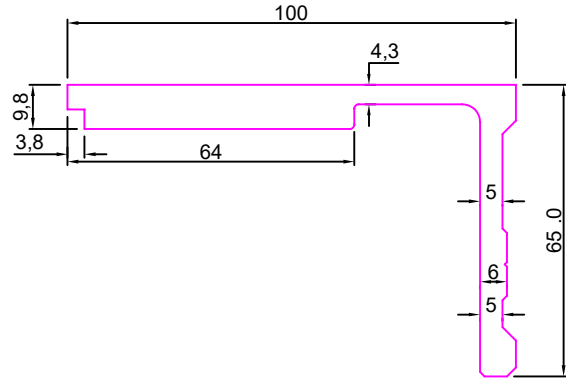

SEC No. 7773

Weight:-11.281Kg/12'

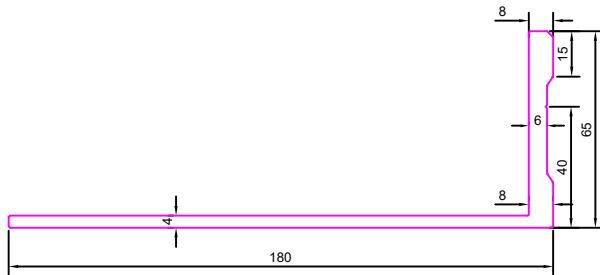

SEC No. 7774

Weight:-12.270Kg/12'

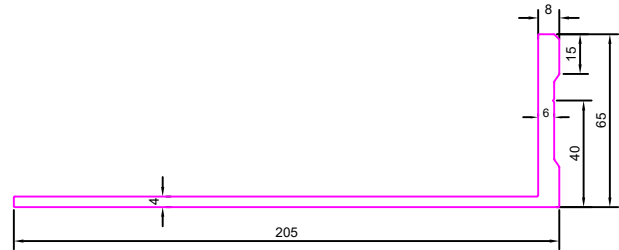

SEC No. 7775

Weight:-13.258Kg/12'

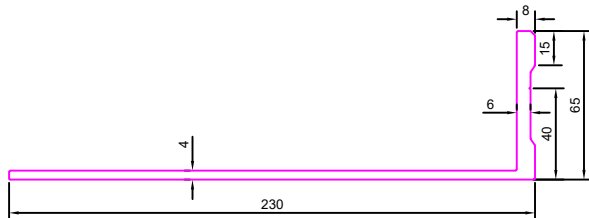

SEC No. 7776

Weight:-14.246Kg/12'





FORM WORKS

SEC No. 7777

Weight:-15.234Kg/12'

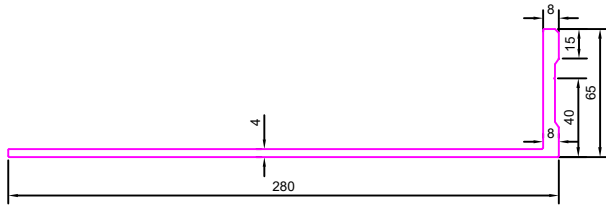

SEC No. 7778

Weight:-16.622Kg/12'

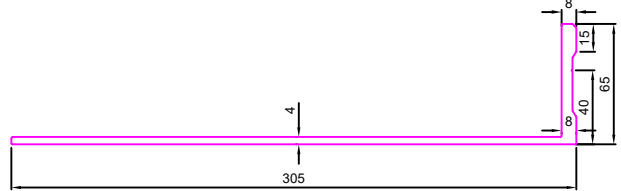

SEC No. 7784

Weight:-4.000Kg/12'

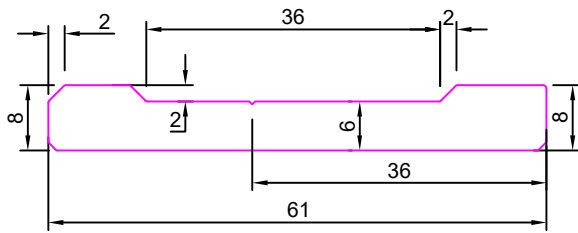

SEC No. 7822

Weight:-15.060Kg/12'

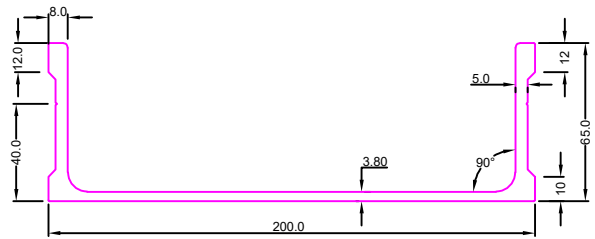

SEC No. 7823

Weight:-16.00Kg/12'

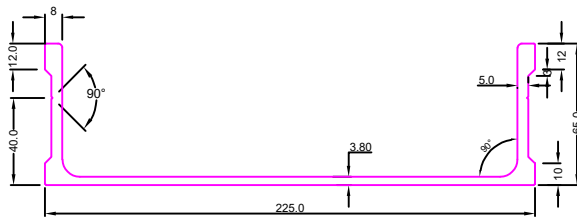

SEC No. 7824

Weight:-16.938Kg/12'

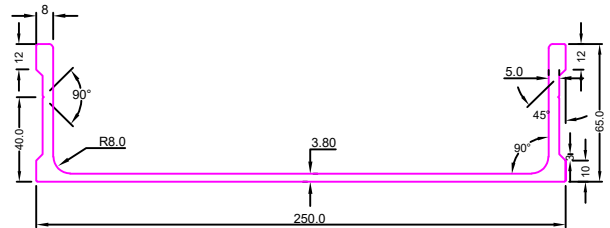



FORM WORKS

SEC No. 7825

Weight:-18.700Kg/12'

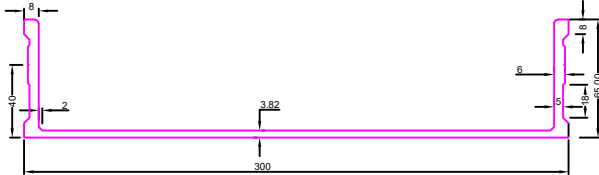

SEC No. 7826

Weight:-12.242Kg/12'

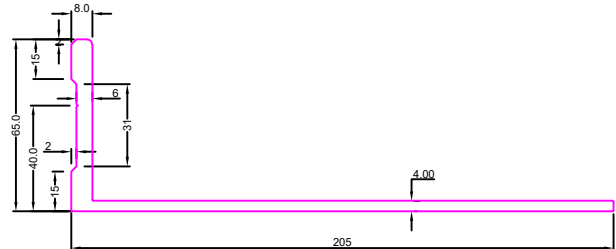

SEC No. 7827

Weight:-13.230Kg/12'

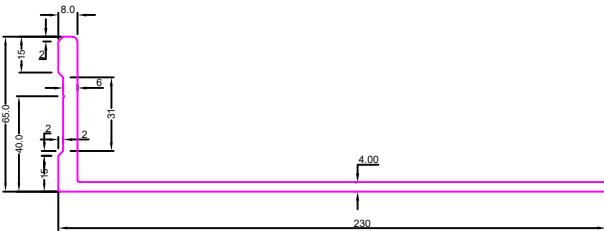

SEC No. 7828

Weight:-13.974Kg/12'

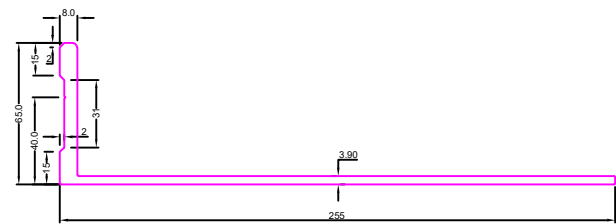

SEC No. 7829

Weight:-16.235Kg/12'

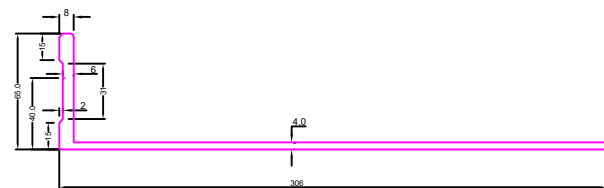

SEC No. 7832

Weight:-27.050Kg/12'

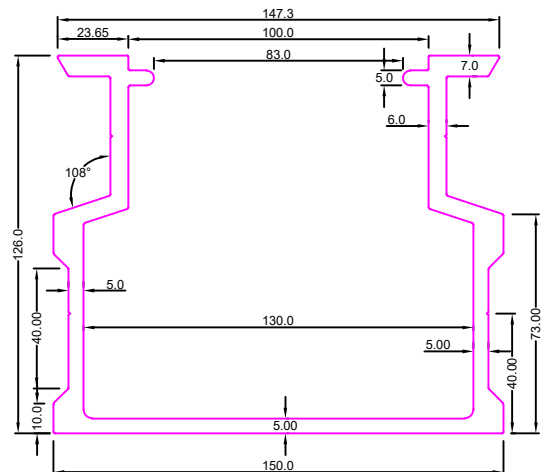



FORM WORKS

SEC No. 7833

Weight:-27.900Kg/12'

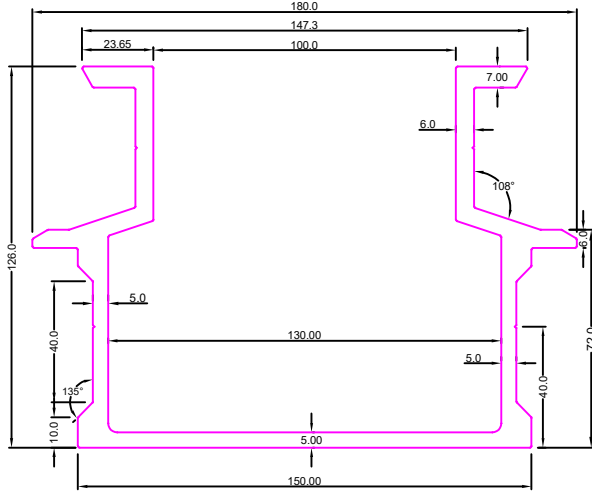

SEC No. 7834

Weight:-14.500Kg/12'

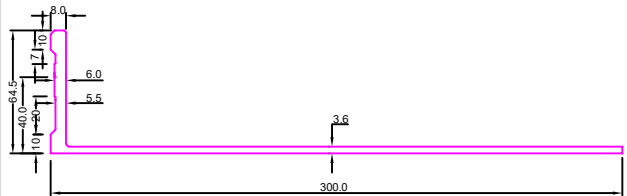

SEC No. 7840

Weight:-23.540Kg/12'

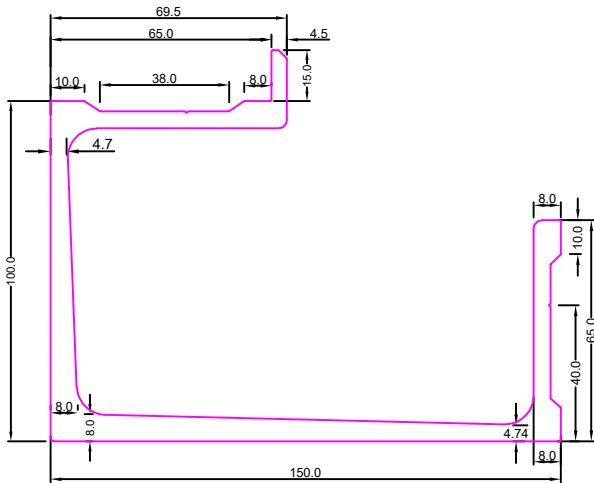

SEC No. 7841

Weight:-14.050Kg/12'

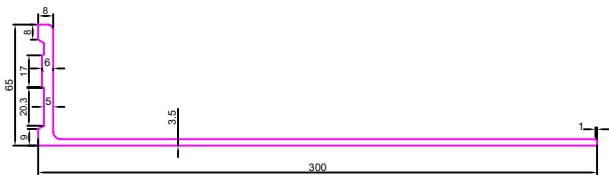

SEC No. 7852

Weight:-10.600Kg/12'

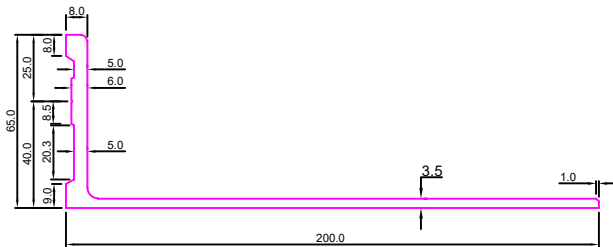

SEC No. 7853

Weight:-11.460Kg/12'

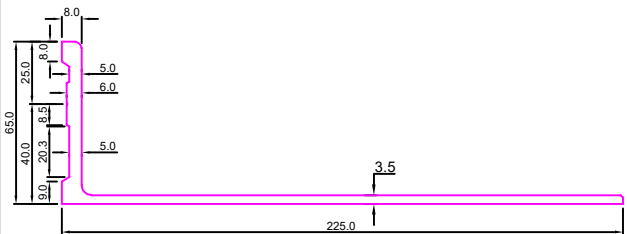



FORM WORKS

SEC No. 7878

Weight:-15.850Kg/12'

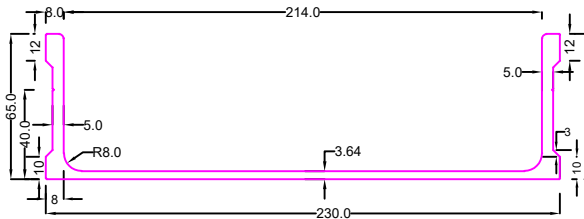

SEC No. MA7880

Weight:-13.420Kg/12'

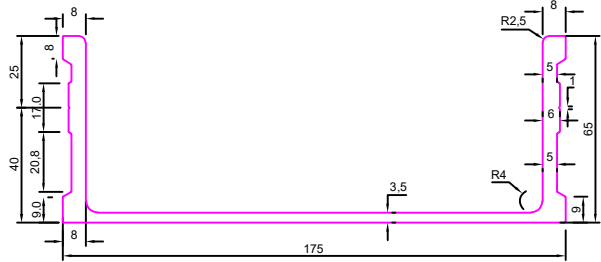

SEC No. MA7881

Weight:-23.947Kg/12'

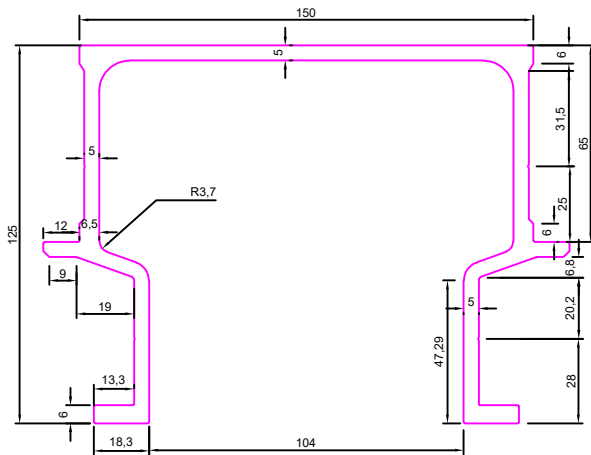

SEC No. MA7882

Weight:-22.795Kg/12'

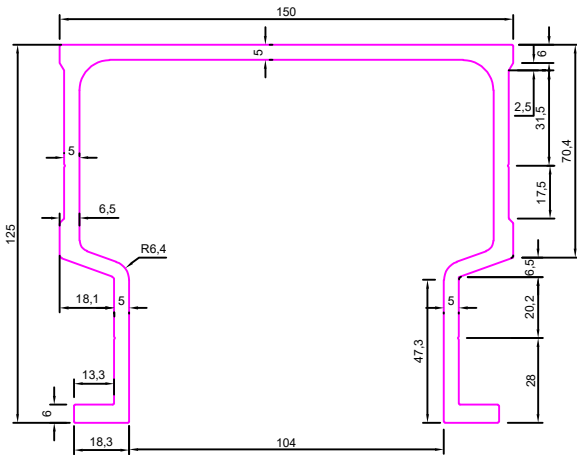

SEC No. 7883

Weight:-12.325Kg/12'

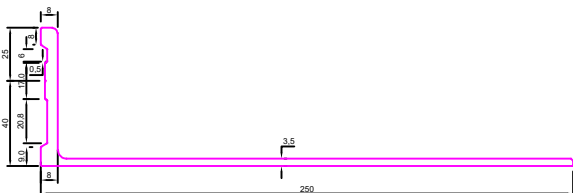

SEC No. 7884

Weight:-16.880Kg/12'

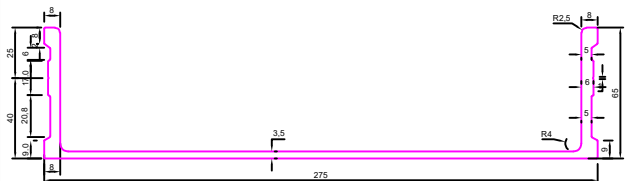



FORM WORKS

SEC No. 7887

Weight:-15.150Kg/12'

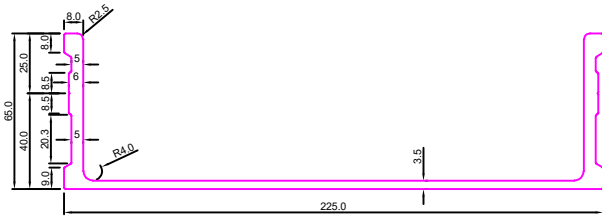

SEC No. 7893

Weight:-3.924Kg/12'

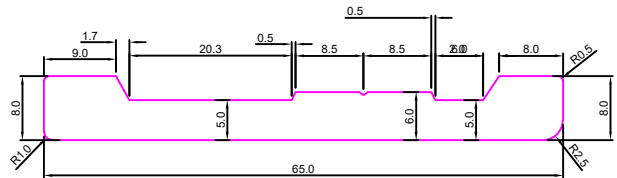

SEC No. 7894

Weight:4.253Kg/12'

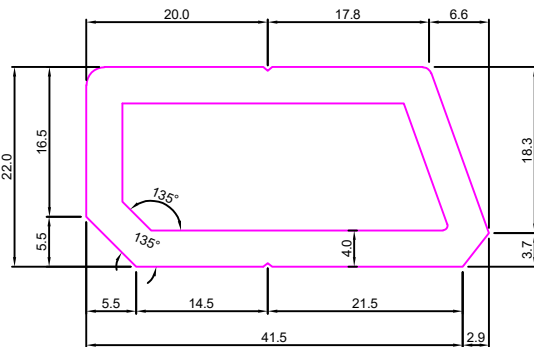

SEC No. 7895

Weight:-3.845Kg/12'

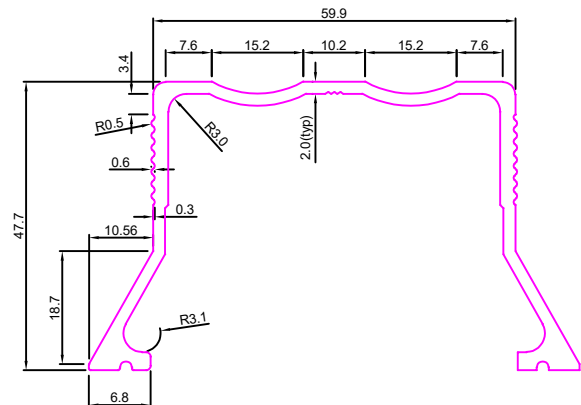



FORM WORKS

SEC No. MA7906

Weight: 16.910Kg/12'

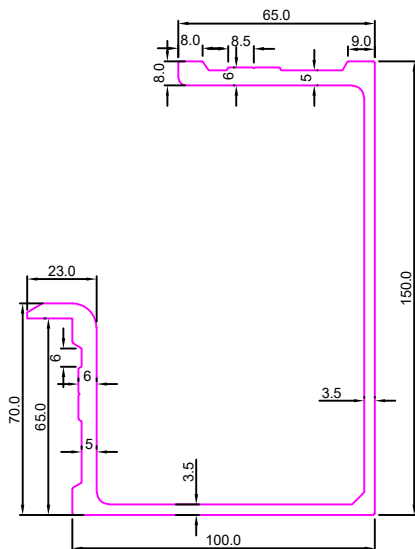

SEC No. MA7907

Weight: 12.156Kg/12'

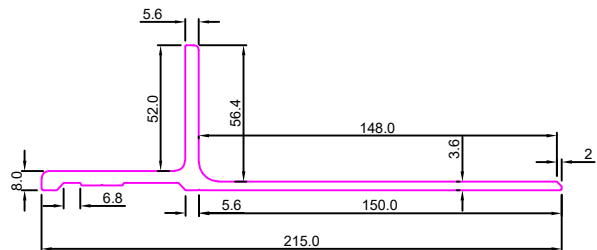



FORM WORKS

SEC No. MA7908

Weight:10.375Kg/12'

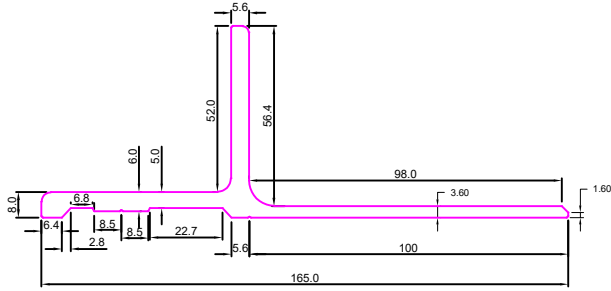

SEC No. MA7909

Weight:9.488Kg/12'

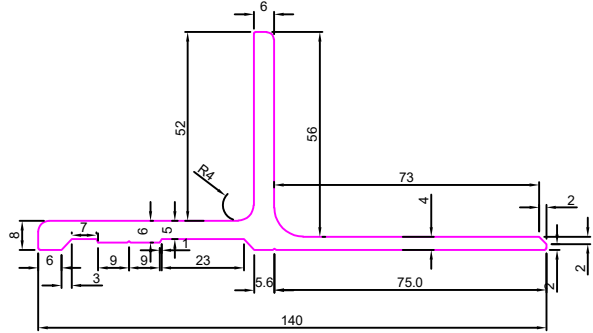

SEC No. MA7910

Weight:7.937Kg/12'

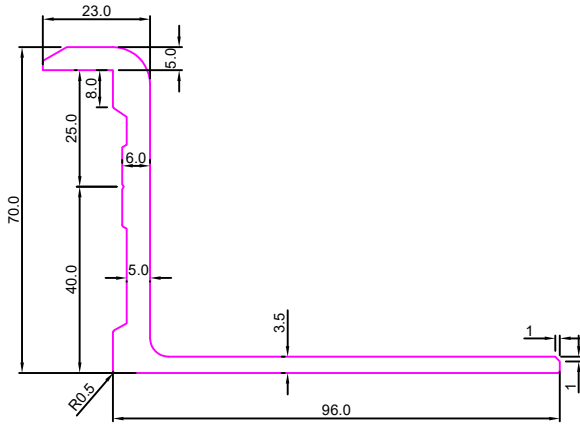

SEC No. MA7911

Weight:7.937Kg/12'

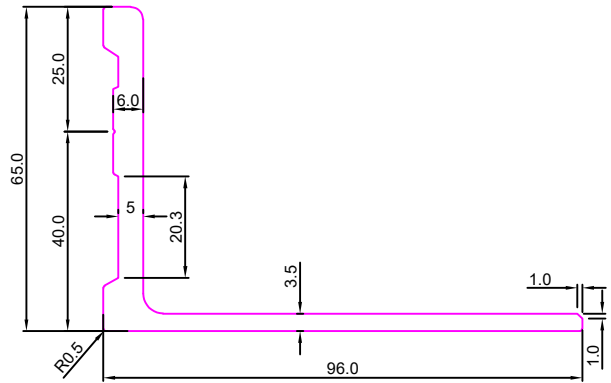

SEC No. 7915

Weight:-3.650Kg/12'

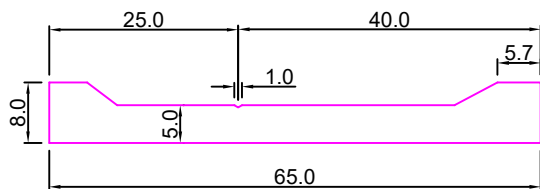

SEC No:- MA 7948

Weight:-15.840Kg/12'

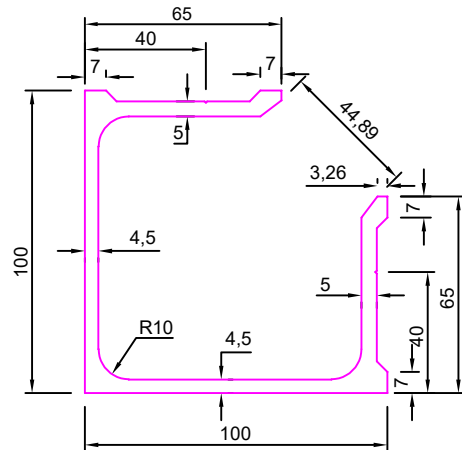



FORM WORKS

SEC No:- MA7956

Weight:-15.180Kg/12'

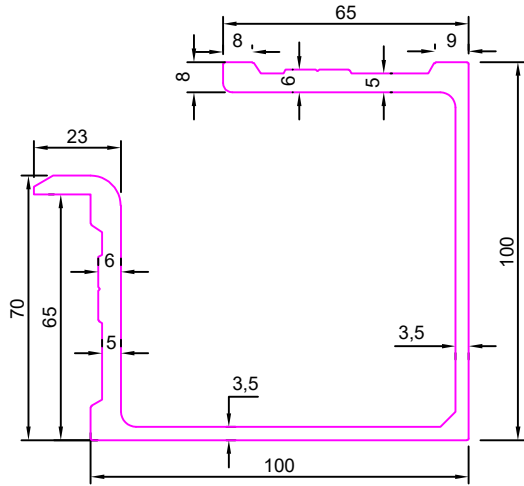

SEC No. GA7971

Weight:-15.234Kg/12'

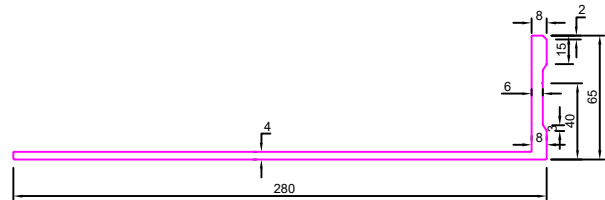

SEC No. GA7972

Weight:-14.246Kg/12'

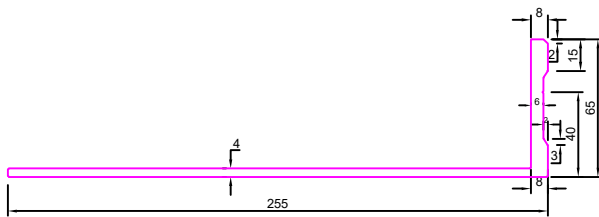

SEC No. GA7973

Weight:-13.974Kg/12'

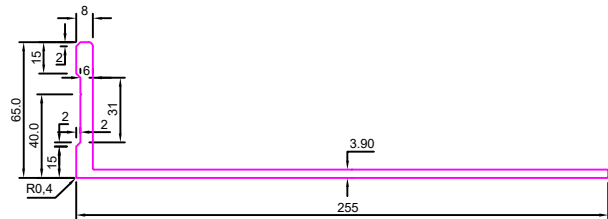

SEC No. GA7974

Weight:-13.258Kg/12'

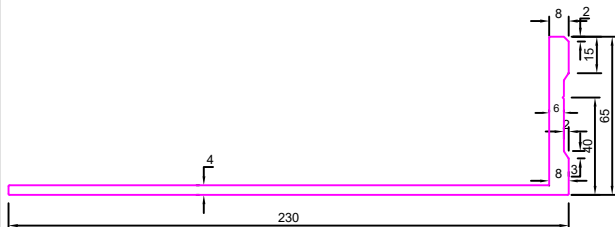

SEC No. GA7975

Weight:-13.230Kg/12'

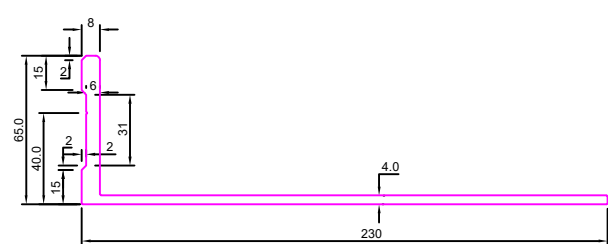



FORM WORKS

SEC No. MA7984

Weight:-16.565Kg/12'

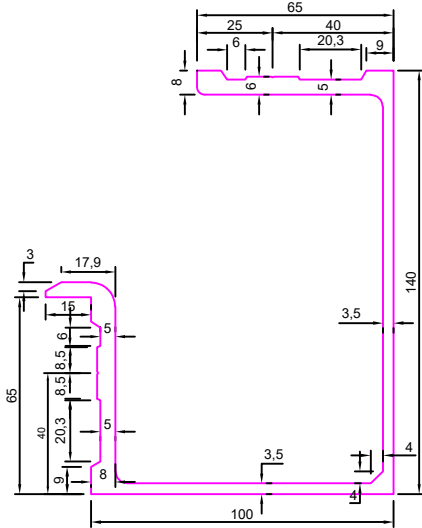

SEC No. MA7985

Weight:-6.375Kg/12'

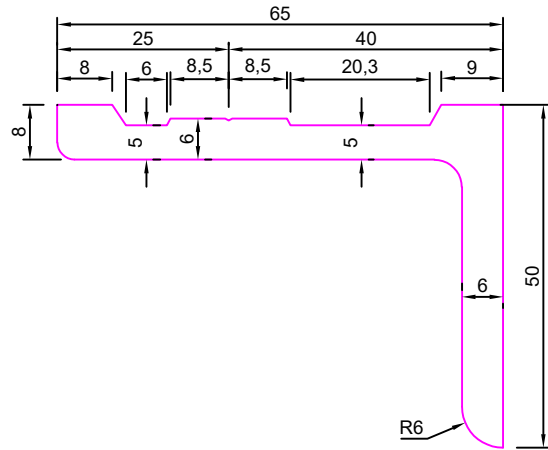

SEC No. MA7986

Weight:-9.760Kg/12'

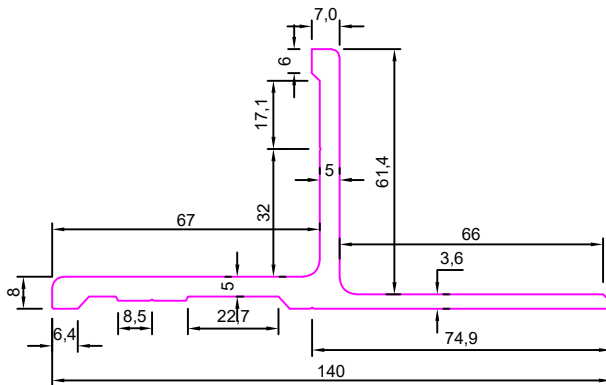

SEC No. MA7987

Weight:-10.650Kg/12'

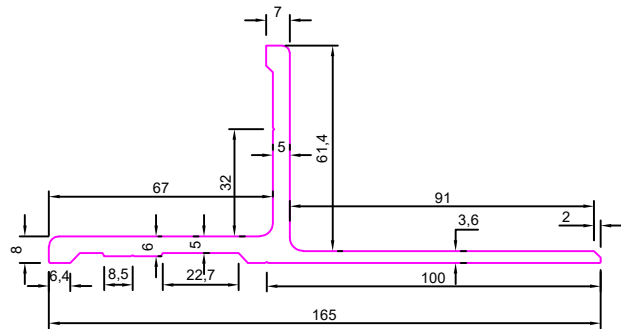

SEC No. MA7988

Weight:-12.429Kg/12'

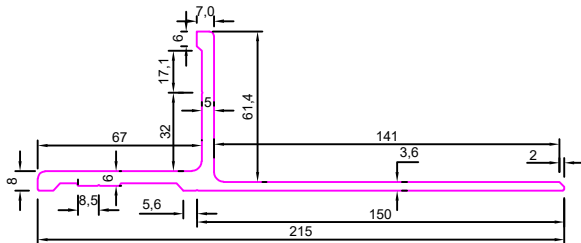

SEC No. MA7989

Weight:-17.785Kg/12'

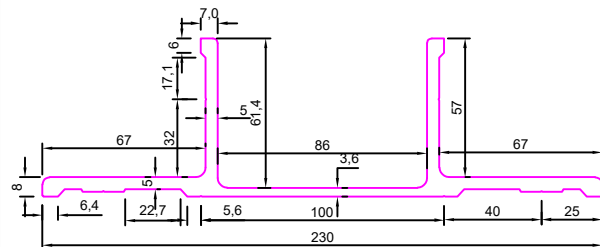



FORM WORKS

SEC No. VA8020

Weight:-4.000Kg/12'

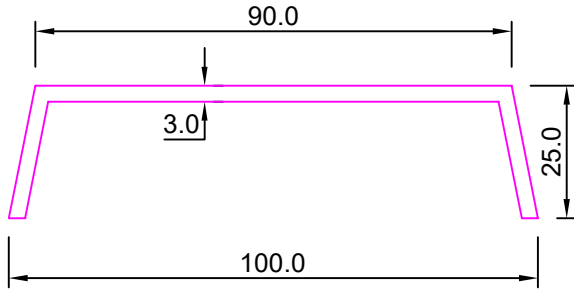

SEC No. VA8021

Weight:-3.600Kg/12'

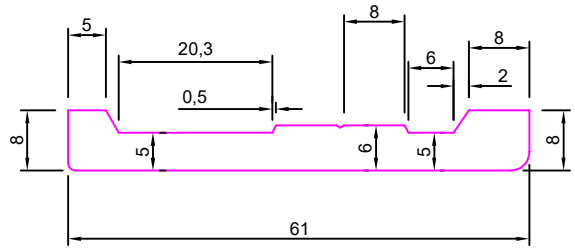

SEC No. VA8022

Weight:-1.000Kg/12'

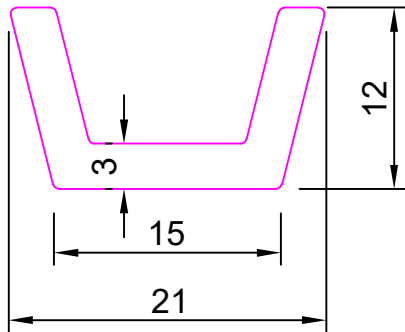

SEC No. VA8023

Weight:-2.800Kg/12'

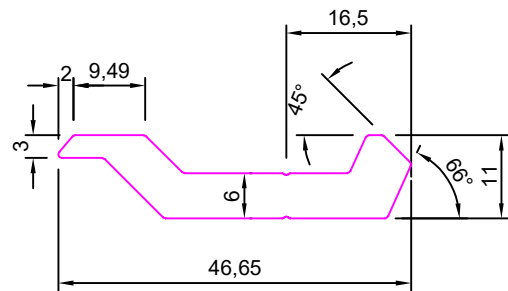

SEC No. VA8024

Weight:-1.690Kg/12'

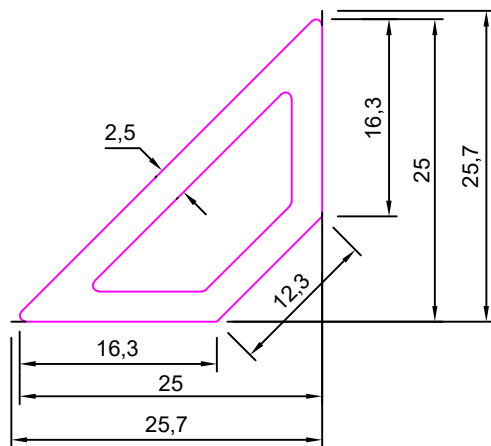

SEC No. 8031

Weight:-3.050Kg/12'

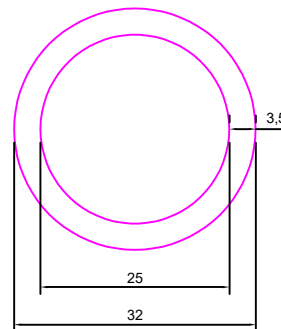



FORM WORKS

SEC No. VA8032

Weight:-5.250Kg/12'

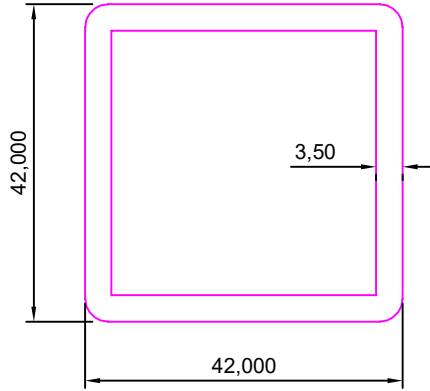

SEC No. GA8033

Weight:-11.300Kg/12'

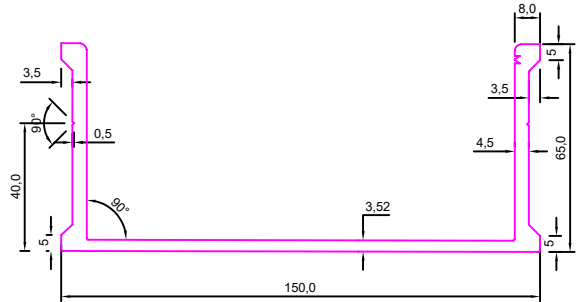

SEC No. GA8034

Weight:-12.200Kg/12'

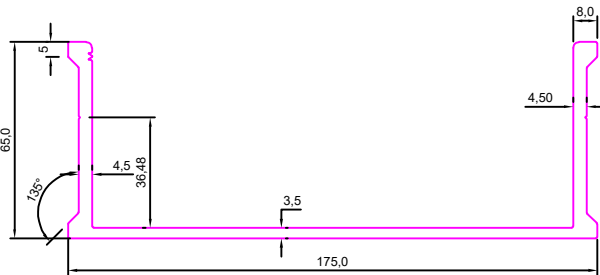

SEC No. GA8035

Weight:-16.000Kg/12'

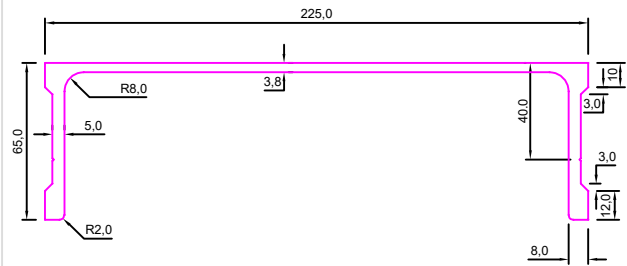

SEC No. MA8036

Weight:-8.480Kg/12'

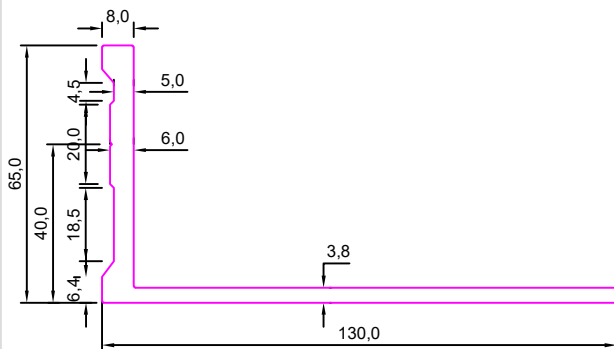

SEC No. MA8037

Weight:-11.870Kg/12'

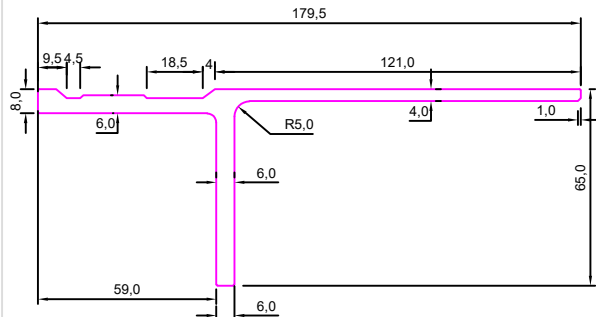



FORM WORKS

SEC No. MA8038

Weight:-13.890Kg/12'

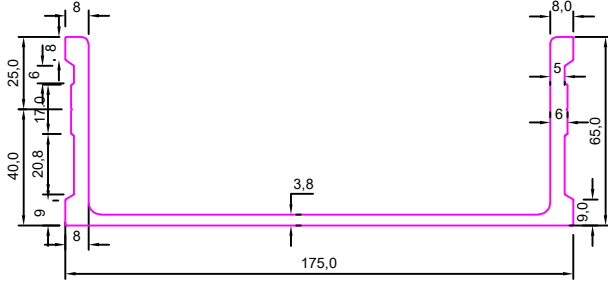

SEC No. MA8039

Weight:-16.185Kg/12'

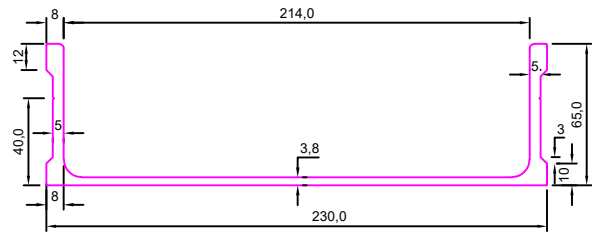

SEC No. GA8049

Weight:-3.385Kg/12'

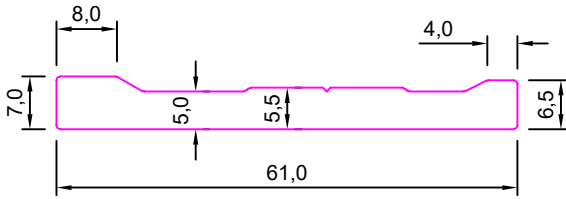

SEC No. SA8050

Weight:-14.935Kg/12'

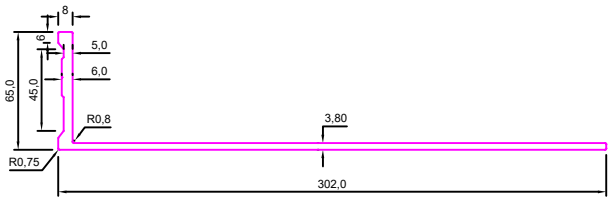

SEC No. SA8051

Weight:-16.290Kg/12'

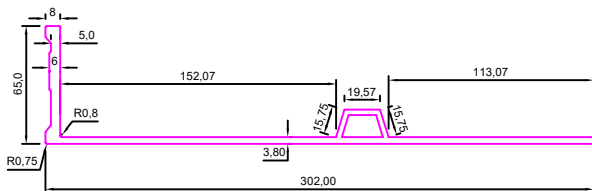

SEC No. VA8052

Weight:-11.500Kg/12'

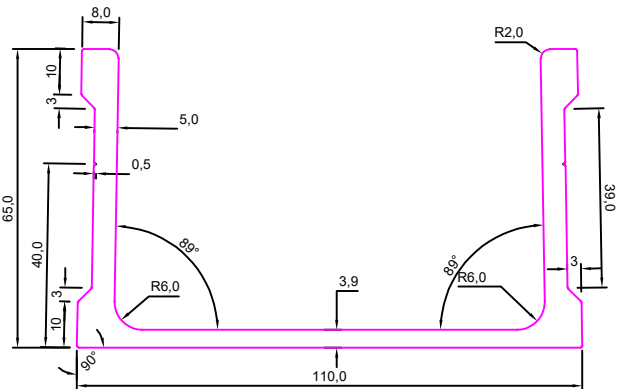



FORM WORKS

SEC No. GA8053

Weight:-16.545Kg/12'

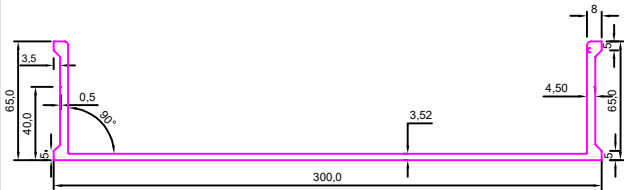

SEC No. 8054

Weight:-3.420Kg/12'

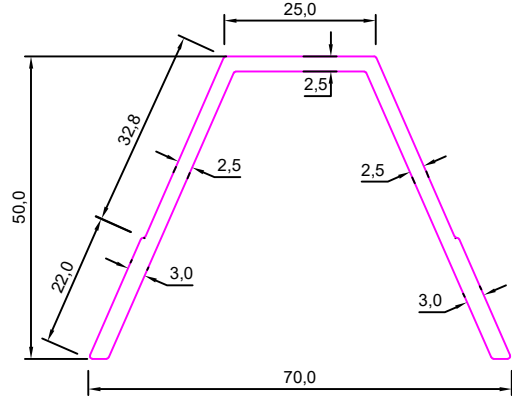

SEC No. 8055

Weight:-6.140Kg/12'

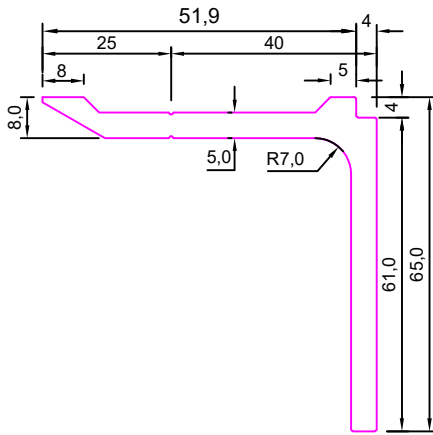

SEC No. 8056

Weight:-4.220Kg/12'

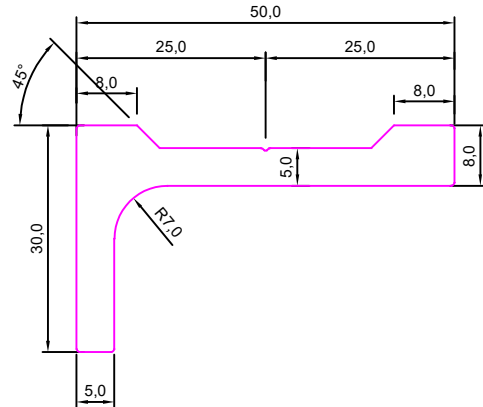

SEC No. 8060

Weight:-11.155Kg/12'

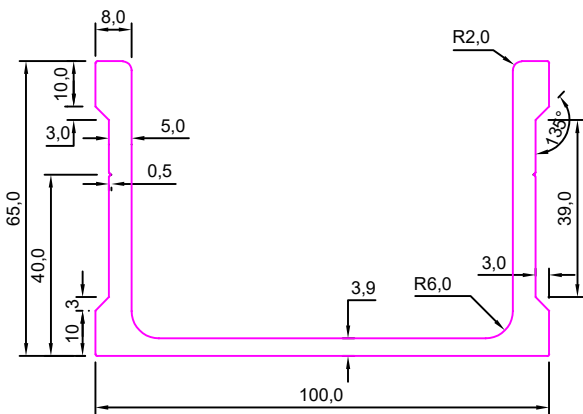

SEC No. 8061

Weight:-12.115Kg/12'

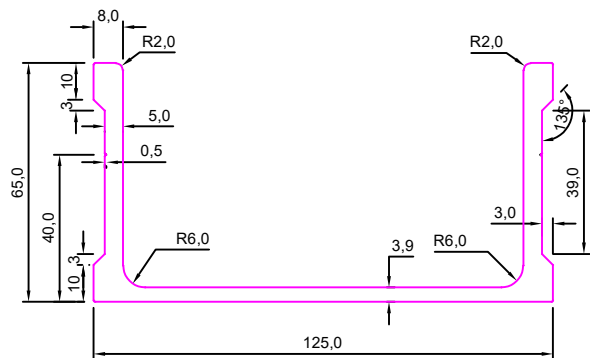



FORM WORKS

SEC No. GA8063

Weight:-15.675Kg/12'

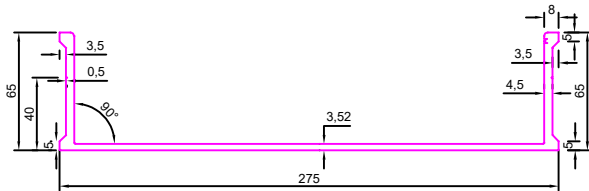

SEC No. 8074

Weight:-2.200Kg/12'

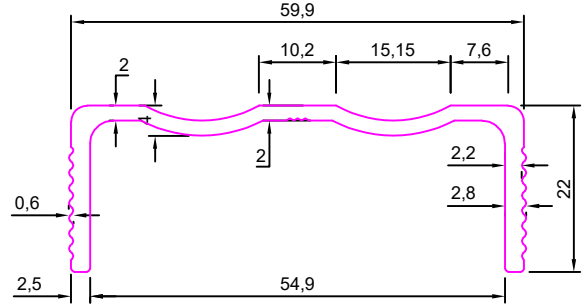

SEC No. VA8075

Weight:-3.400Kg/12'

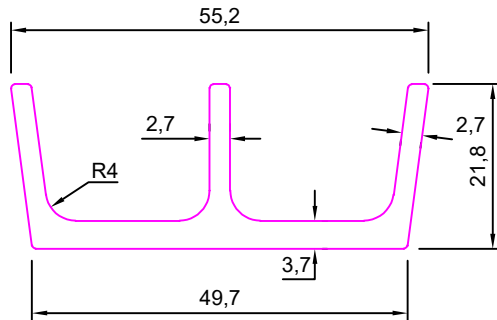

SEC No:- GA8103

Weight:-21.450Kg/12'

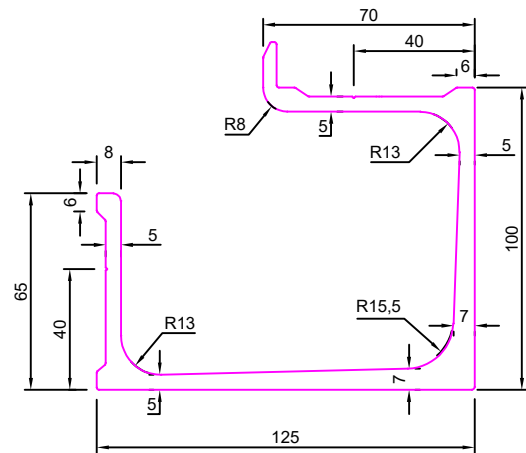

SEC No:- GA8104

Weight:-18.450Kg/12'

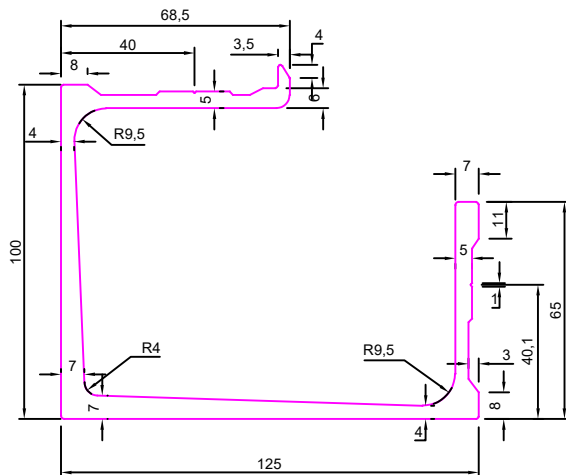

SEC No:- 8114

Weight:-4.000Kg/12'

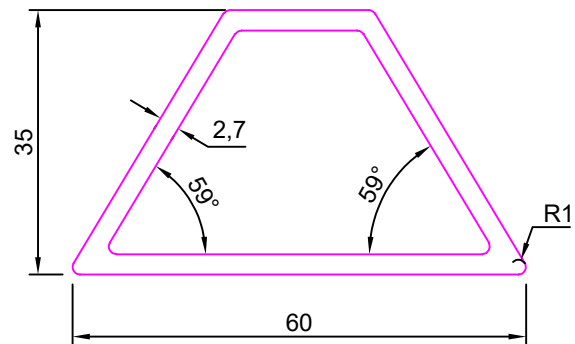



FORM WORKS

SEC No. 8144

Weight:-4.655Kg/12'

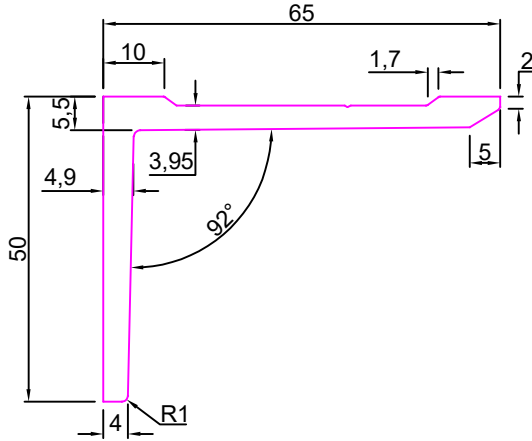

SEC No. 8145

Weight:-2.915Kg/12'

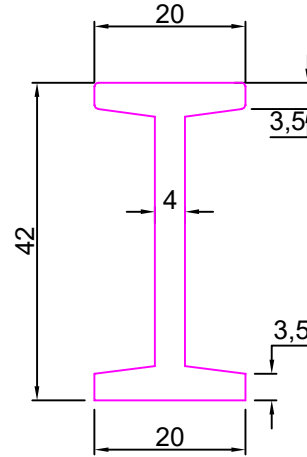

SEC No. SA8154

Weight:-11.225Kg/12'

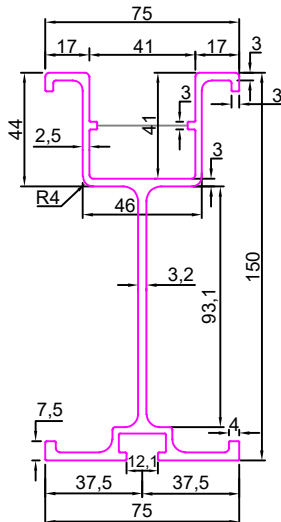

SEC No:- VA8158

Weight:-1.250Kg/12'

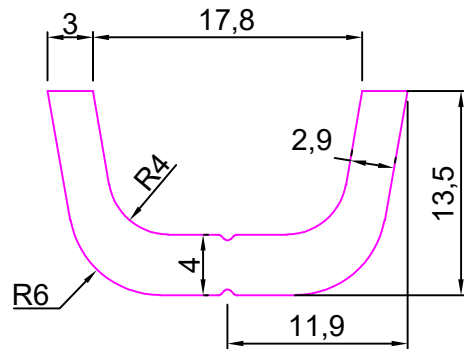

SEC No:-VA8173

Weight:16.500Kg/12'

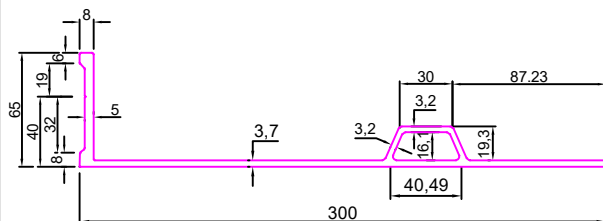

SEC No:-VA8174

Weight:20.550Kg/12'

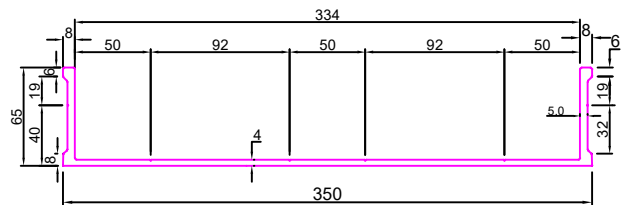



FORM WORKS

SEC No:-VA8175

Weight:22.540Kg/12'

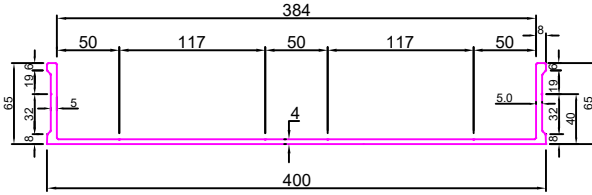

SEC No:-VA8176

Weight:24.510Kg/12'

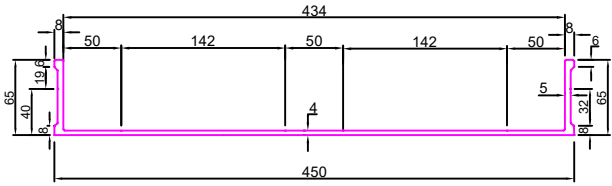

SEC No:-8177

Weight:7.200Kg/12'

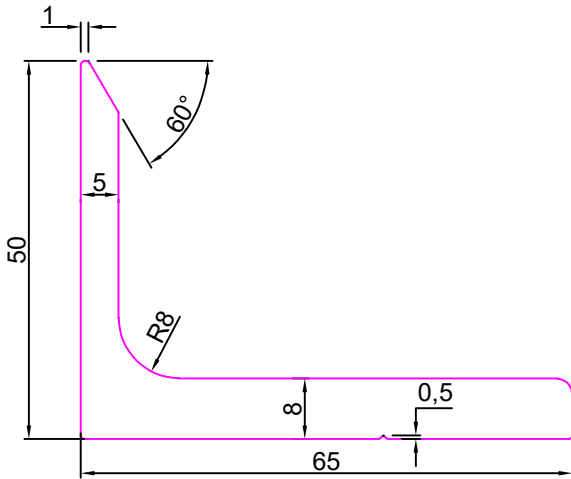

SEC No:-8178

Weight:5.000Kg/12'

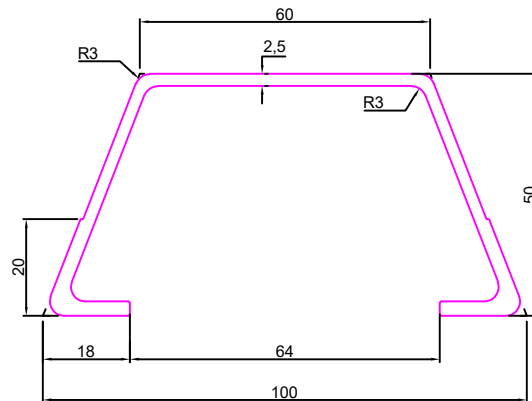

SEC No:-VA8179

Weight:14.185Kg/12'

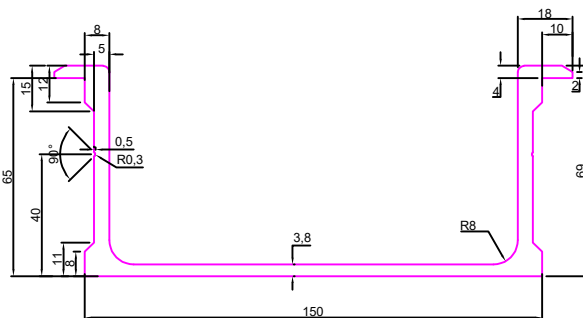

SEC No:-8180

Weight:9.285Kg/12'

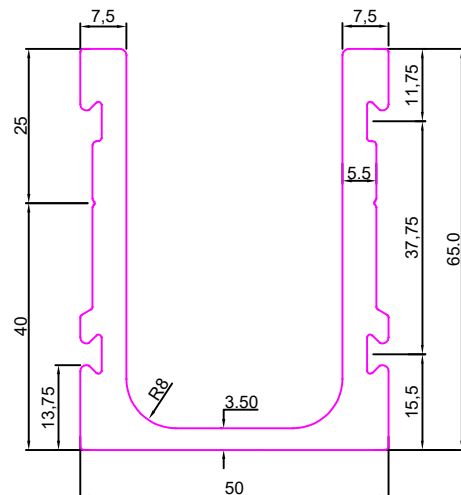



FORM WORKS

SEC No:-8181

Weight:9.630Kg/12'

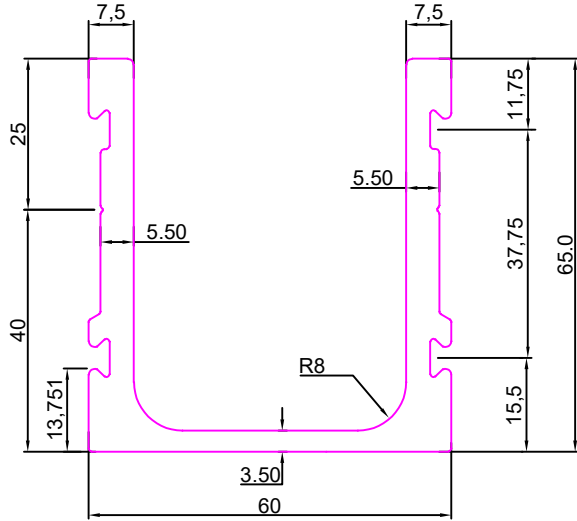

SEC No:-8182

Weight:10.150Kg/12'

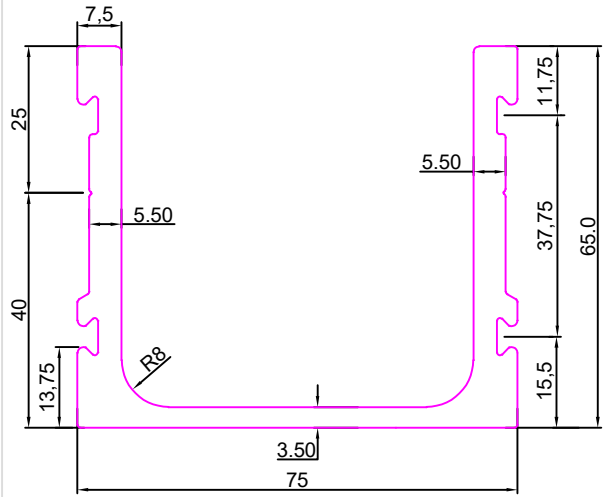

SEC No:-8183

Weight:10.840Kg/12'

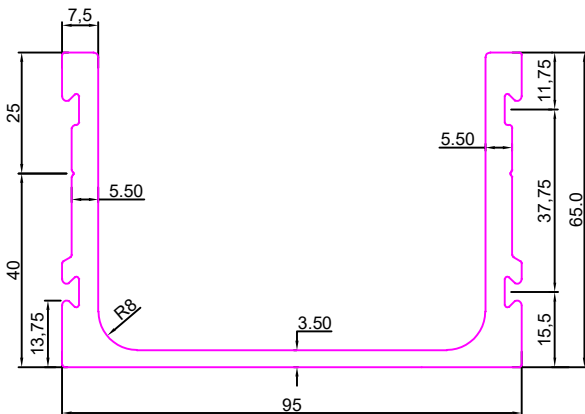

SEC No:-8184

Weight:11.000Kg/12'

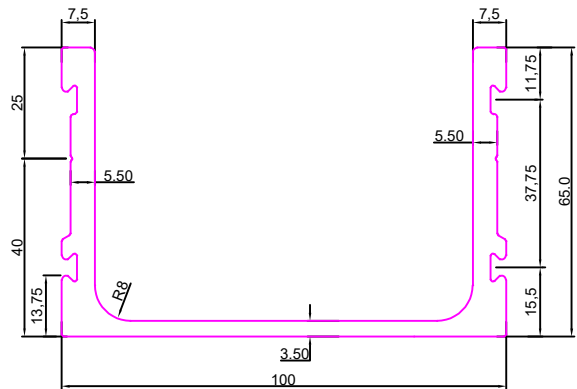

SEC No:-8185

Weight:11.880Kg/12'

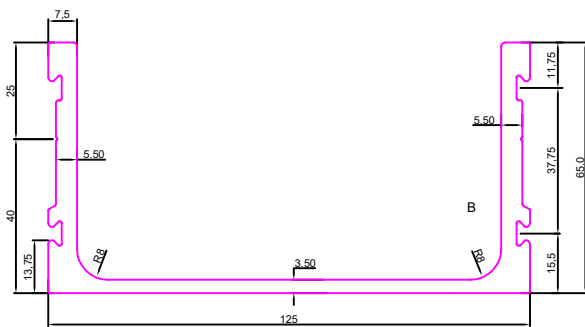

SEC No:-SA8186

Weight:12.740Kg/12'

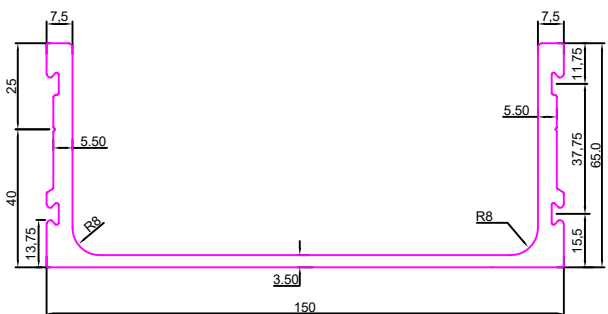



FORM WORKS

SEC No:-SA8187

Weight:13.925Kg/12'

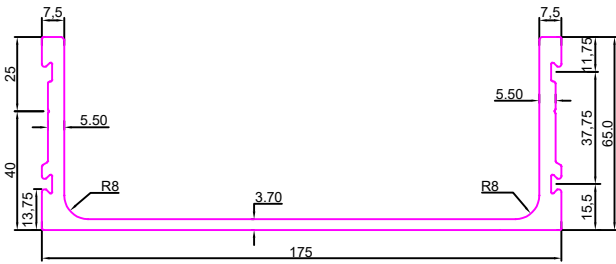

SEC No:-SA8188

Weight:14.840Kg/12'

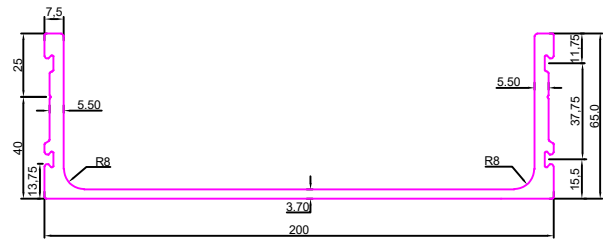

SEC No:-SA8189

Weight:11.000Kg/12'

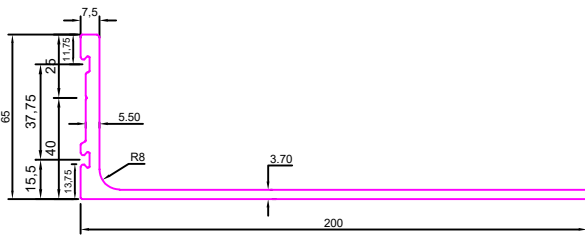

SEC No:-SA8190

Weight:14.315Kg/12'

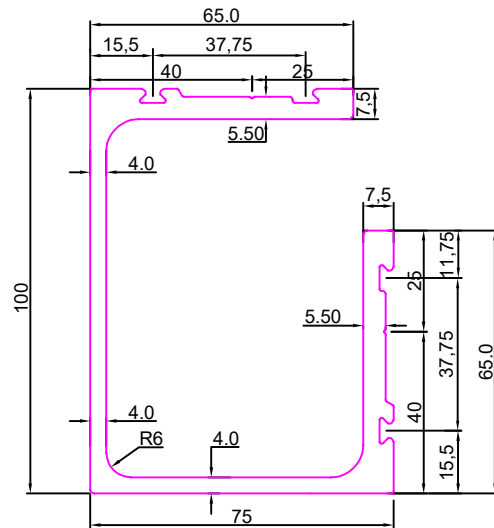

SEC No:-SA8191

Weight:15.300Kg/12'

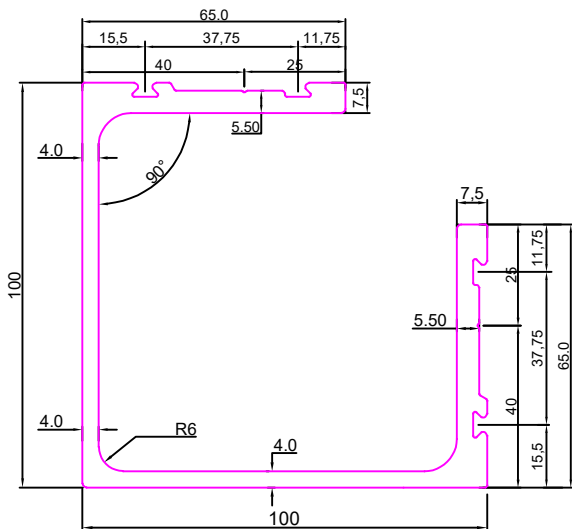

SEC No. 8200

Weight:-17.700Kg/12'

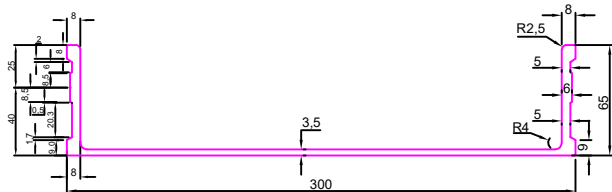



FORM WORKS

SEC No. :-8230

Weight:-19.275Kg/12'

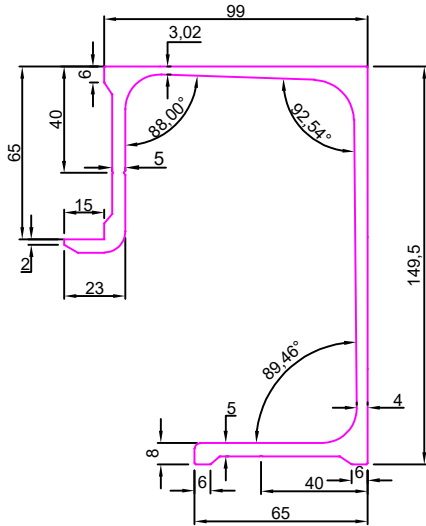

SEC No. :-8237

Weight:-6.00Kg/12'

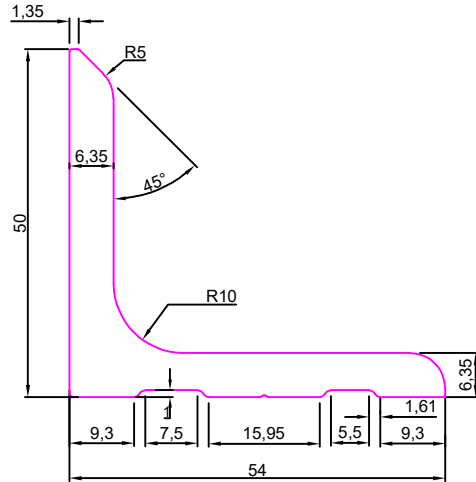

SEC No. :-8238

Weight:-18.900Kg/12'

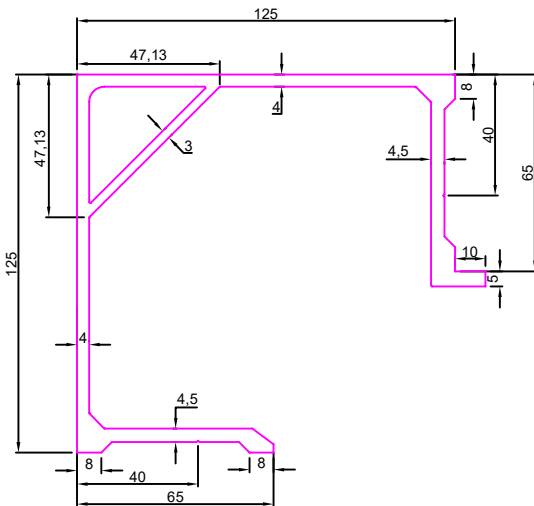

SEC No. :-8239

Weight:-17.730Kg/12'

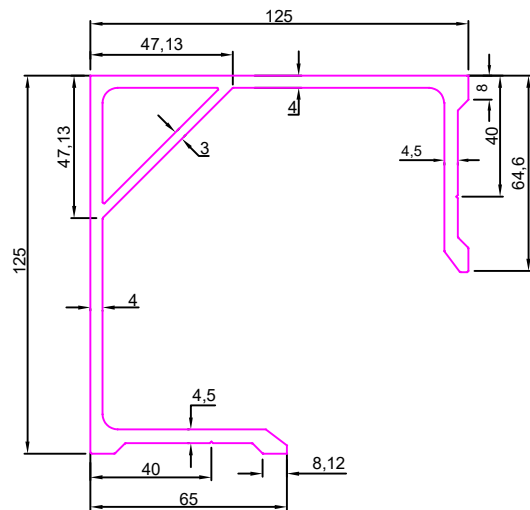

SEC No. :-8240

Weight:-7.740Kg/12'

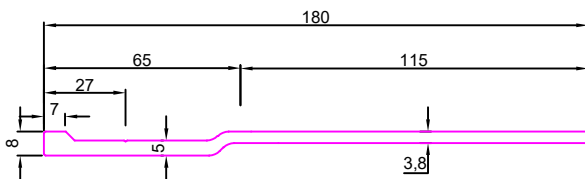

SEC No. :-8241

Weight:-22.850Kg/12'

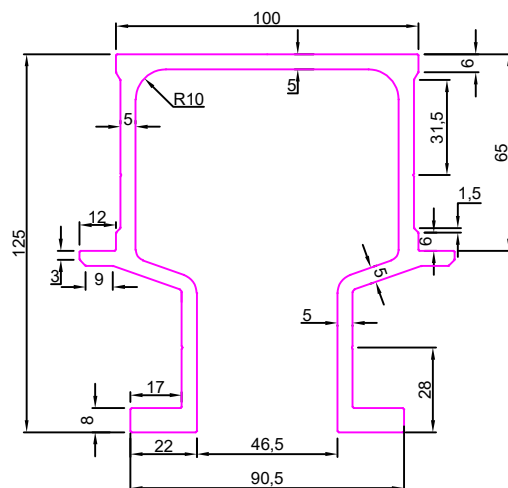



FORM WORKS

SEC No. :-8242

Weight:-15.650Kg/12'

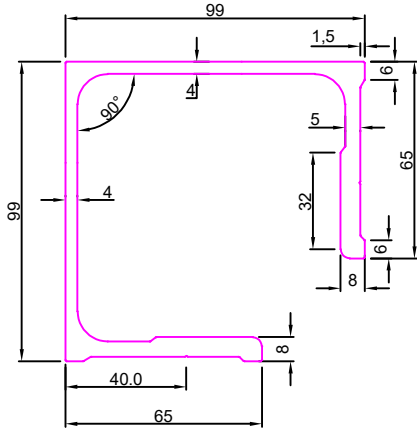

SEC No. :-8243

Weight:-20.100Kg/12'

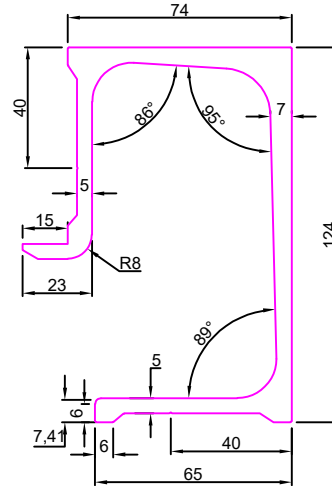

SEC No. :-8244

Weight:-18.150Kg/12'

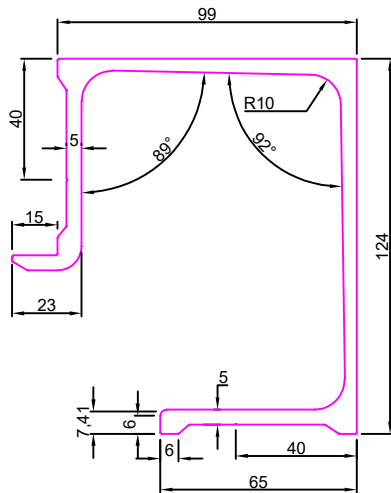

SEC No. :-8245

Weight:-19.300Kg/12'

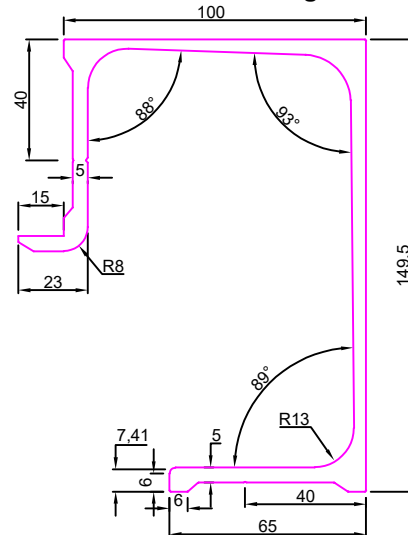

SEC No. :-MA8250

Weight:-20.355Kg/12'

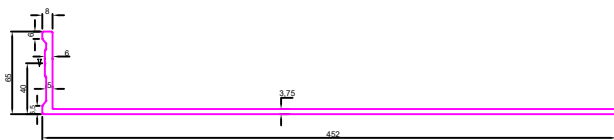

SEC No. :-8252

Weight:-4.350Kg/12'

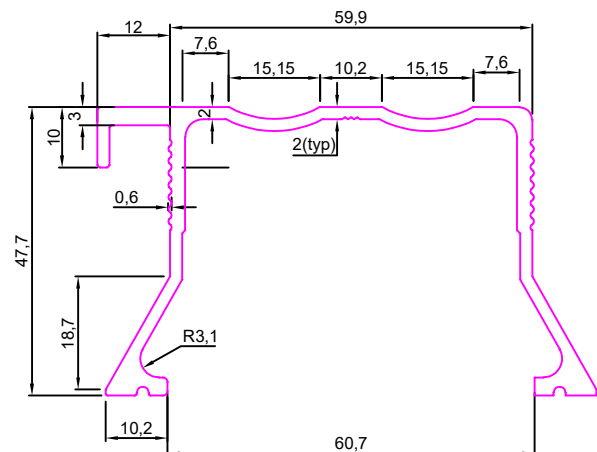



FORM WORKS

SEC No. :-VA8253

Weight:-19.650Kg/12'

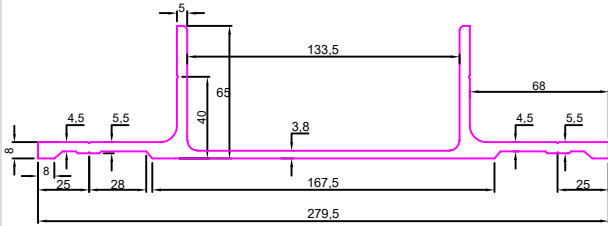

SEC No. :-VA8254

Weight:-21.550Kg/12'

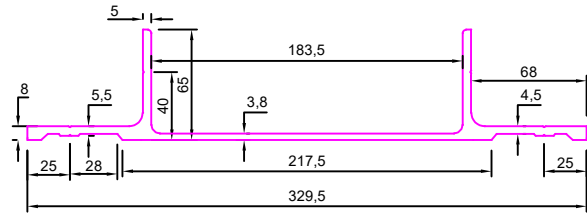

SEC No. :-VA8255

Weight:-20.675Kg/12'

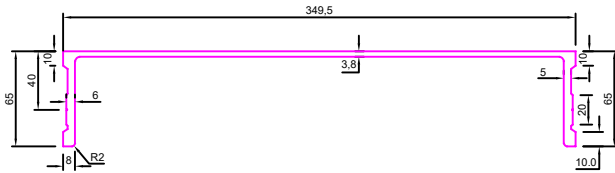

SEC No. :-VA8256

Weight:-22.555Kg/12'

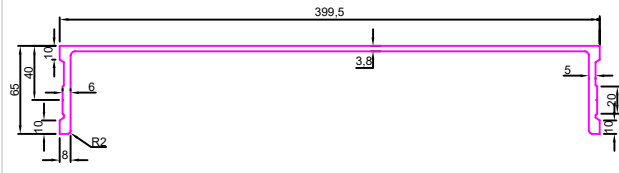

SEC No. :-8257

Weight:-24.430Kg/12'

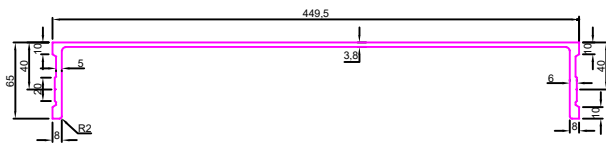

SEC No. :-8258

Weight:-10.875Kg/12'

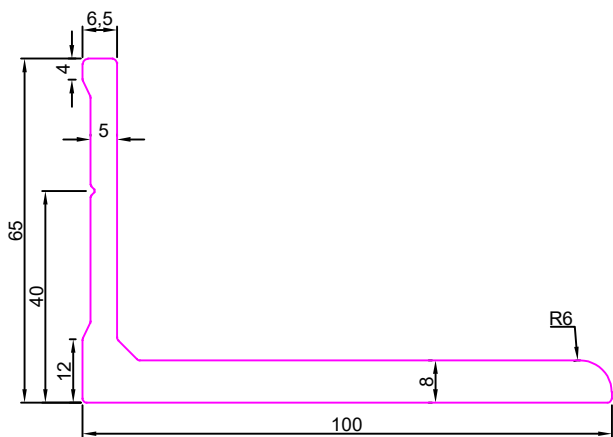



FORM WORKS

SEC No. :-8259

Weight:-13.100Kg/12'

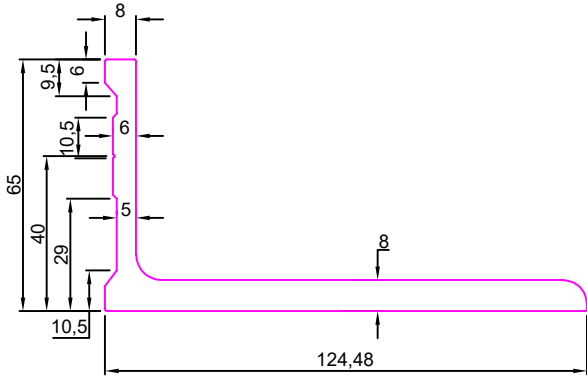

SEC No. :-8260

Weight:-11.600Kg/12'

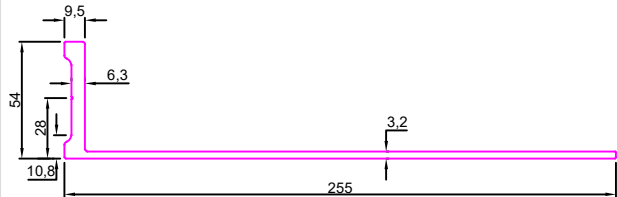

SEC No. :-8261

Weight:-10.950Kg/12'

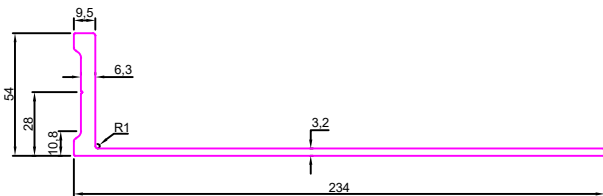

SEC No. :-8263

Weight:-10.967Kg/12'

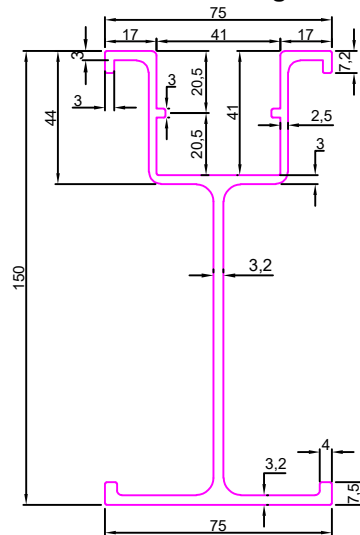

SEC No. :-8266

Weight:-3.687Kg/12'

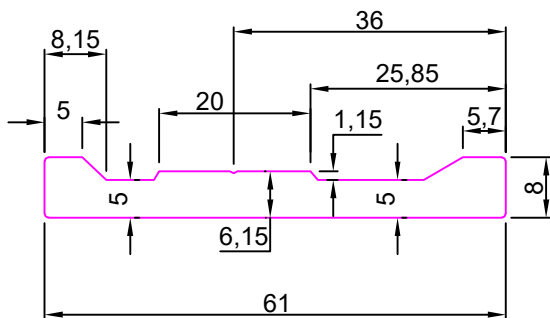

SEC No. :-8267

Weight:-3.687Kg/12'

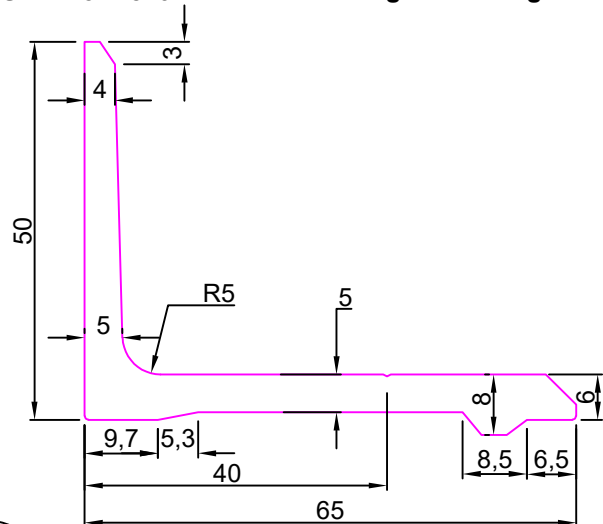



FORM WORKS

SEC No. :-8268

Weight:-3.379Kg/12'

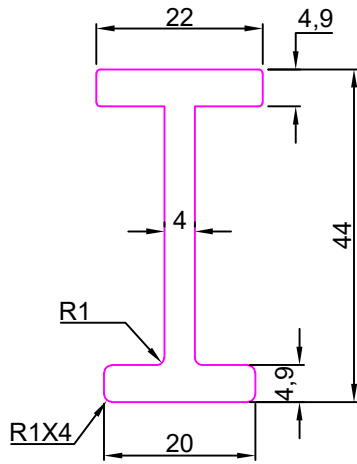

SEC No. :-8269

Weight:-3.662Kg/12'

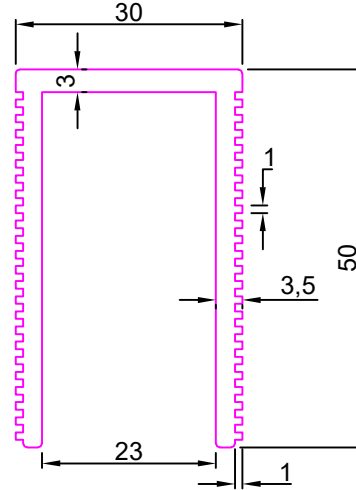

SEC No. :-8270

Weight:-6.700Kg/12'

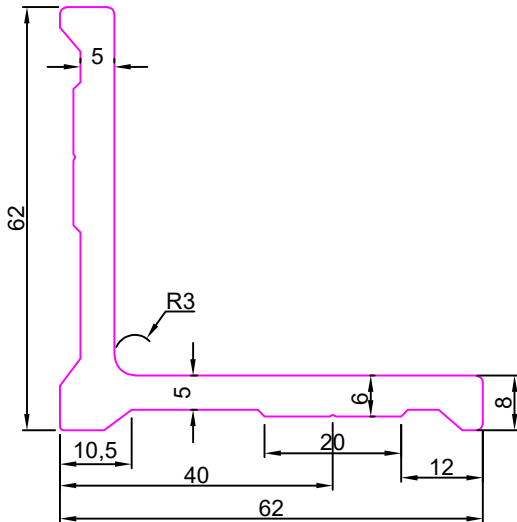

SEC No. :-MA8271

Weight:-15.635Kg/12'

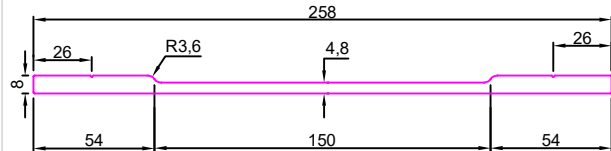

SEC No. 8293

Weight:-7.000Kg/12'

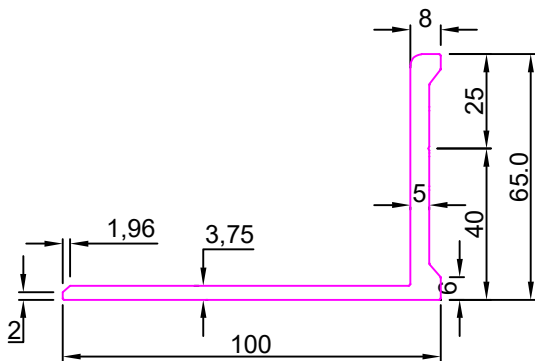

SEC No. 8294

Weight:-15.190Kg/12'

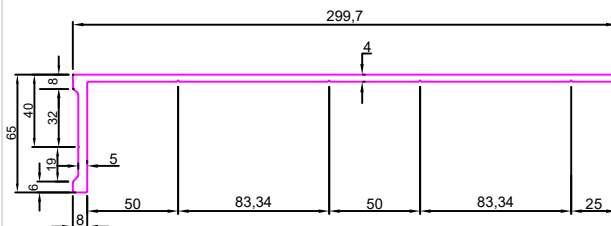



FORM WORKS

SEC No. 8299

Weight:-3.590Kg/12'

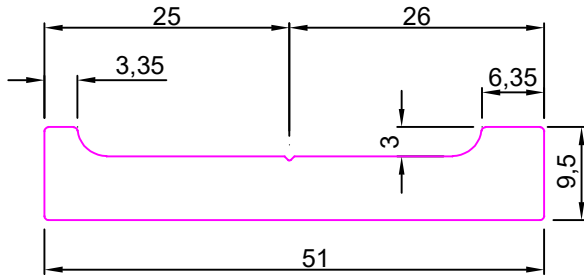

SEC No. 8300

Weight:-4.225Kg/12'

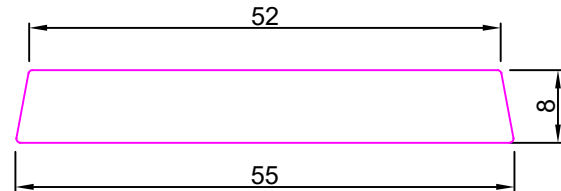

SEC No. 8305

Weight:-25.380Kg/12'

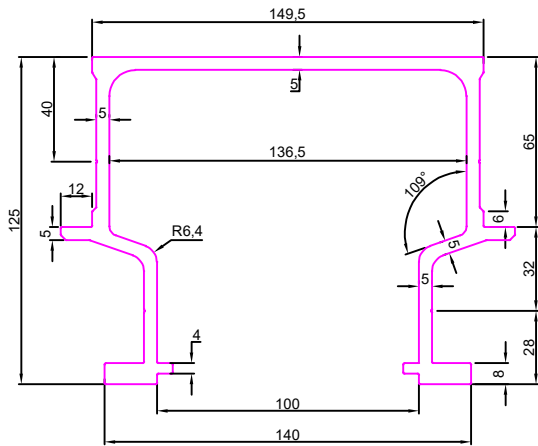

SEC No. 8324

Weight:-2.950Kg/12'

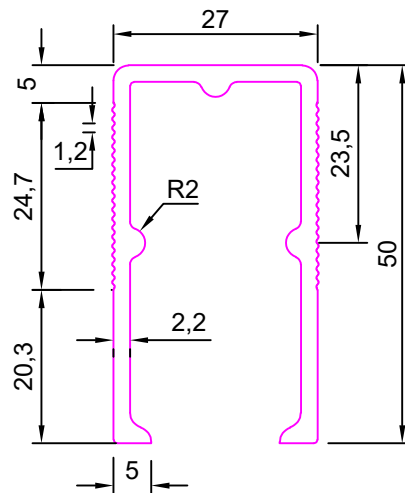

SEC No. 8330

Weight:-16.700Kg/12'

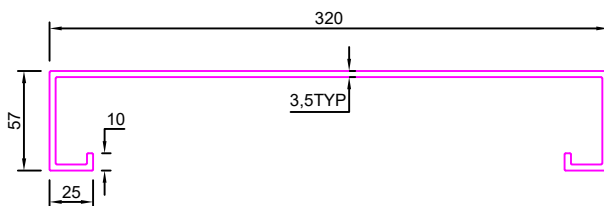

SEC No. 8331

Weight:-13.790Kg/12'

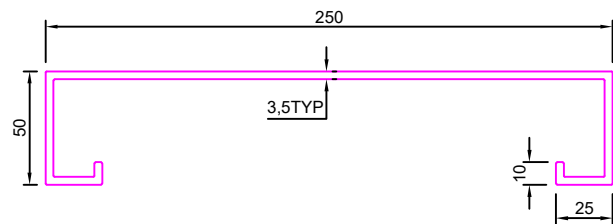



FORM WORKS

SEC No. 8332

Weight:-10.550Kg/12'

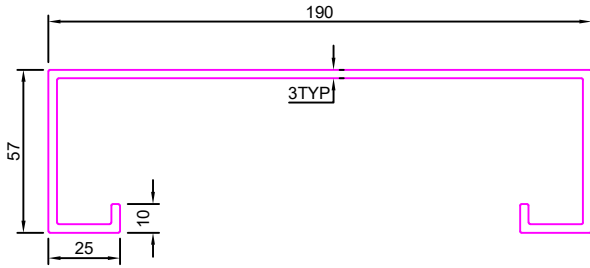

SEC No. 8335

Weight:-11.100Kg/12'

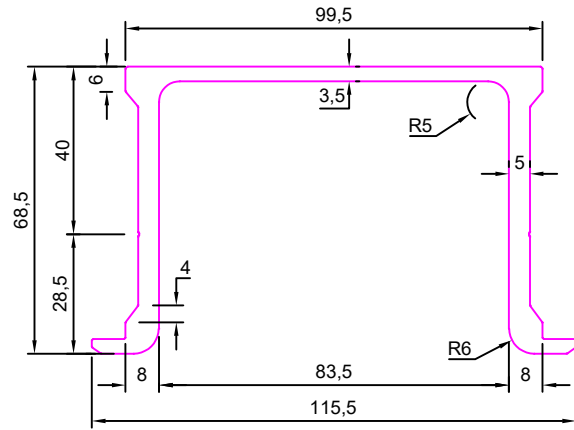

SEC No. 8364

Weight:-9.600Kg/12'

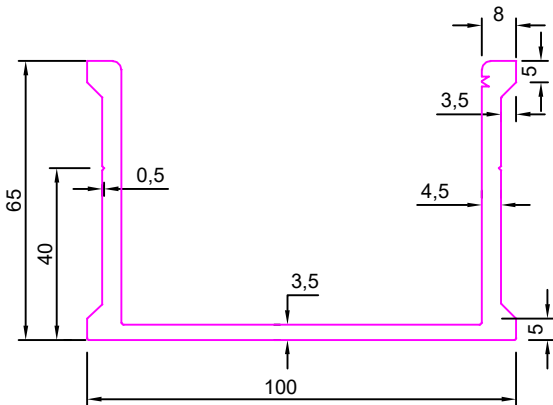

SEC No. 8365

Weight:-10.450Kg/12'

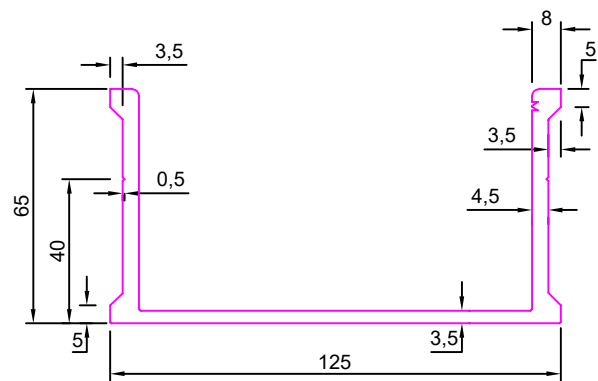

SEC No. 8367

Weight:-21.900Kg/12'

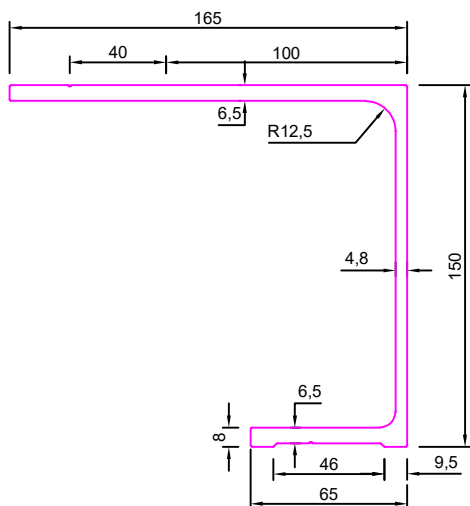

SEC No. 8368

Weight:-8.250Kg/12'

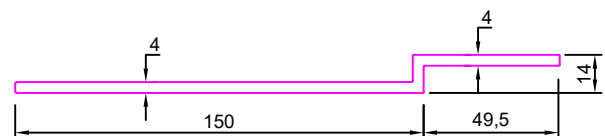



FORM WORKS

SEC No. 8394

Weight:-4.900Kg/12'

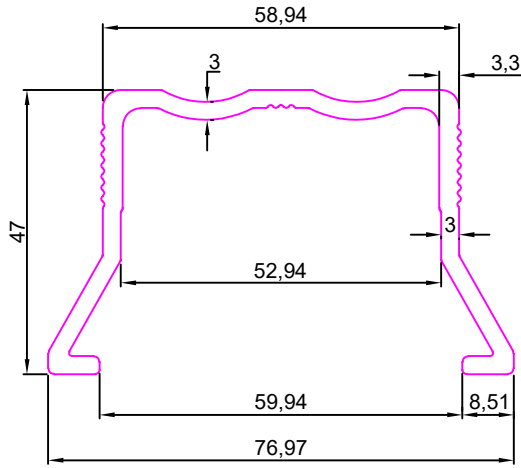

SEC No. 8395

Weight:-3.340Kg/12'

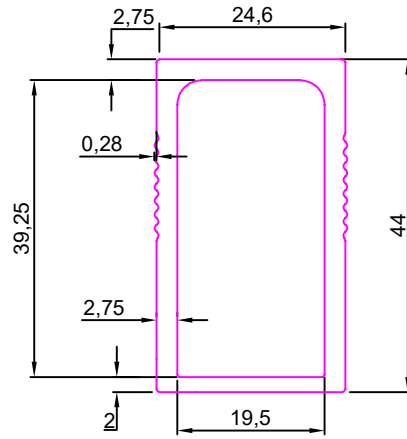

SEC No. 8396

Weight:-3.740Kg/12'

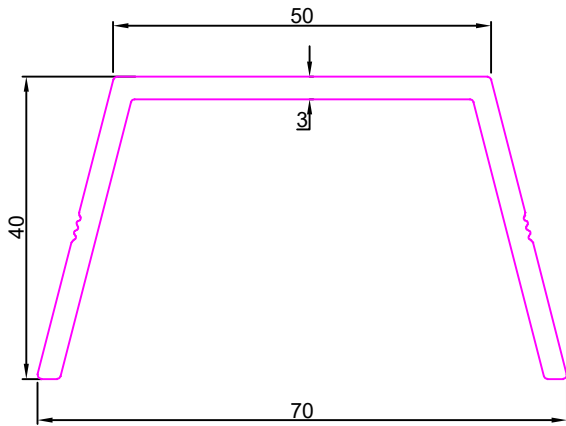

SEC No. 8397

Weight:-13.100Kg/12'

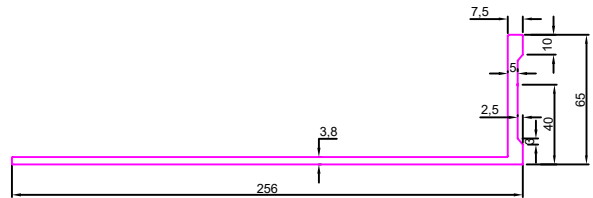

SEC No. 8398

Weight:-14.000Kg/12'

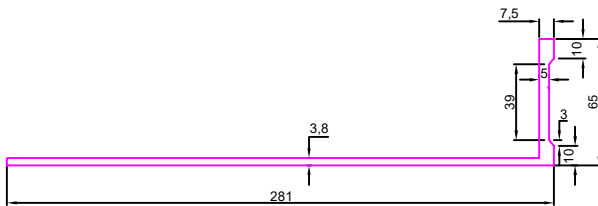

SEC No. 8399

Weight:-14.980Kg/12'

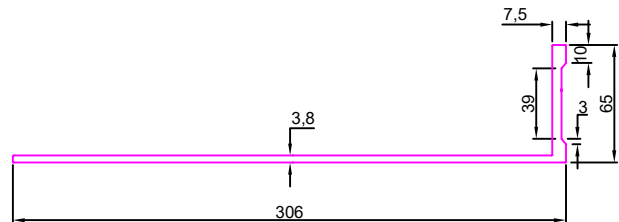



FORM WORKS

SEC No. 8413

Weight:-14.600Kg/12'

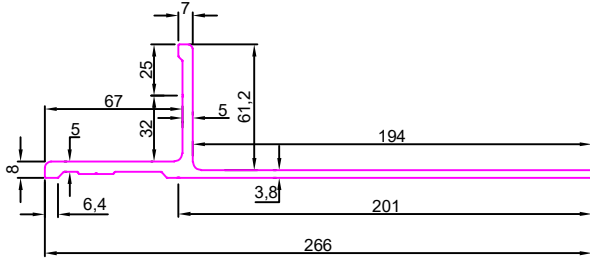

SEC No. 8428

Weight:-13.650Kg/12'

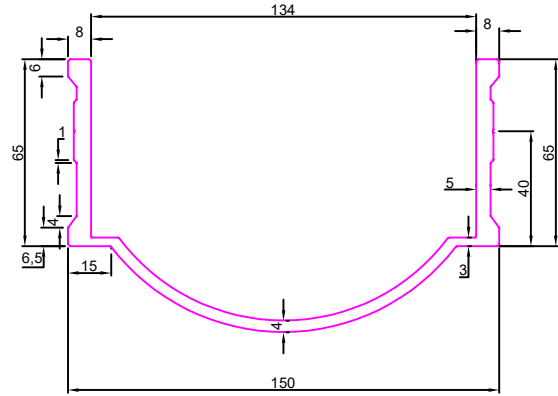

SEC No. 8429

Weight:-5.250Kg/12'

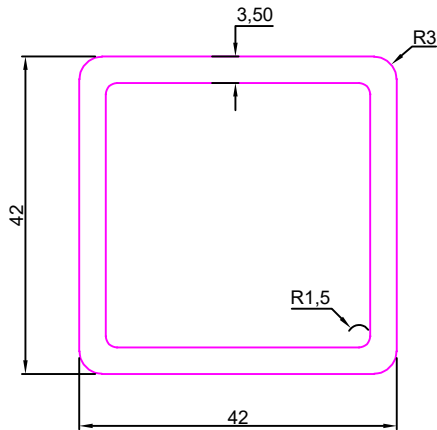

SEC No. 8430

Weight:-4.950Kg/12'

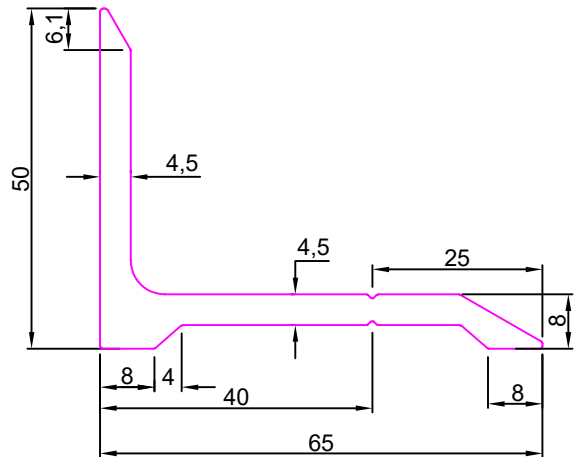

SEC No. 8431

Weight:-3.200Kg/12'

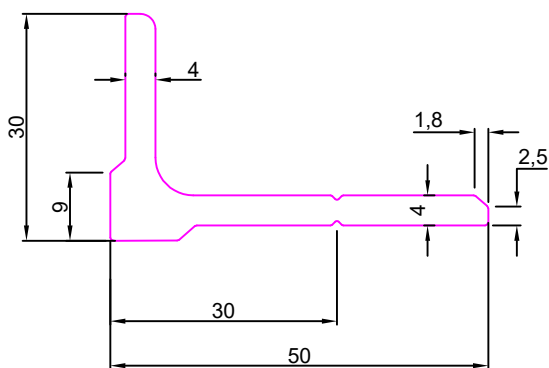

SEC No. 8432

Weight:-21.650Kg/12'

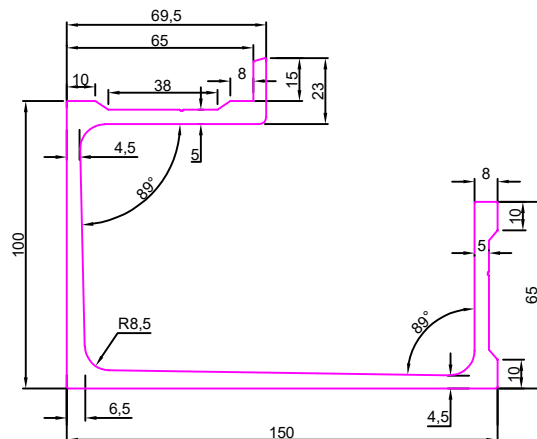



FORM WORKS

SEC No. 8433

Weight:-3.150Kg/12'

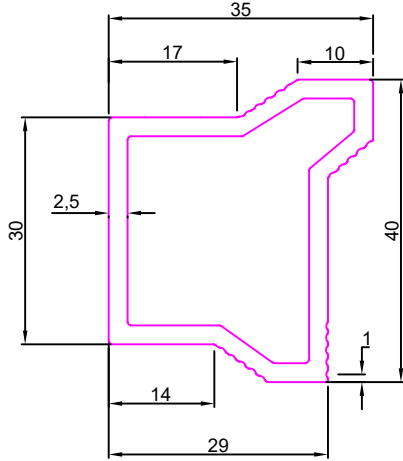

SEC No. 8434

Weight:-4.100Kg/12'

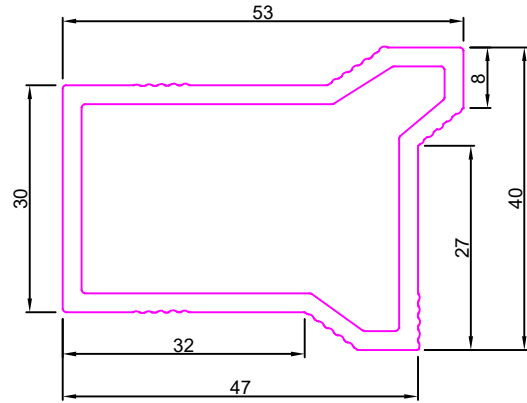

SEC No. 8435

Weight:-7.600Kg/12'

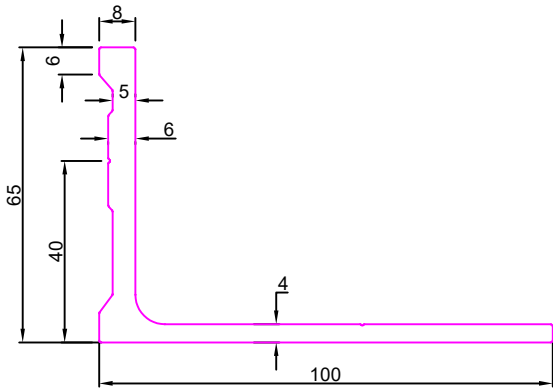

SEC No. 8436

Weight:-8.800Kg/12'

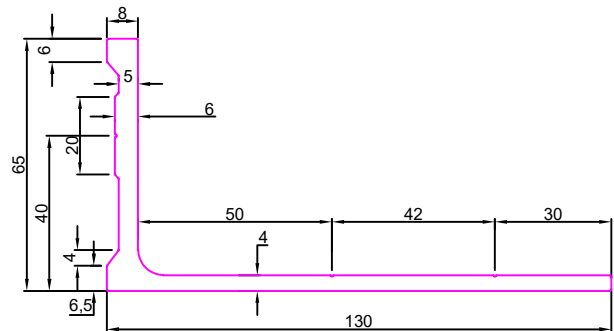

SEC No. 8437

Weight:-9.590Kg/12'

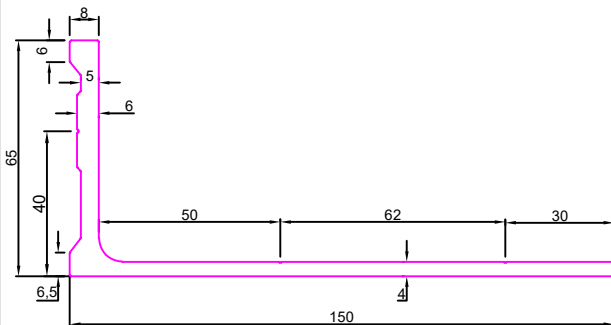

SEC No. 8438

Weight:-10.750Kg/12'

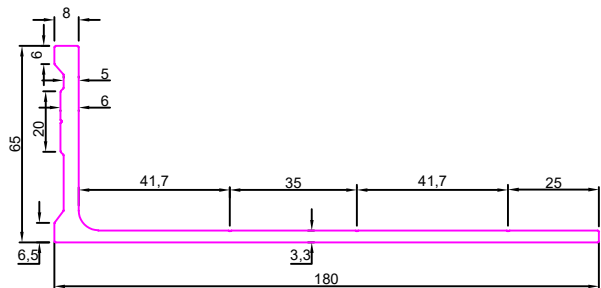



FORM WORKS

SEC No. 8439

Weight:-11.750Kg/12'

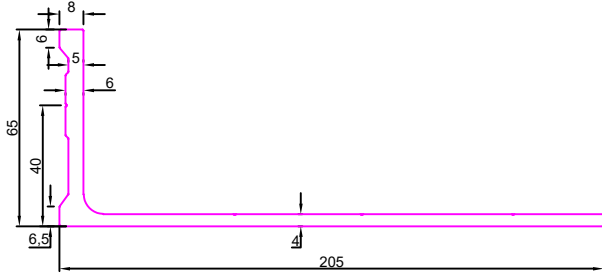

SEC No. 8440

Weight:-12.750Kg/12'

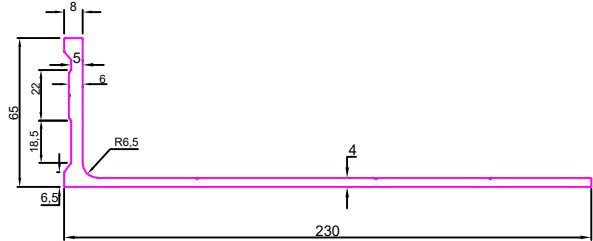

SEC No. 8441

Weight:-13.740Kg/12'

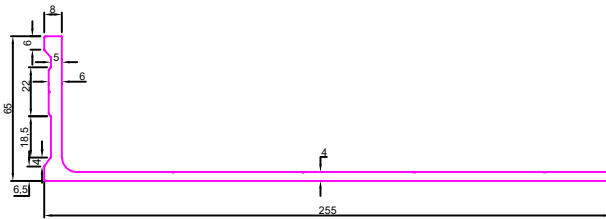

SEC No. 8442

Weight:-14.700Kg/12'

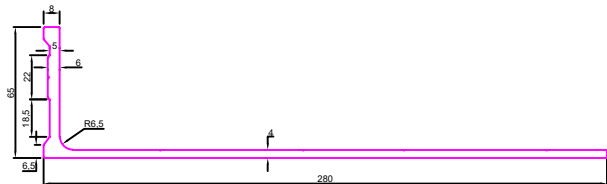

SEC No. 8443

Weight:-15.700Kg/12'

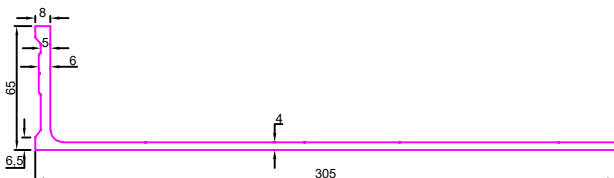

SEC No. 8444

Weight:-9.300Kg/12'

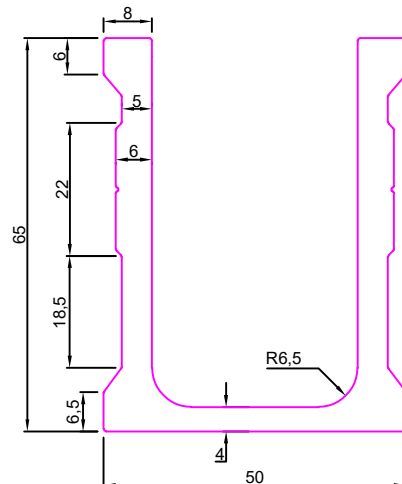



FORM WORKS

SEC No. 8445

Weight:-10.300Kg/12'

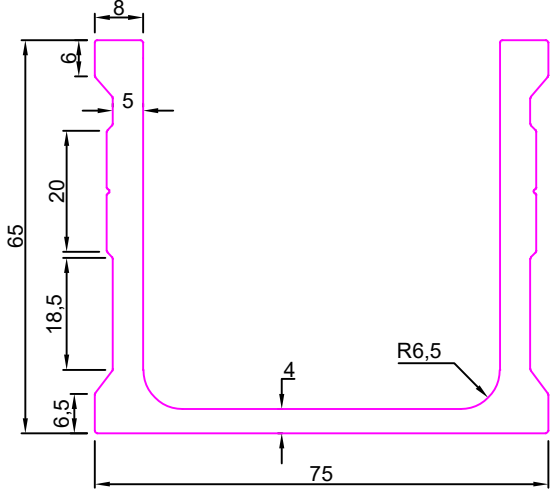

SEC No. 8446

Weight:-10.500Kg/12'

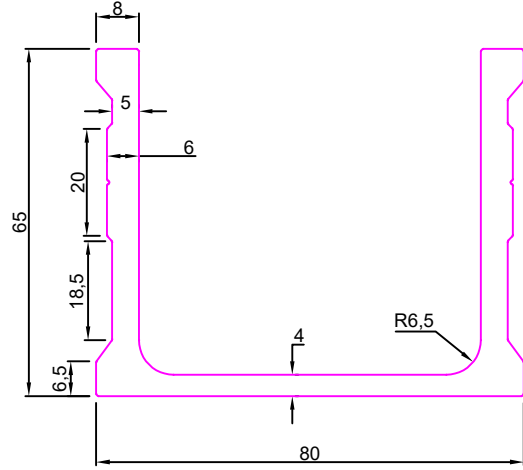

SEC No. 8447

Weight:-10.890Kg/12'

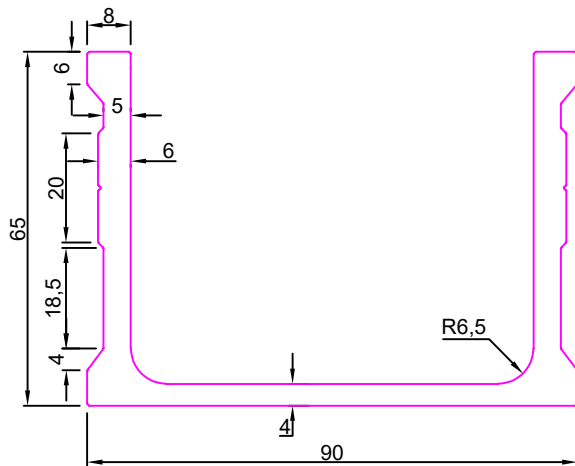

SEC No. 8448

Weight:-11.290Kg/12'

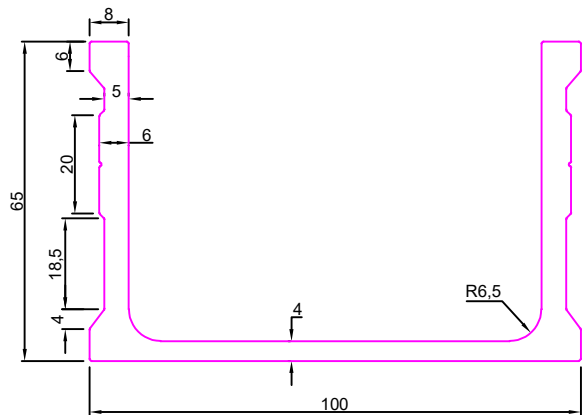

SEC No. 8449

Weight:-12.250Kg/12'

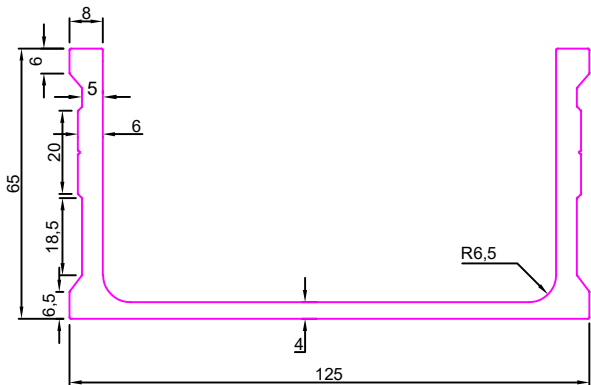

SEC No. 8450

Weight:-13.250Kg/12'

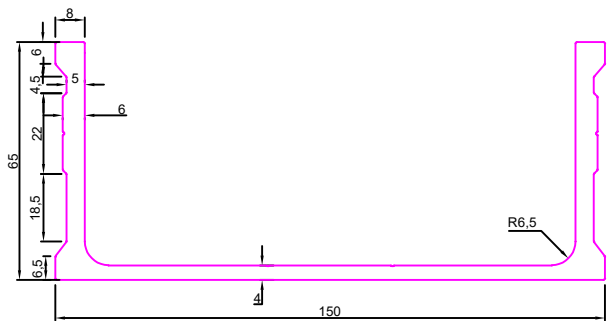



FORM WORKS

SEC No. 8451

Weight:-13.650Kg/12'

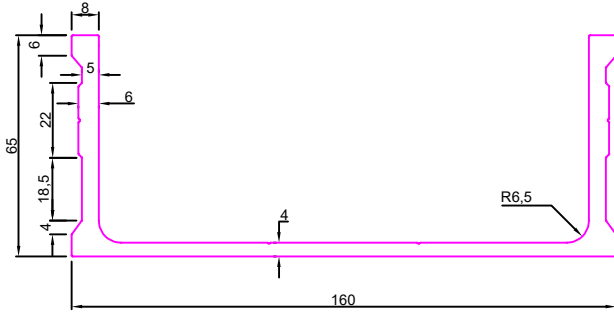

SEC No. 8452

Weight:-14.250Kg/12'

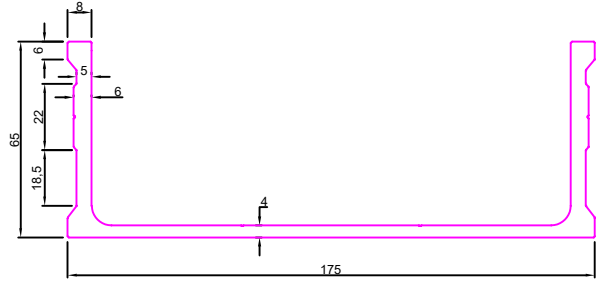

SEC No. 8453

Weight:-15.200Kg/12'

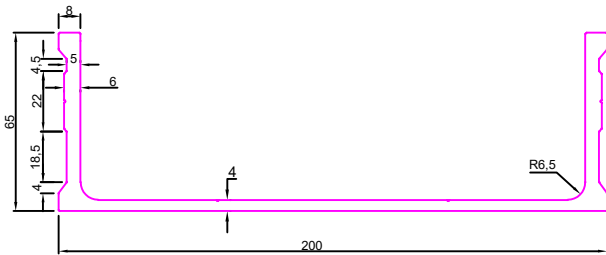

SEC No. 8454

Weight:-16.200Kg/12'

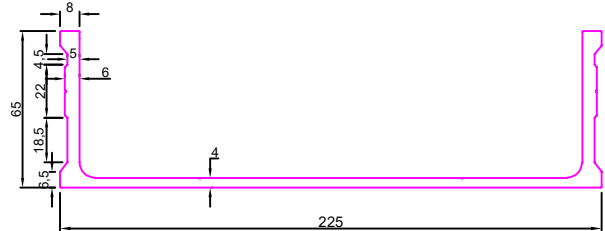

SEC No. 8455

Weight:-16.400Kg/12'

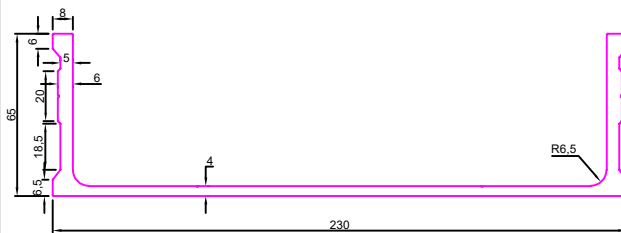

SEC No. 8456

Weight:-16.800Kg/12'

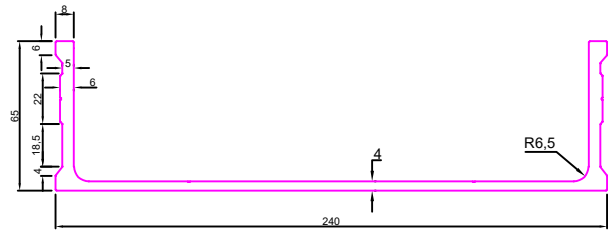



FORM WORKS

SEC No. 8457

Weight:-17.200Kg/12'

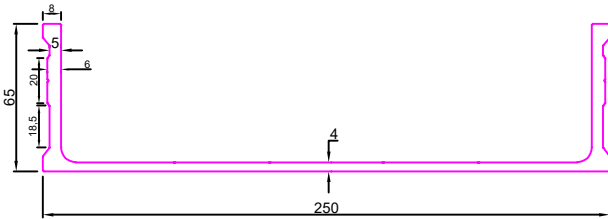

SEC No. 8458

Weight:-17.600Kg/12'

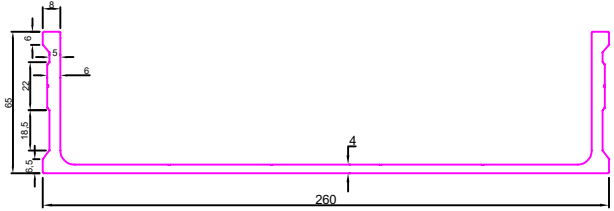

SEC No. 8459

Weight:-18.200Kg/12'

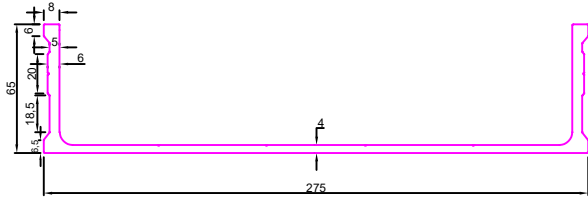

SEC No. 8460

Weight:-19.190Kg/12'

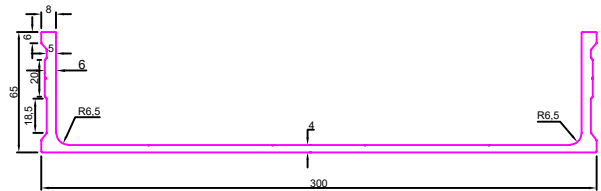

SEC No. 8461

Weight:-10.100Kg/12'

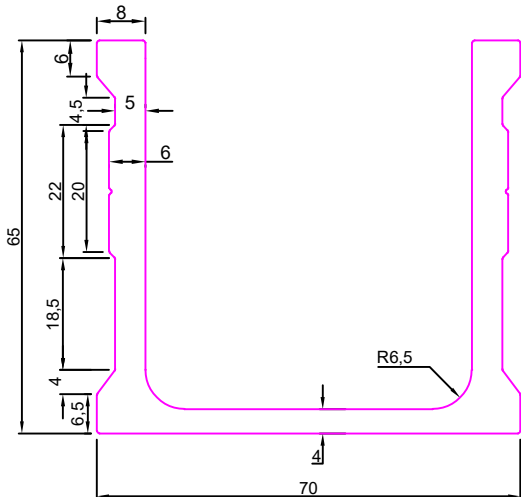

SEC No. 8462

Weight:-9.900Kg/12'

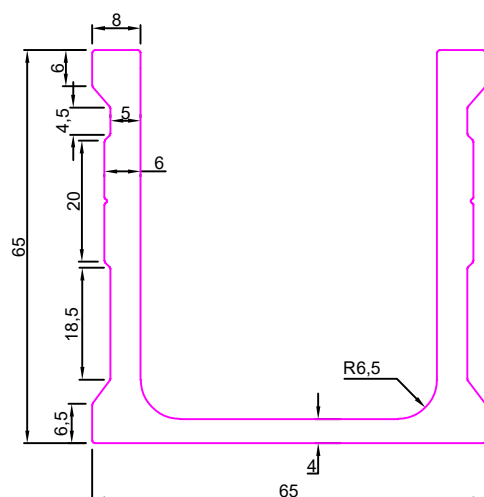



FORM WORKS

SEC No. 8463

Weight:-9.700Kg/12'

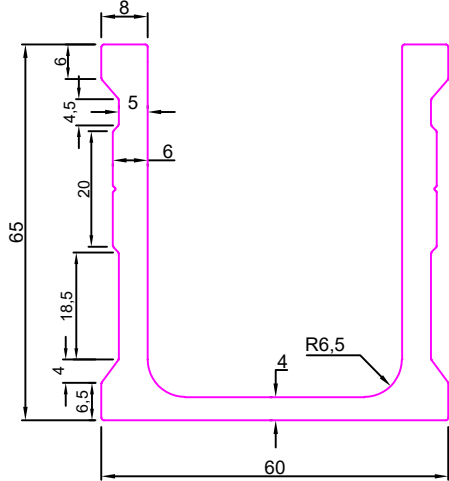

SEC No. 8464

Weight:-3.550Kg/12'

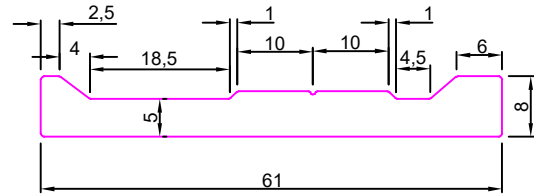

SEC No. 8465

Weight:-5.400Kg/12'

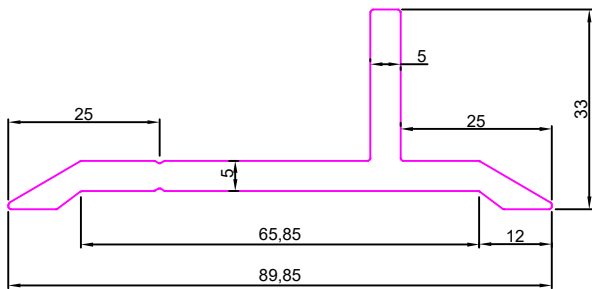

SEC No. 8466

Weight:-14.400Kg/12'

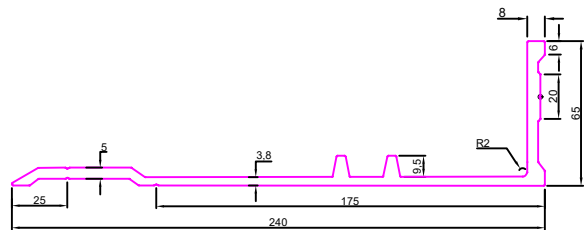

SEC No. 8467

Weight:-5.850Kg/12'

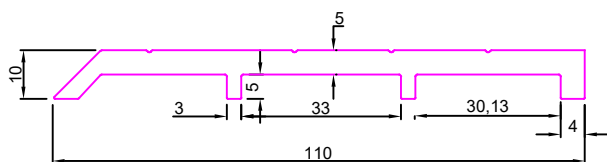

SEC No. 8483

Weight:-18.750Kg/12'

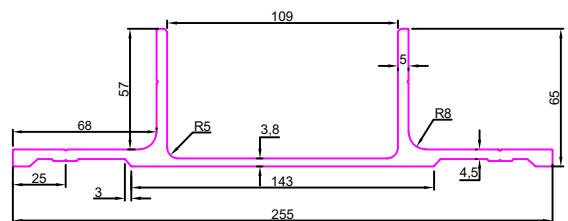



FORM WORKS

SEC No. 8484

Weight:-3.940Kg/12'

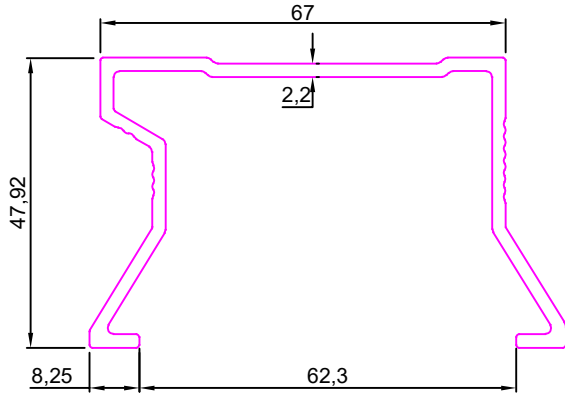

SEC No. 8486

Weight:-4.150Kg/12'

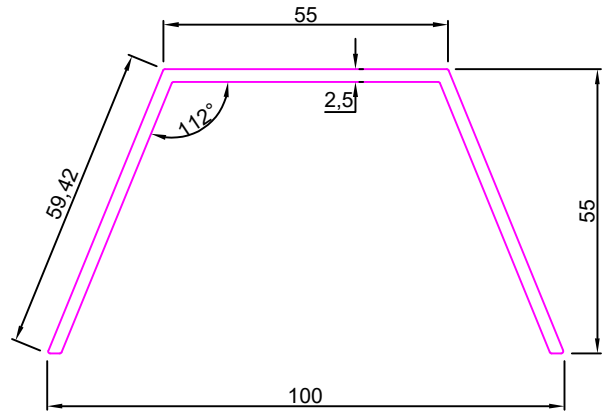

SEC No. 8487

Weight:-4.540Kg/12'

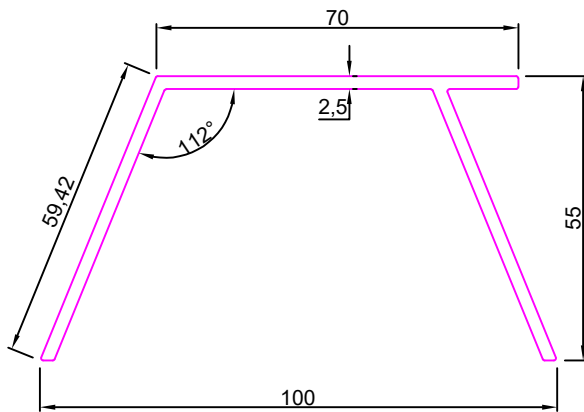

SEC No. 8501

Weight:-18.000Kg/12'

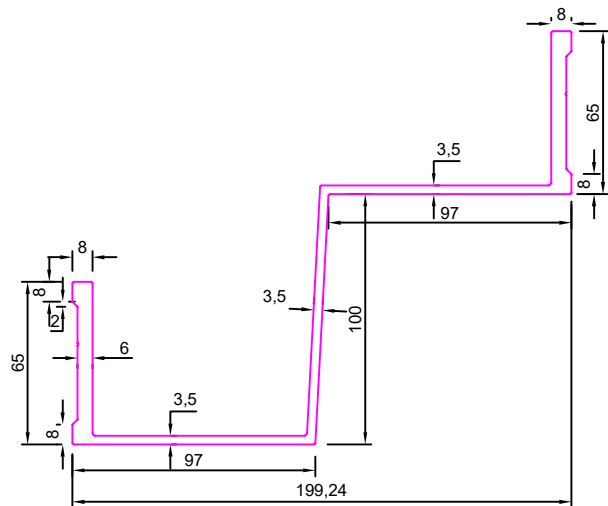

SEC No. 8614

Weight:-3.800Kg/12'

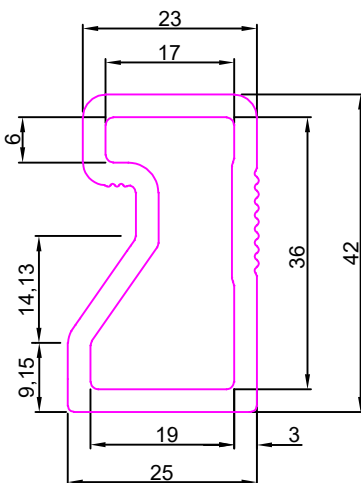

SEC No. 8615

Weight:-5.700Kg/12'

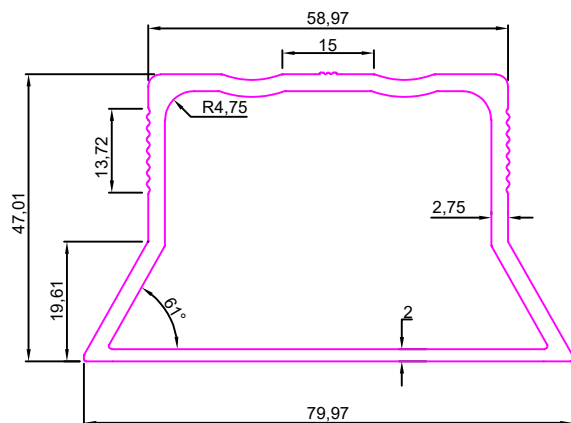



FORM WORKS

SEC No. 8616

Weight:-21.450Kg/12'

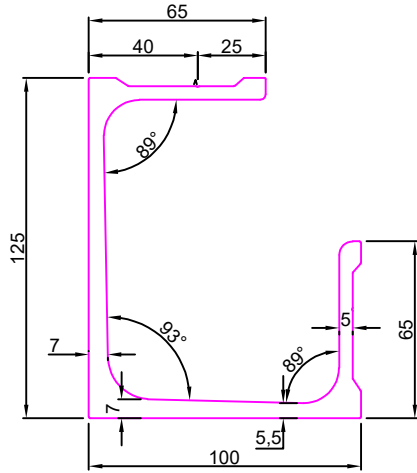

SEC No. 8617

Weight:-22.425Kg/12'

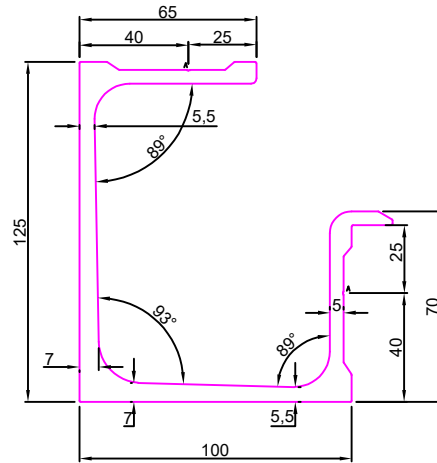

SEC No. 8639

Weight:10.985Kg/12'

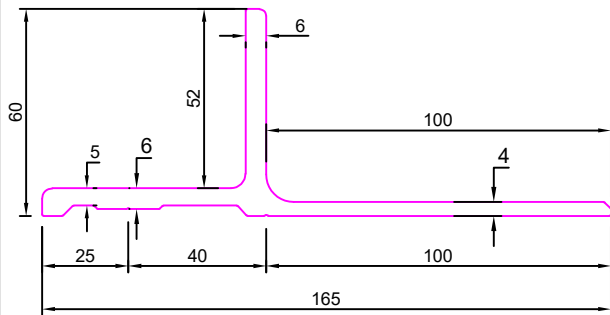

SEC No. 8640

Weight:12.965Kg/12'

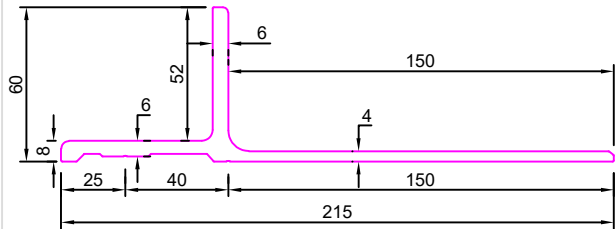

SEC No. 8641

Weight:10.000Kg/12'

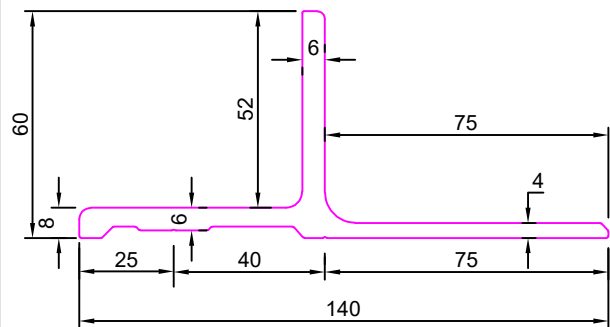

SEC No. 8645

Weight:14.975Kg/12'

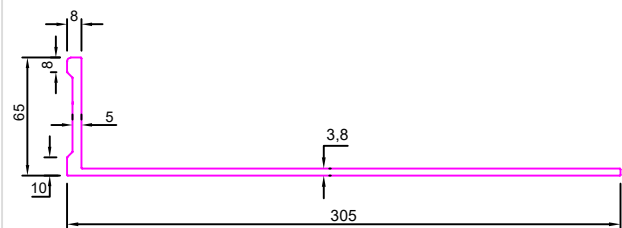



FORM WORKS

SEC No. 8663

Weight:12.800Kg/12'

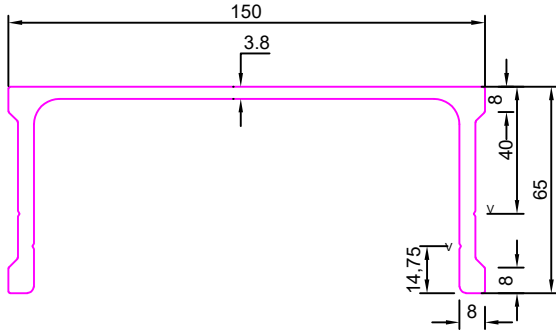

SEC No. 8670

Weight:-13.980Kg/12'

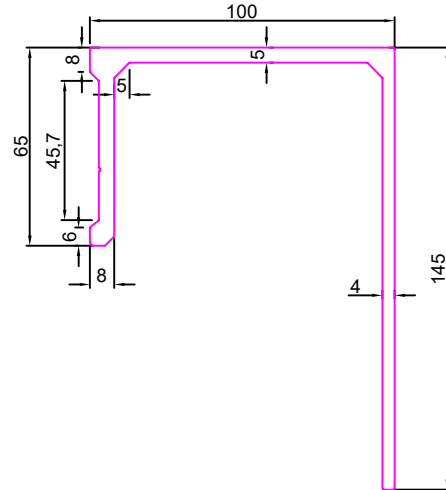

SEC No. MA8673

Weight:-12.155Kg/12'

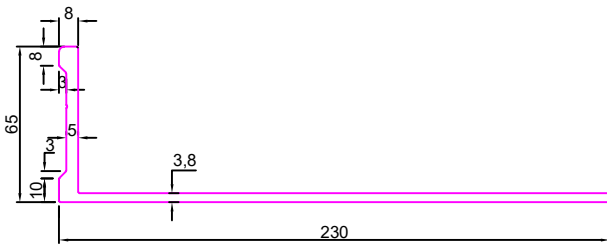

SEC No. MA8674

Weight:-11.215Kg/12'

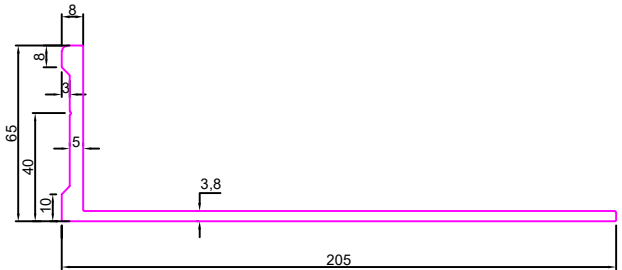

SEC No. VA8675

Weight:-13.095Kg/12'

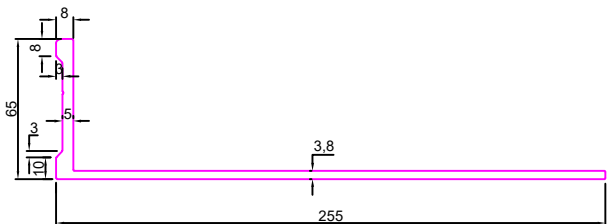

SEC No. VA8676

Weight:-14.035Kg/12'

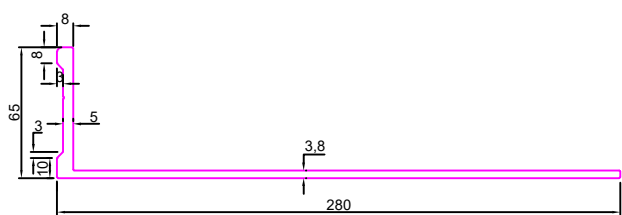



FORM WORKS

SEC No. 8677

Weight:-9.220Kg/12'

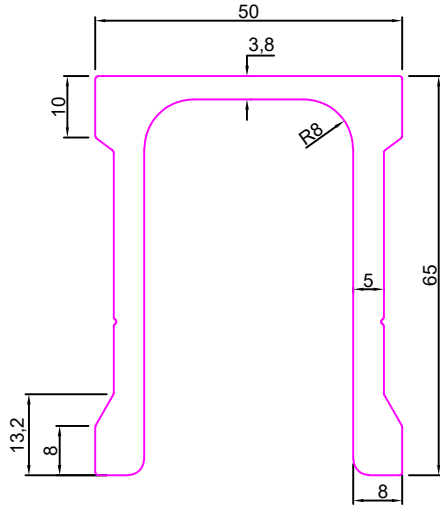

SEC No. 8678

Weight:-10.160Kg/12'

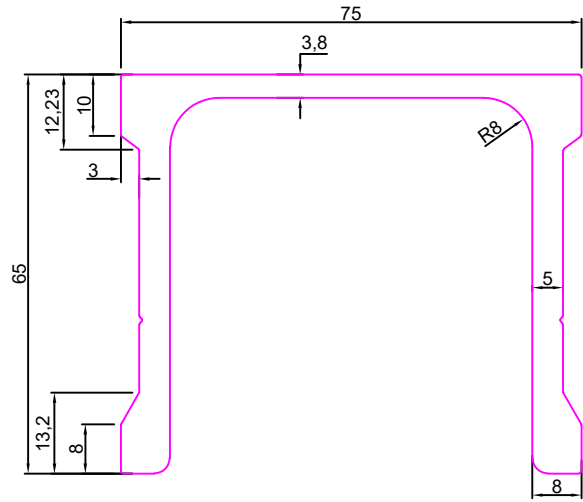

SEC No. 8679

Weight:-10.350Kg/12'

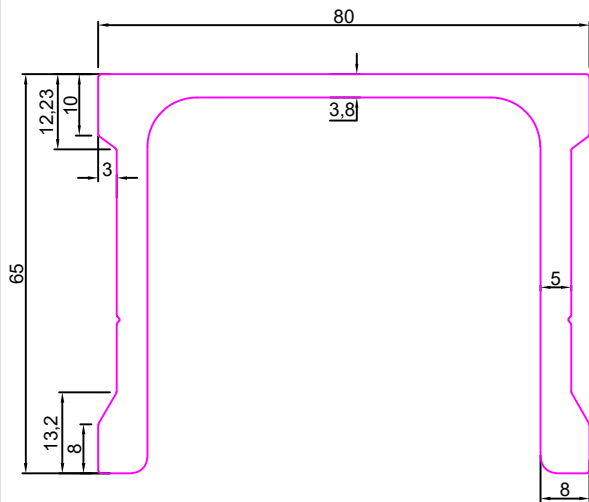

SEC No. 8680

Weight:-10.535Kg/12'

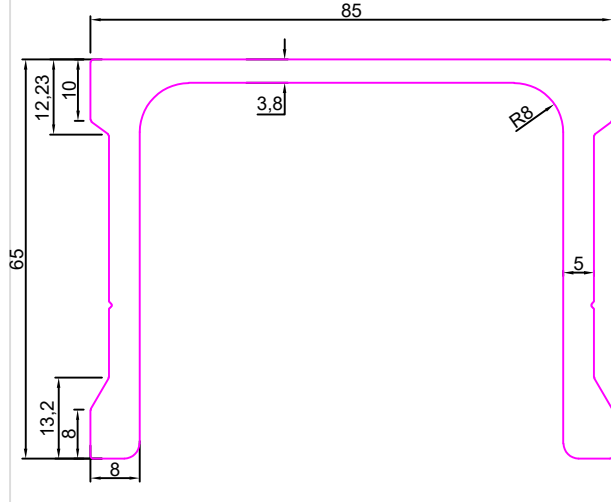

SEC No. 8681

Weight:-10.725Kg/12'

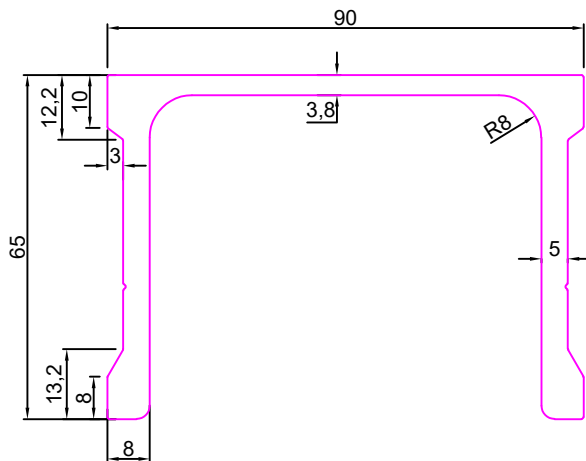

SEC No. 8682

Weight:-10.910Kg/12'

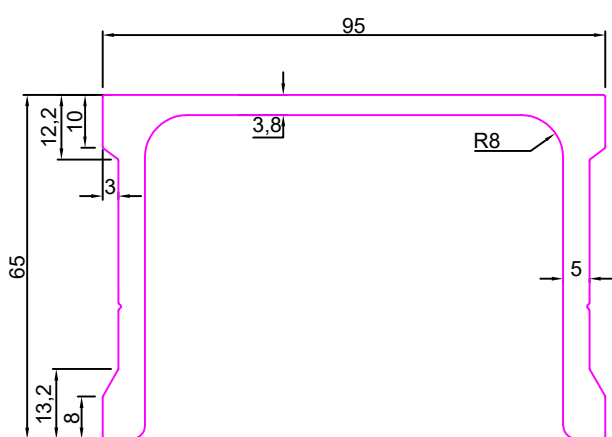



FORM WORKS

SEC No. 8683

Weight:-11.100Kg/12'

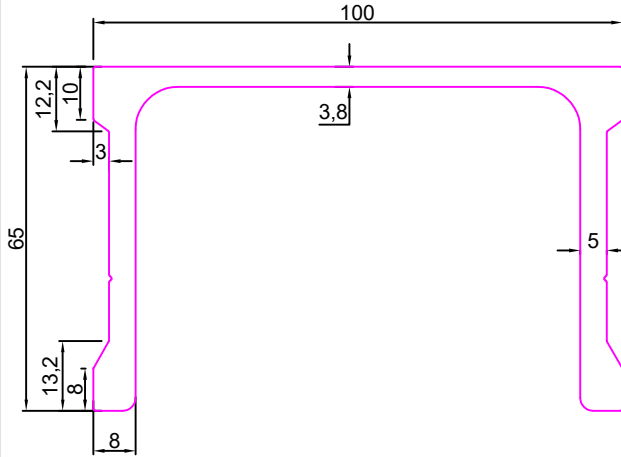

SEC No. 8684

Weight:-11.285Kg/12'

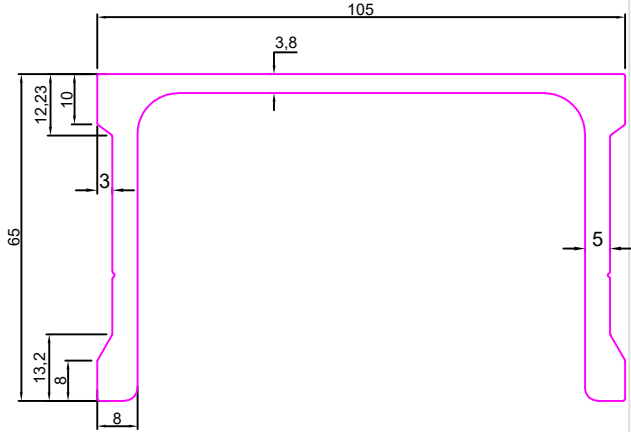

SEC No. 8685

Weight:-11.475Kg/12'

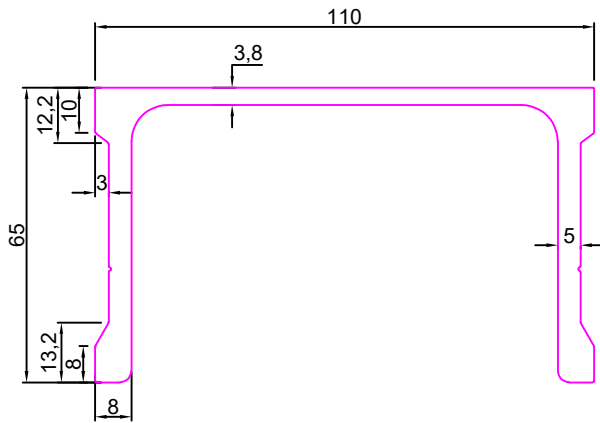

SEC No. 8686

Weight:-11.665Kg/12'

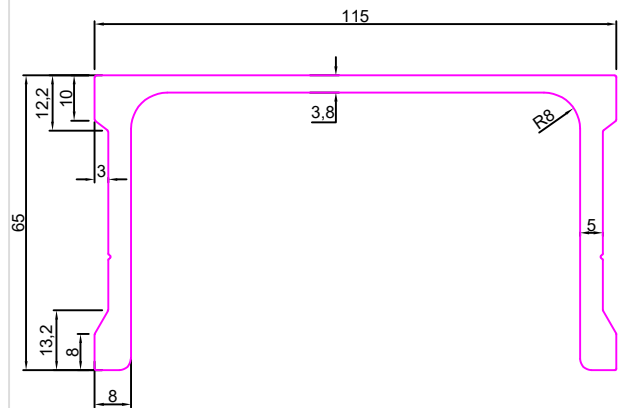

SEC No. 8687

Weight:-11.850Kg/12'

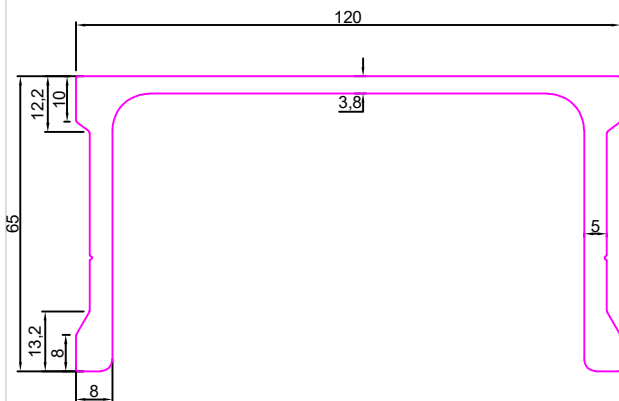

SEC No. 8688

Weight:-12.040Kg/12'

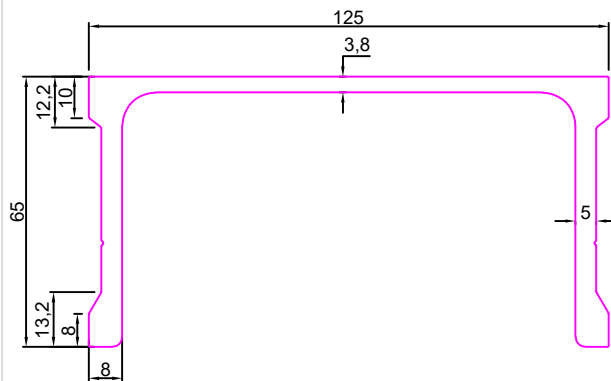



FORM WORKS

SEC No. 8689

Weight:-12.225Kg/12'

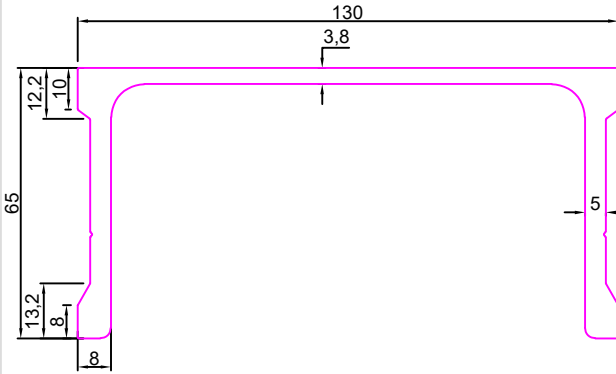

SEC No. 8690

Weight:-12.415Kg/12'

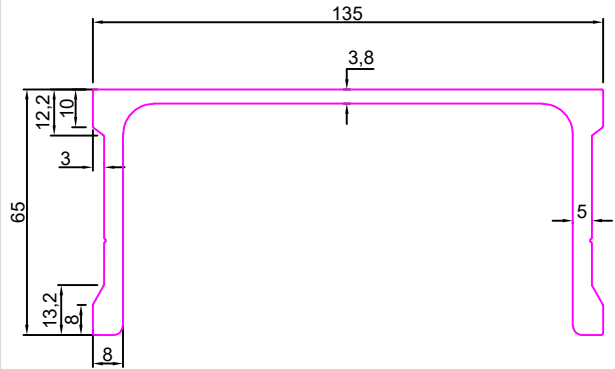

SEC No. 8691

Weight:-12.600Kg/12'

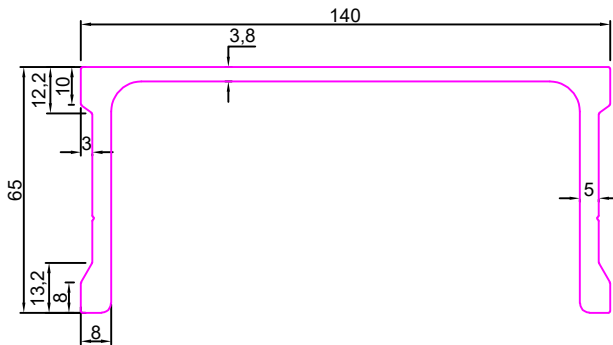

SEC No. 8692

Weight:-12.790Kg/12'

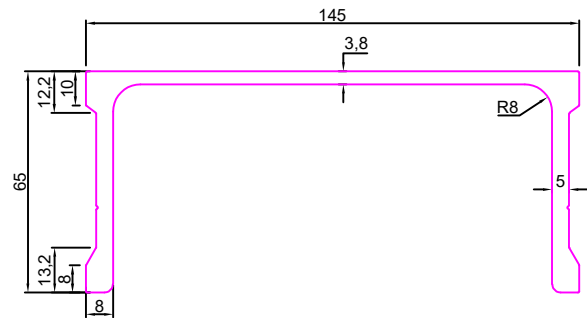

SEC No. 8693

Weight:-12.975Kg/12'

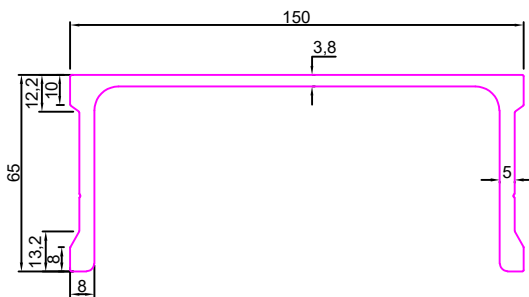

SEC No. 8694

Weight:-13.165Kg/12'

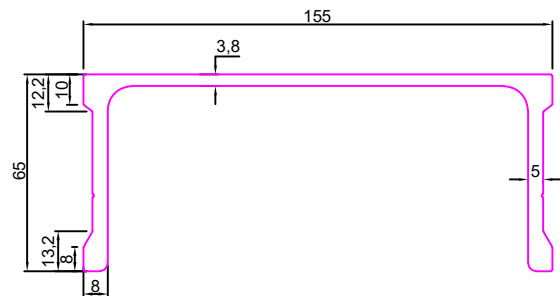



FORM WORKS

SEC No. 8695

Weight:-13.350Kg/12'

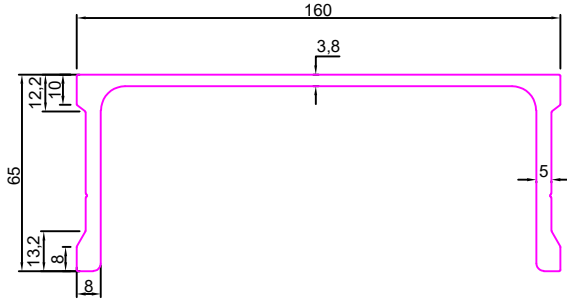

SEC No. 8696

Weight:-13.540Kg/12'

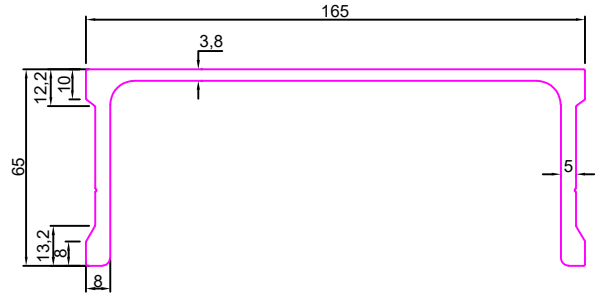

SEC No. 8697

Weight:-13.730Kg/12'

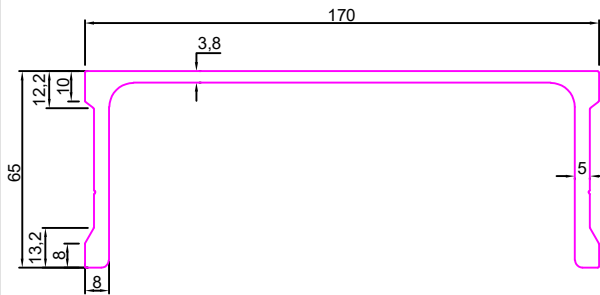

SEC No. 8698

Weight:-13.915Kg/12'

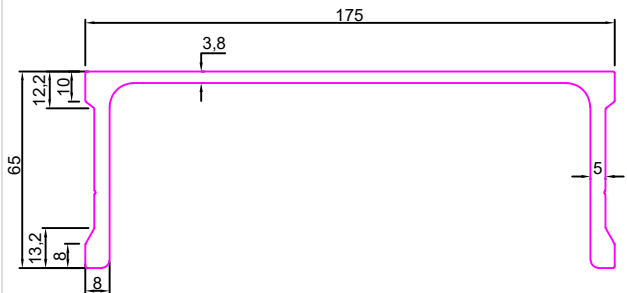

SEC No. 8699

Weight:-14.100Kg/12'

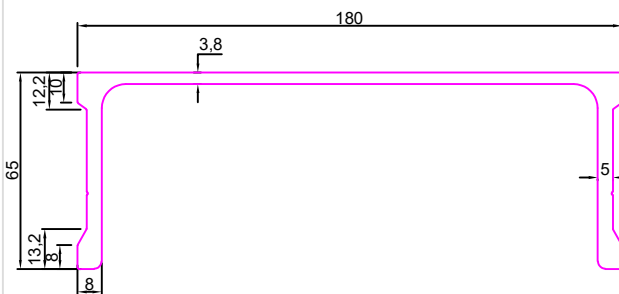

SEC No. 8700

Weight:-14.290Kg/12'

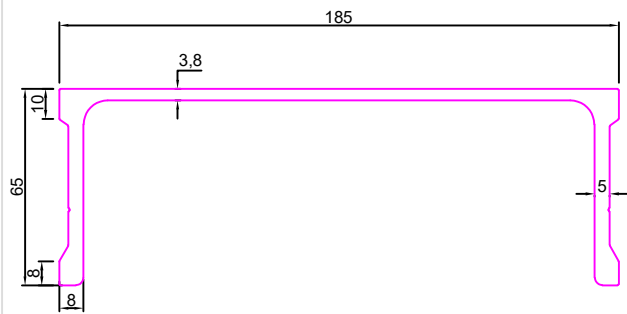



FORM WORKS

SEC No. 8701

Weight:-14.480Kg/12'

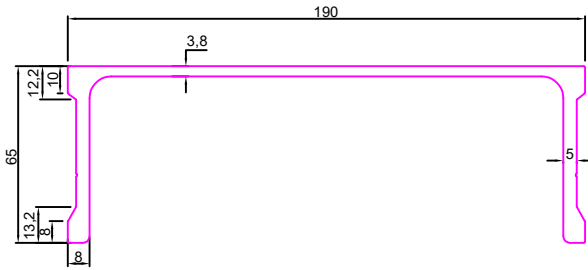

SEC No. 8702

Weight:-14.665Kg/12'

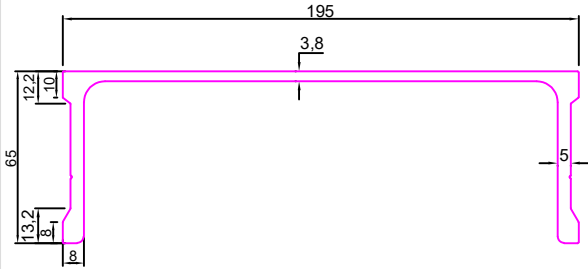

SEC No. 8703

Weight:-14.855Kg/12'

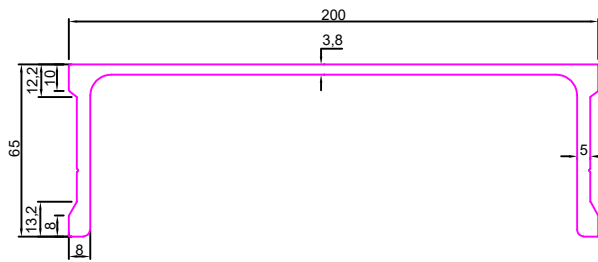

SEC No. 8704

Weight:-15.795Kg/12'

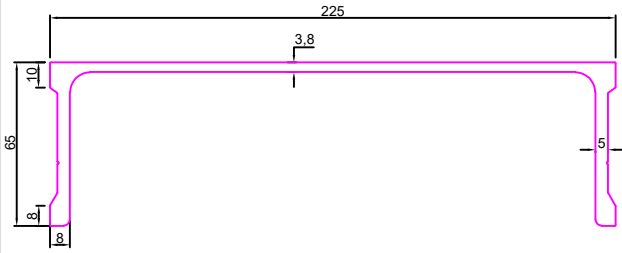

SEC No. 8705

Weight:-16.730Kg/12'

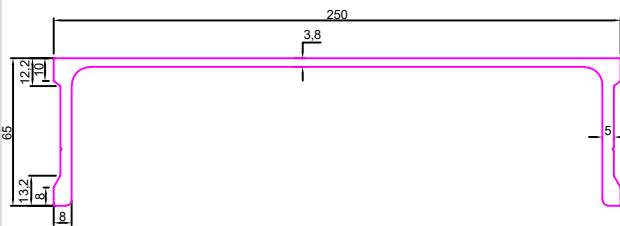

SEC No. 8706

Weight:-17.670Kg/12'

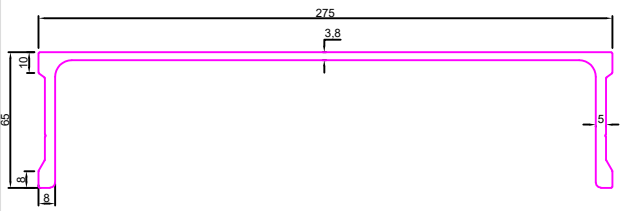



FORM WORKS

SEC No. 8707

Weight:-18.610Kg/12'

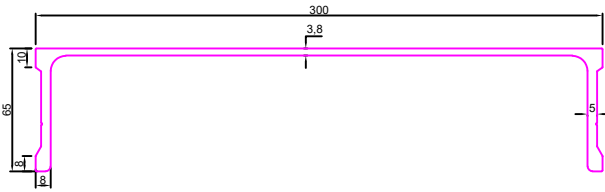

SEC No. 8710

Weight:-7.460Kg/12'

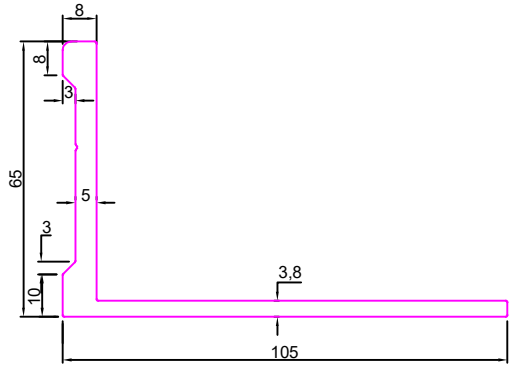

SEC No. 8711

Weight:-8.400Kg/12'

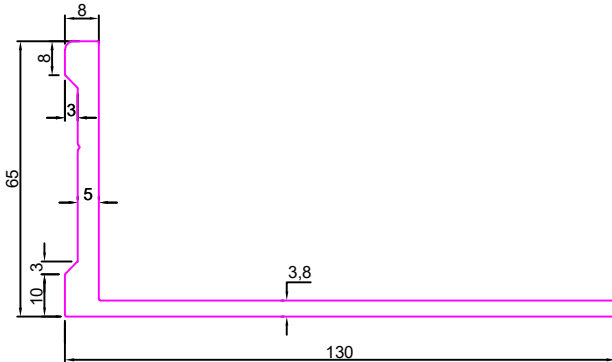

SEC No. 8712

Weight:-9.340Kg/12'

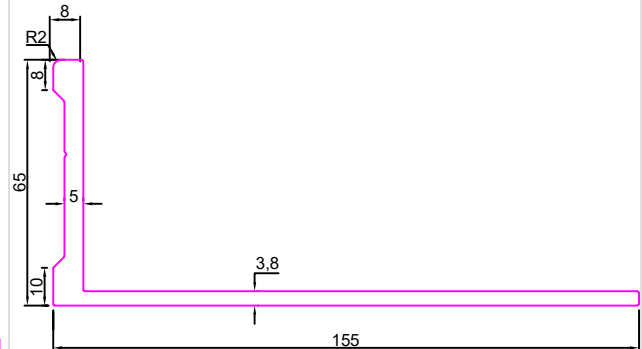

SEC No. 8713

Weight:-11.215Kg/12'

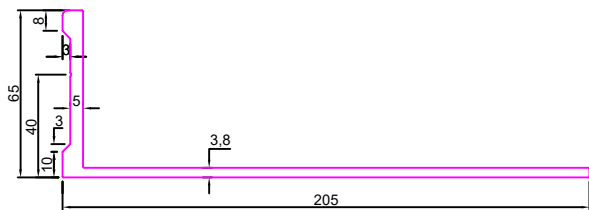

SEC No. 8714

Weight:-12.155Kg/12'





FORM WORKS

SEC No. 8715

Weight:-13.095Kg/12'

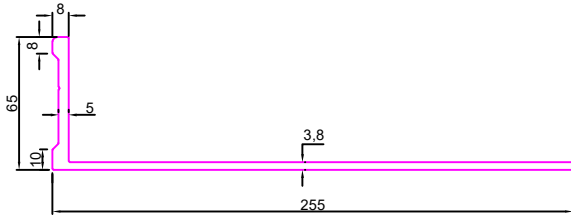

SEC No. 8716

Weight:-14.035Kg/12'

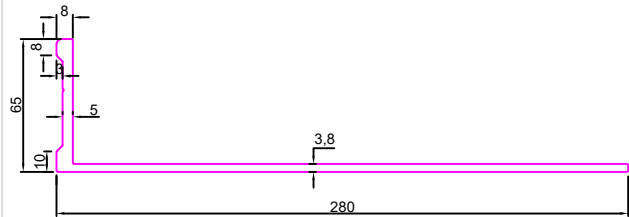

SEC No. 8717

Weight:-14.970Kg/12'

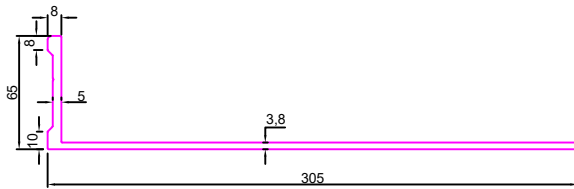

SEC No. 8718

Weight:-10.275Kg/12'

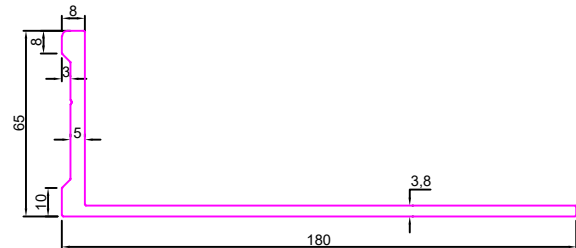

SEC No. MA8728

Weight:-10.275Kg/12'

