

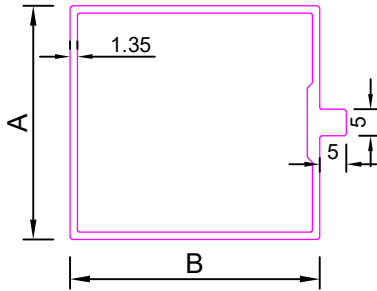

CURTAIN WALL



SEC. NO.	A	B	L	T	Wt.(KG/12')
4501	44.00	47.50	5.00	2.00	2.000-2.200
4502	50.00	50.00	5.00	2.00	2.800-3.000
4503	44.00	44.00	10.0	1.40	2.700-3.000
4504	58.00	64.00	10.0	1.50	3.900-4.100

SEC NO. :-2031

Weight :- 1.100kg/12'

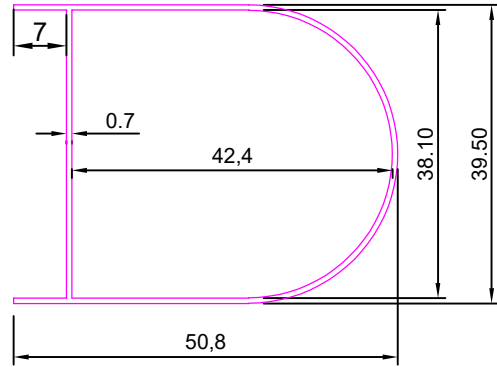

SEC. NO:-4511

Weight :- 7.656kg/12'

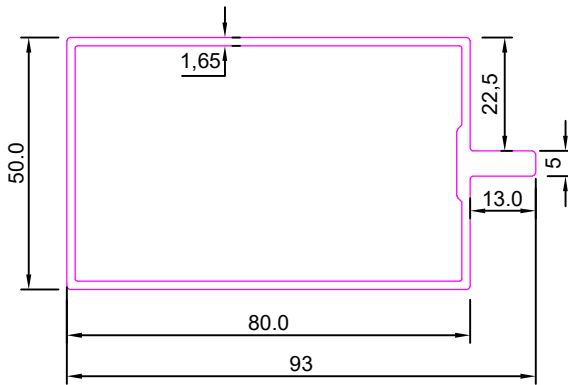

SEC. NO:- 4516

Weight :- 5.765kg/12'

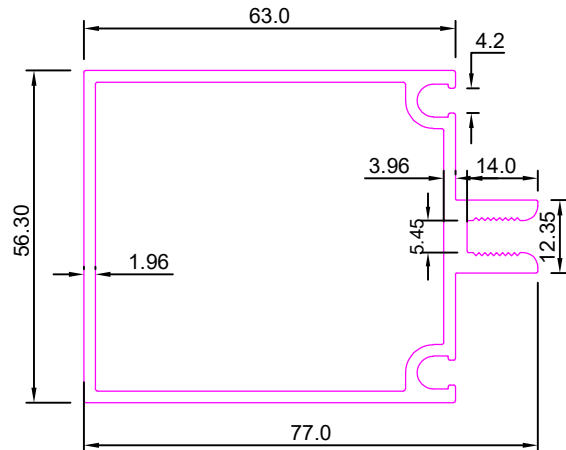

SEC. NO:- 4521

Weight :- 5.550kg/12'

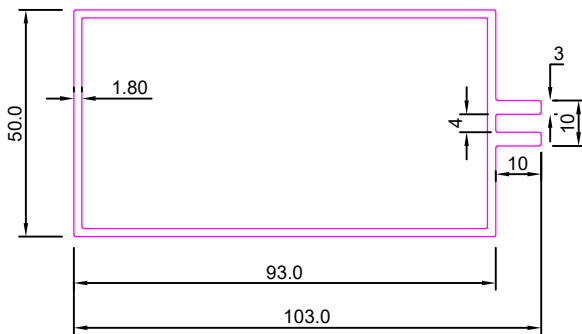

SEC. NO:- 4526

Weight :- 4.510kg/12'

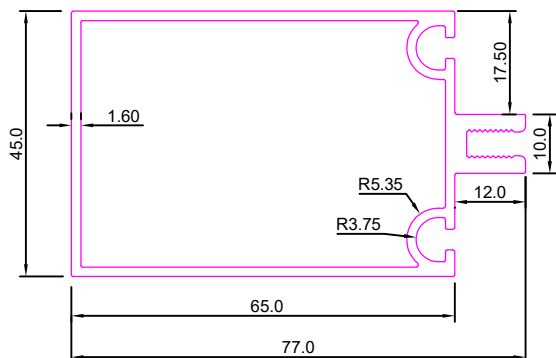



CURTAIN WALL

SEC. NO:- 4531

Weight :- 8.710kg/12'



SEC. NO:- 4532

Weight :- 7.800kg/12'

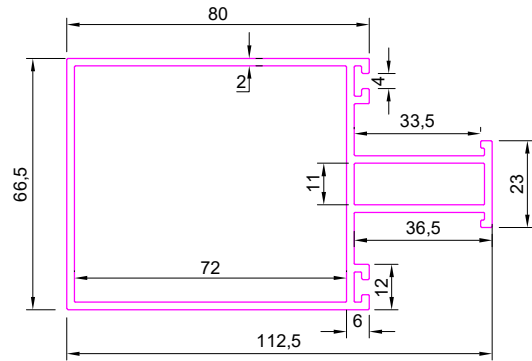

SEC. NO:- 4536

Weight :- 6.620kg/12'

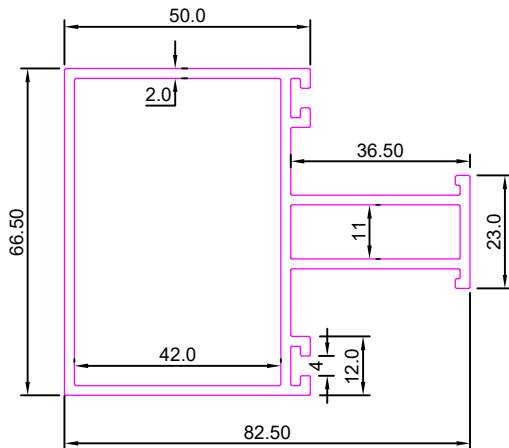

SEC. NO:- 4541

Weight :- 6.450kg/12'

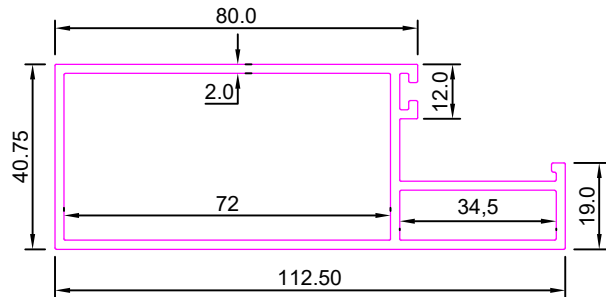

SEC. NO:- 4546

Weight :- 1.515kg/12'

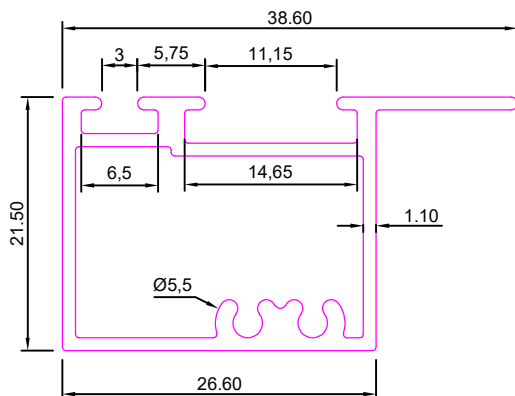

SEC. NO:- 4551

Weight :- 6.340kg/12'

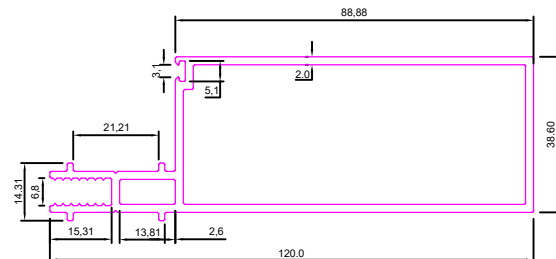



CURTAIN WALL

SEC. NO:- 4556

Weight :- 1.340kg/12'

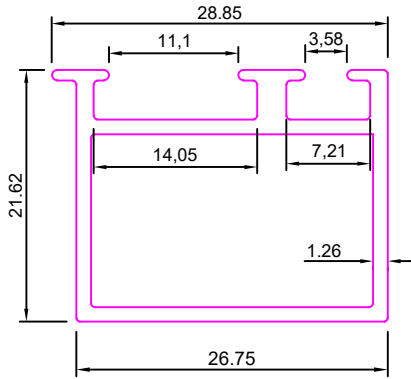

SEC. NO:- 4561

Weight :- 6.100kg/12'

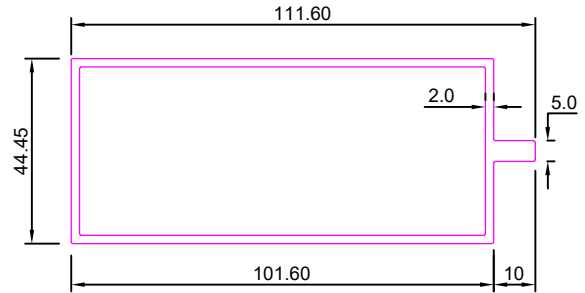

SEC. NO:- 4563

Weight :- 4.050kg/12'

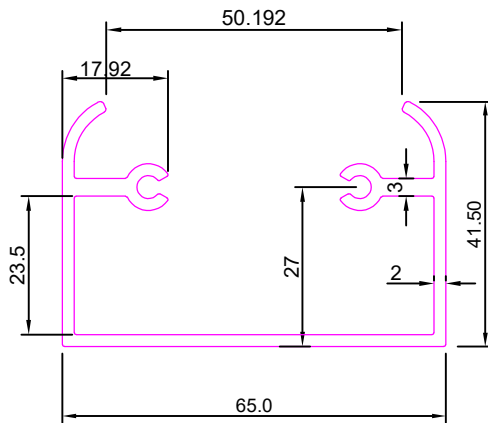

SEC. NO:- 4565

Weight :- 2.330kg/12'

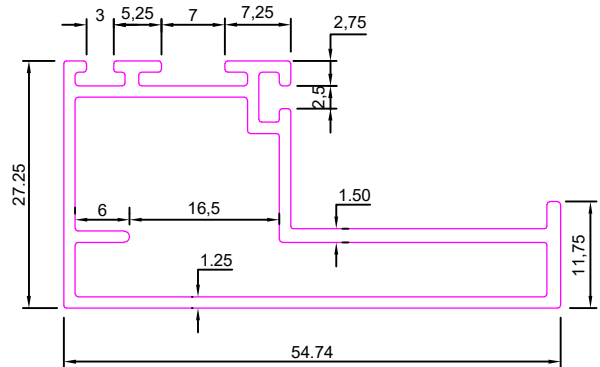

SEC. NO:- 4567

Weight :- .660kg/12'

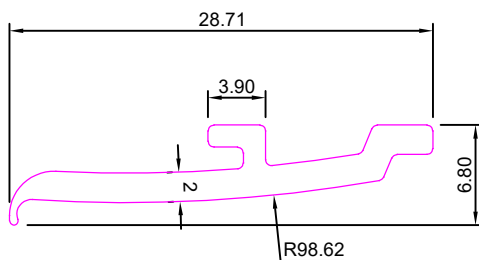

SEC. NO:- 4569

Weight :-5.900kg/12'

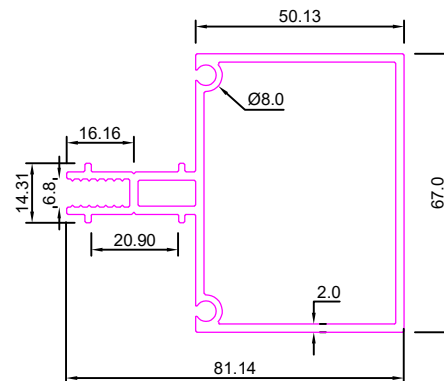



CURTAIN WALL

SEC. NO:- 4571

Weight :- 7.500kg/12'

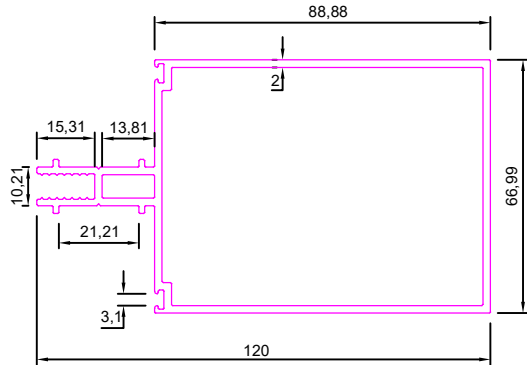

SEC. NO:- 4573

Weight :- 3.080kg/12'

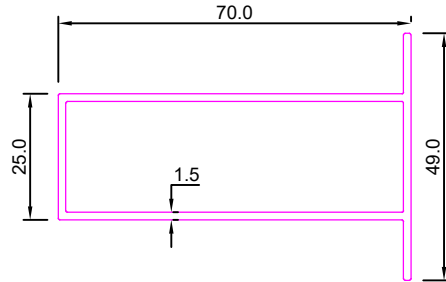

SEC. NO:- 4575

Weight :- 2.900kg/12'

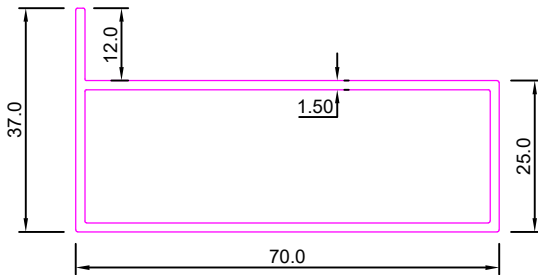

SEC. NO:- 4577

Weight :-3.940kg/12'

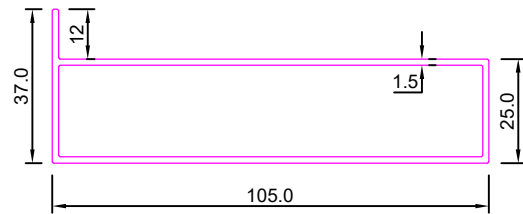

SEC. NO:- 4579

Weight :- 4.120kg/12'

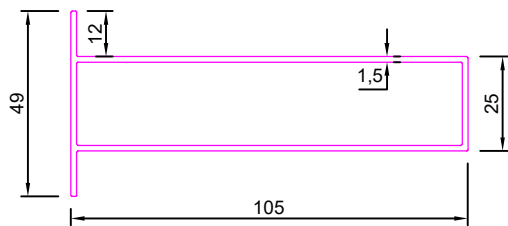

SEC. NO:- 4581

Weight :- 5.000kg/12'

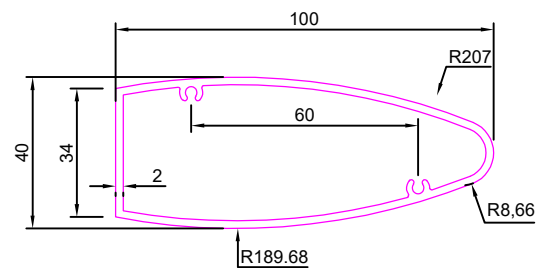



CURTAIN WALL

SEC. NO:- 4583

Weight :- 5.065kg/12'

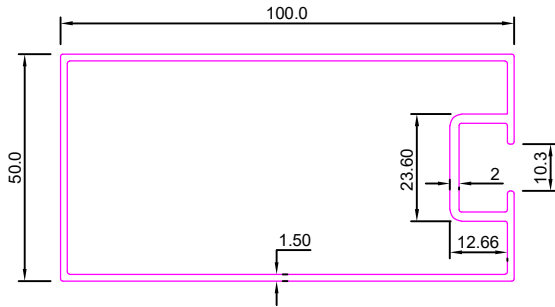

SEC. NO:- 4585

Weight :- 3.900kg/12'

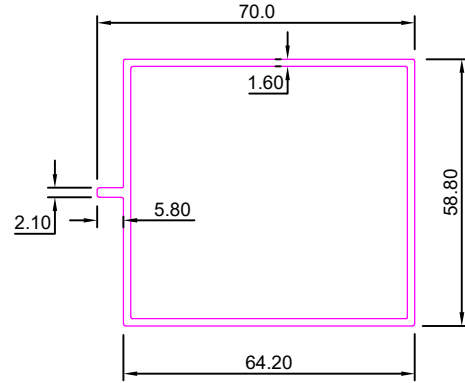

SEC. NO:- 4587

Weight :- 5.050kg/12'

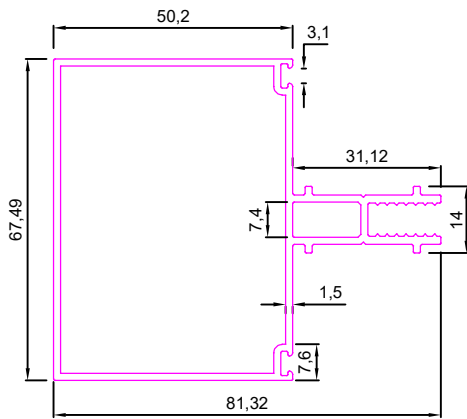

SEC. NO:- 4589

Weight :- 1.980kg/12'

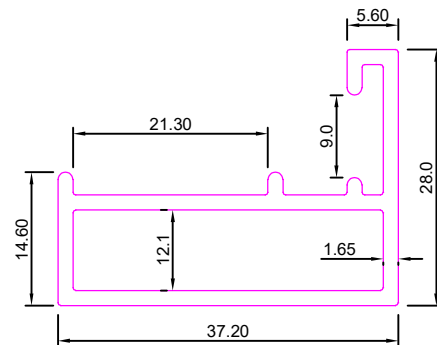

SEC. NO:- 4591

Weight :- 4.900kg/12'

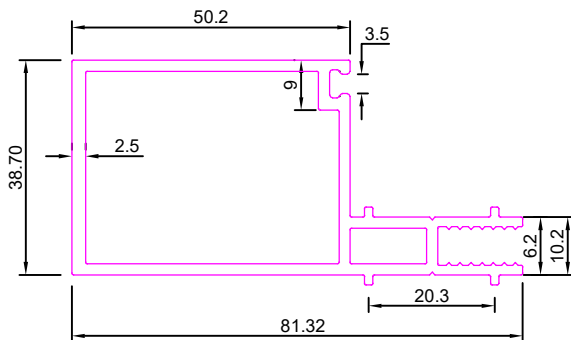

SEC. NO:- 4593

Weight :- 1.070kg/12'

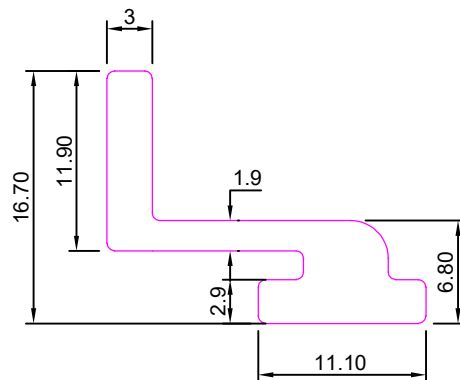



CURTAIN WALL

SEC. NO:- 4595

Weight :- 4.745kg/12'

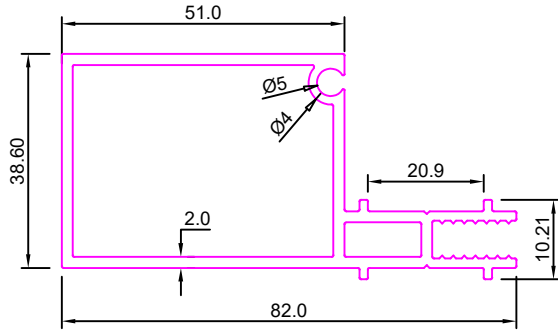

SEC. NO:- 4597

Weight :- 1.750kg/12'

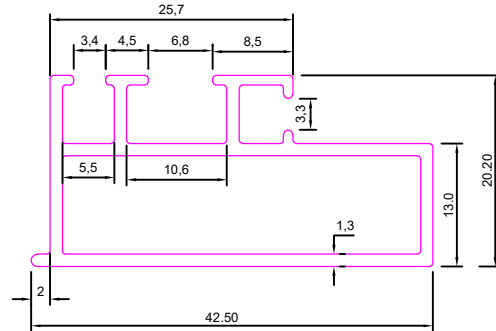

SEC. NO:- 4599

Weight :- 6.260kg/12'

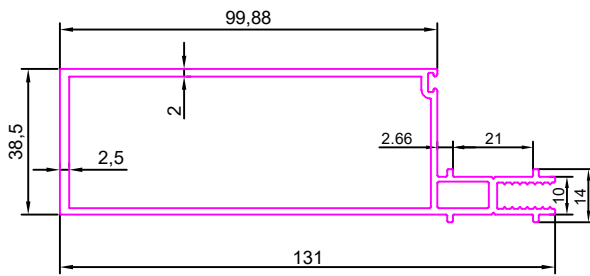

SEC. NO:- 4601

Weight :- 9.200kg/12'

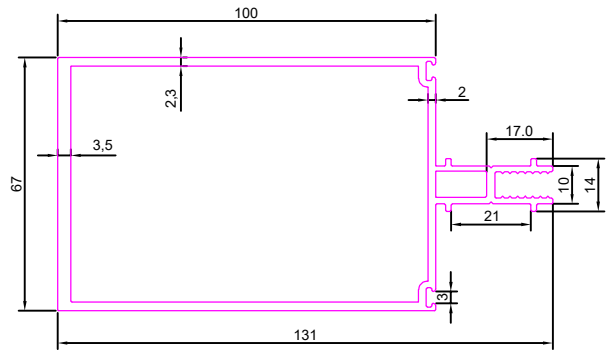

SEC. NO:- 4603

Weight :- 2.250kg/12'

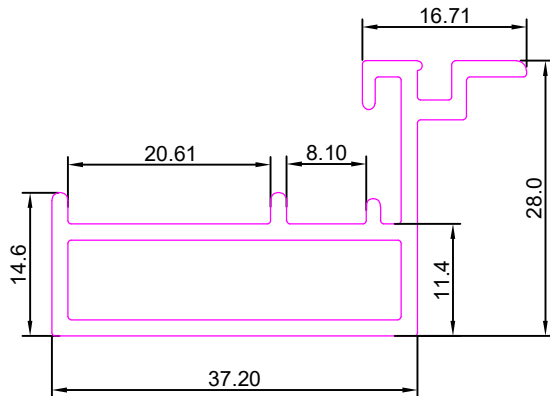

SEC. NO:- 4605

Weight :- 10.00kg/12'

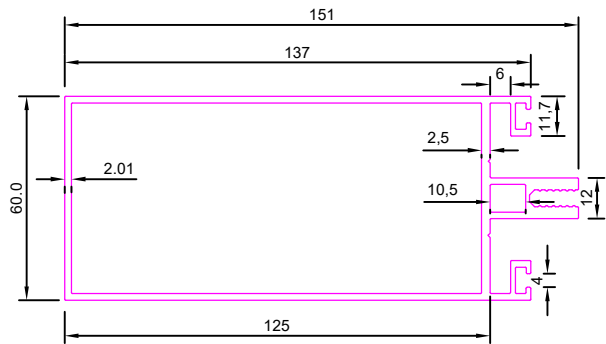



CURTAIN WALL

SEC. NO:-5889

Weight :- 1.300kg/12'

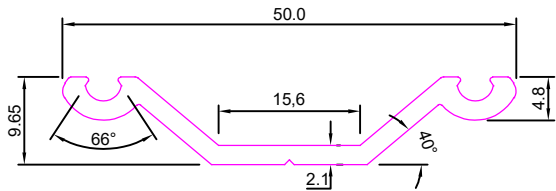

SEC. NO:-5891

Weight :- 2.060kg/12'

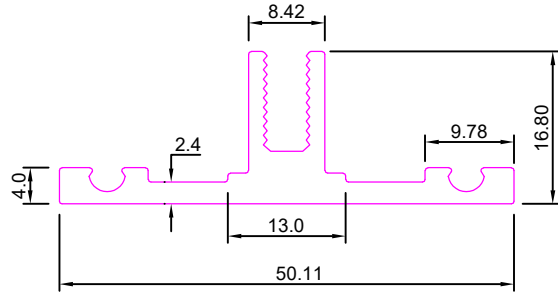

SEC. NO:- 6039

Weight :-8.100kg/12'

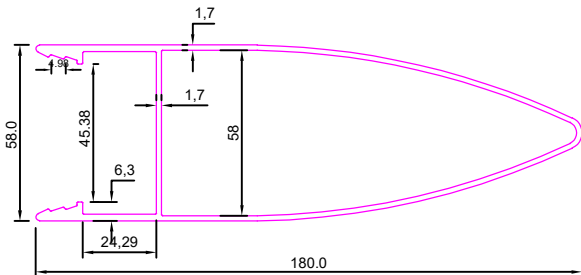

SEC. NO:- 6041

Weight :- 6.800kg/12'

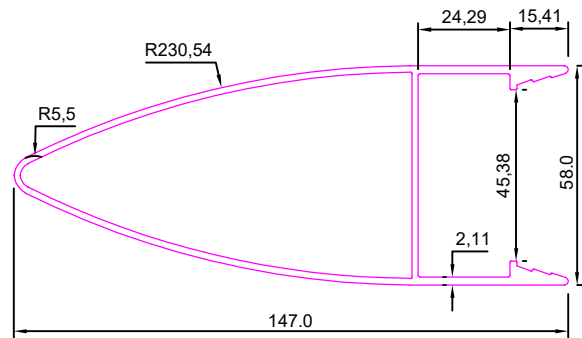

SEC. NO:-6075

Weight :- 2.825kg/12'

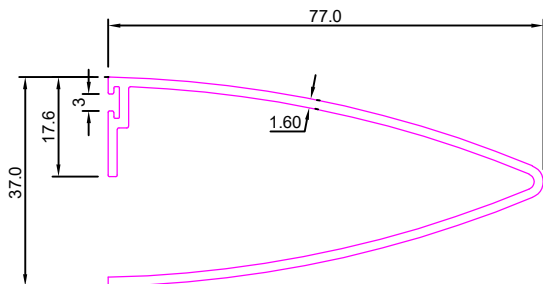

SEC. NO:-6077

Weight :- 3.195kg/12'

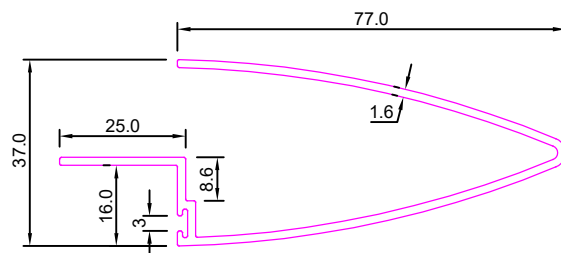



CURTAIN WALL

SEC No. 7138

Weight :-1.050kg/12'

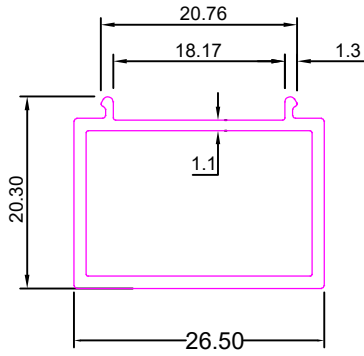

SEC No. 7179

Weight :-20.600kg/12'

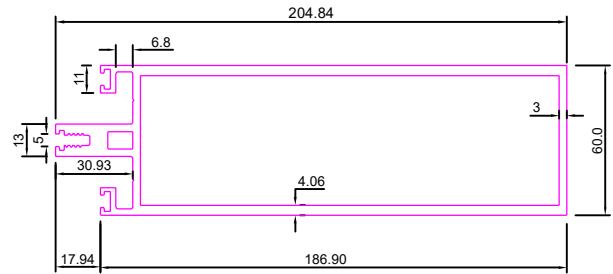

SEC No. 7261

Weight :-2.050kg/12'

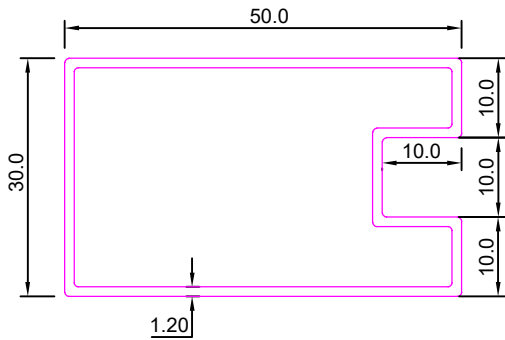

SEC No.7276

Weight :-0.450kg/12'

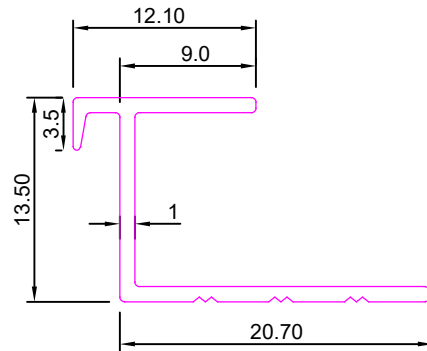

SEC No.7318

Weight :-6.900kg/12'

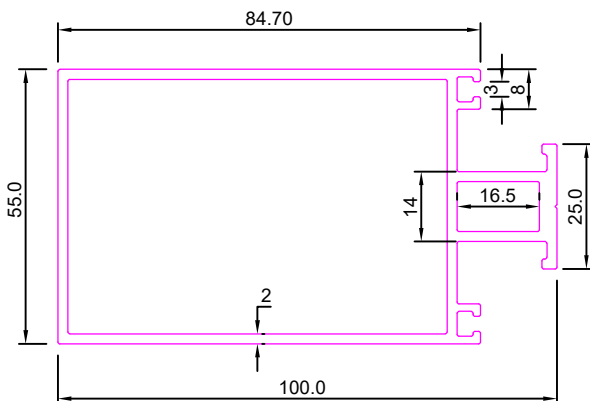

SEC No. 7355

Weight :-8.854kg/12'

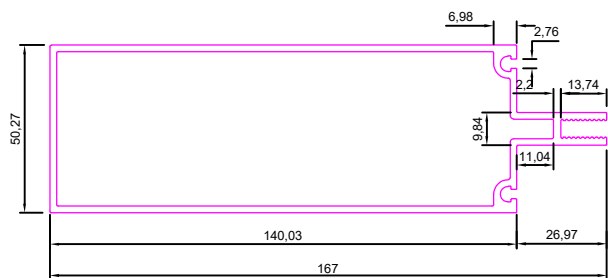



CURTAIN WALL

SEC No. 7356

Weight :-13.000kg/12'

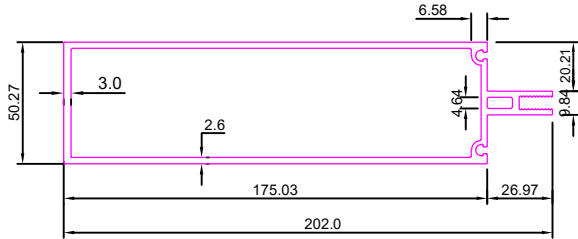

SEC No. 7357

Weight :-19.370kg/12'

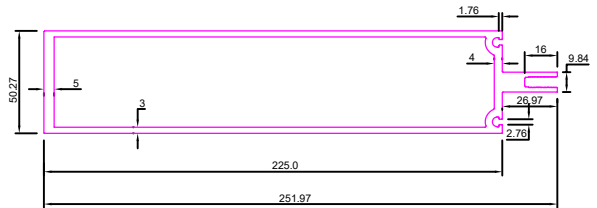

SEC No. 7366

Weight :-8.400kg/12'

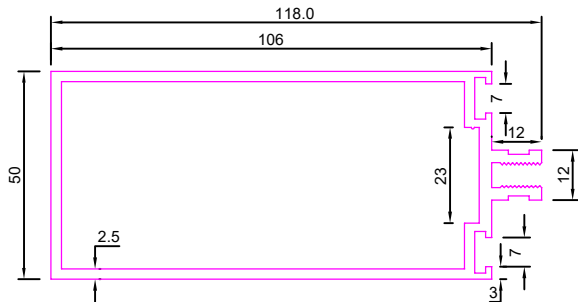

SEC No. 7367

Weight :-7.345kg/12'

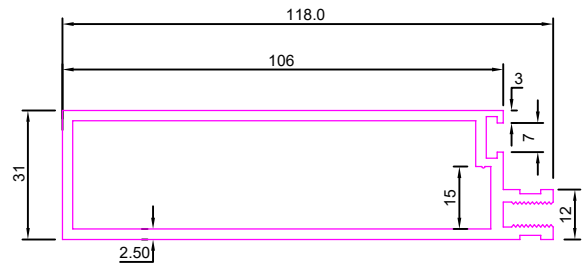

SEC No. 7386

Weight :-8.050kg/12'

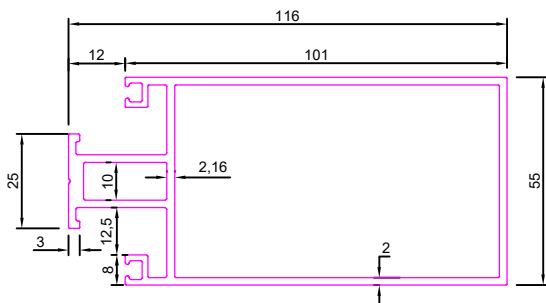

SEC No. 7424

Weight :-21.145kg/12'

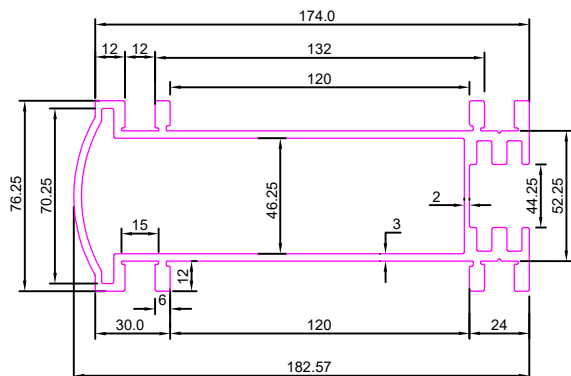



CURTAIN WALL

SEC No.7430

Weight :-13.050kg/12'

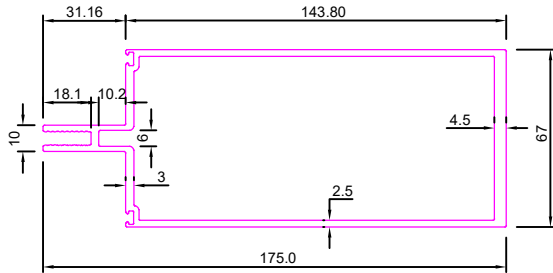

SEC No.7431

Weight :-12.810kg/12'

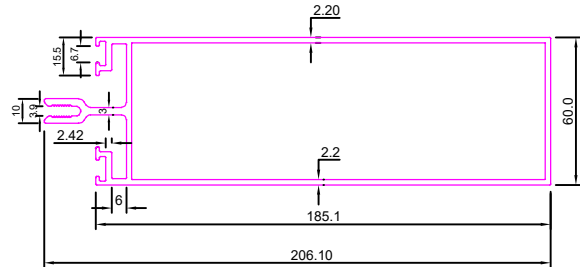

SEC No. 7455

Weight :- 21.600kg/12'

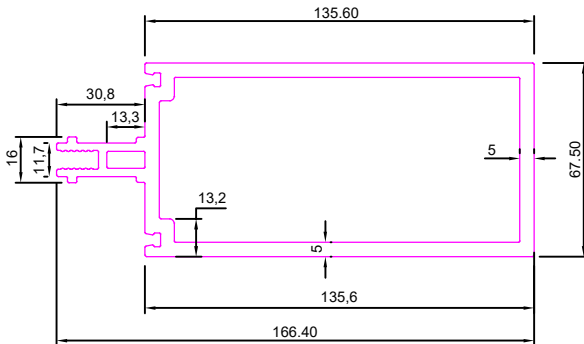

SEC No. 7473

Weight :- 12.600kg/12'

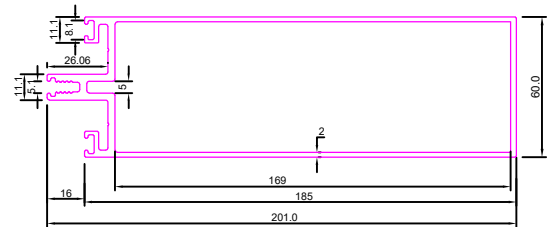

SEC No. 7474

Weight :- 8.900kg/12'

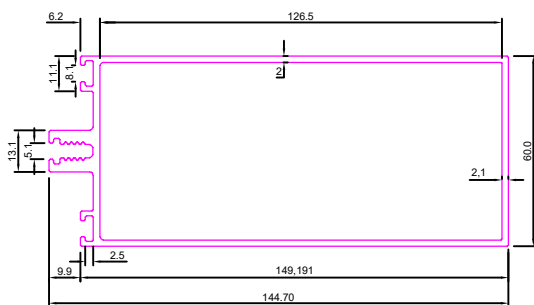

SEC No. 7475

Weight :-9.500kg/12'

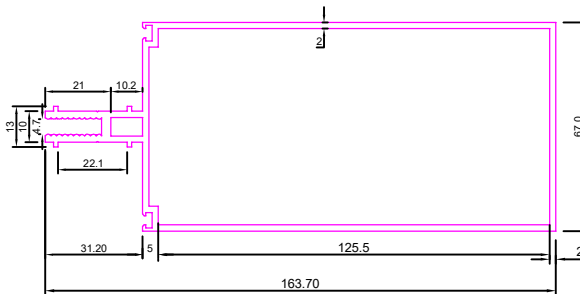



CURTAIN WALL

SEC No. 7476

Weight :- 13.750kg/12'

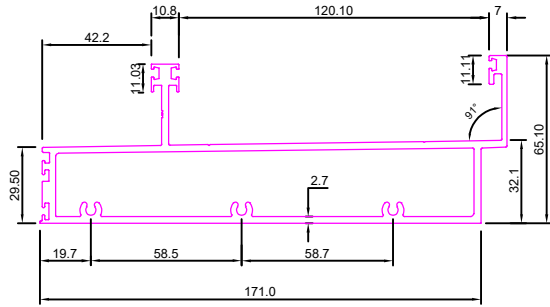

SEC No. 7477

Weight :-11.00kg/12'

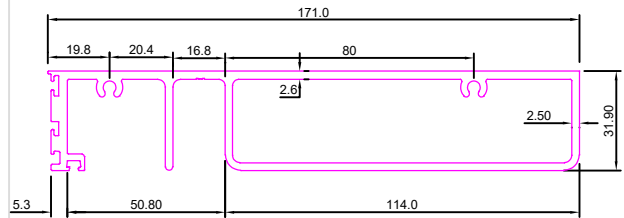

SEC No. 7480

Weight :-15.900kg/12'

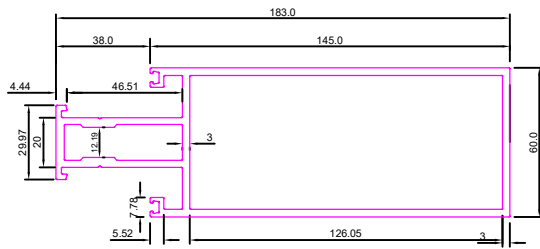

SEC No. 7481

Weight :-10.635kg/12'

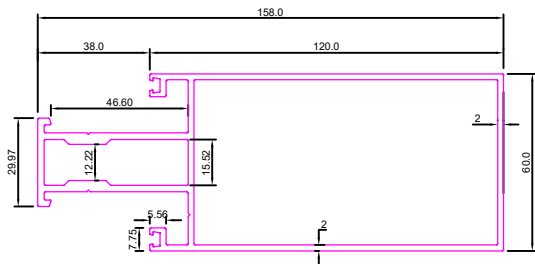

SEC No. 7482

Weight :-8.300kg/12'

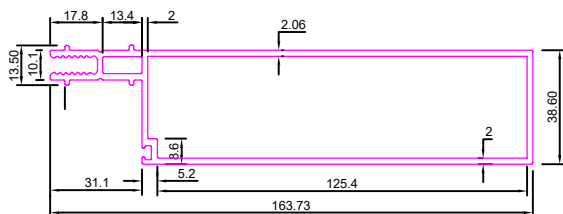

SEC. NO:-7523

Weight :- 10.200kg/12'

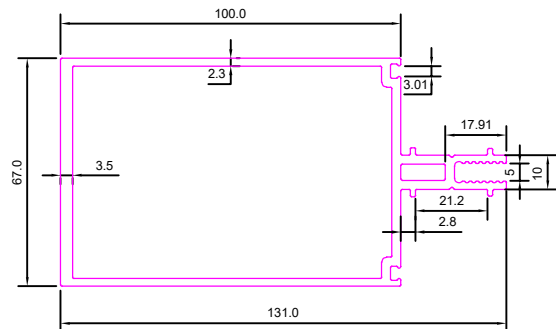



CURTAIN WALL

SEC. NO:-7533

Weight :- 8.800kg/12'

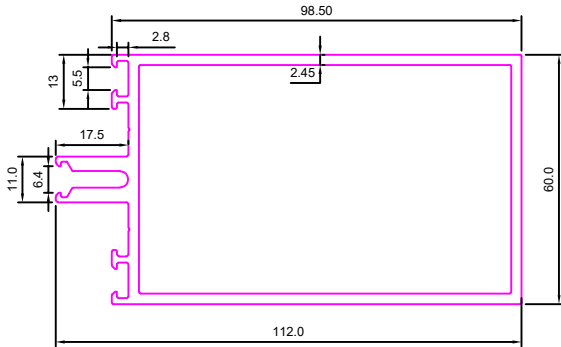

SEC. NO:-7538

Weight :- 5.518kg/12'

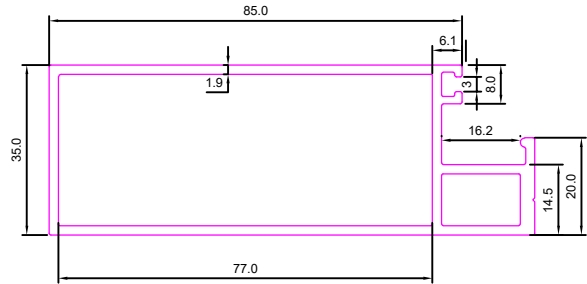

SEC. NO:-7545

Weight :- 6.118kg/12'

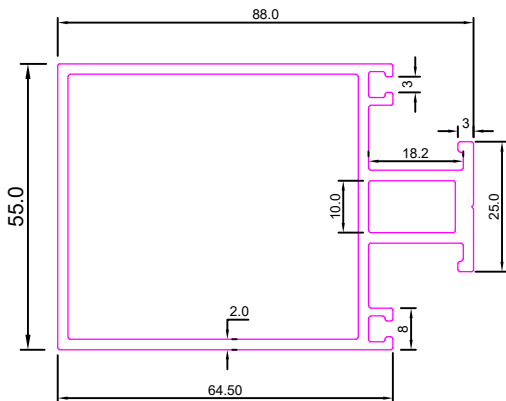

SEC. NO:-7549

Weight :- 7.667kg/12'

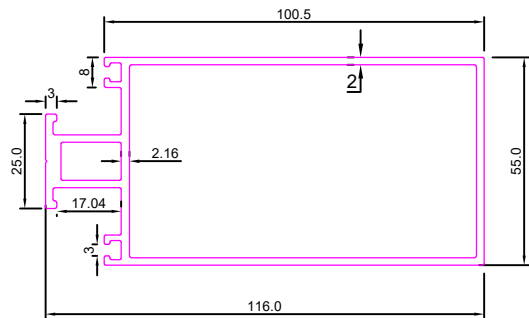

SEC. NO:-7569

Weight :-2.020kg/12'

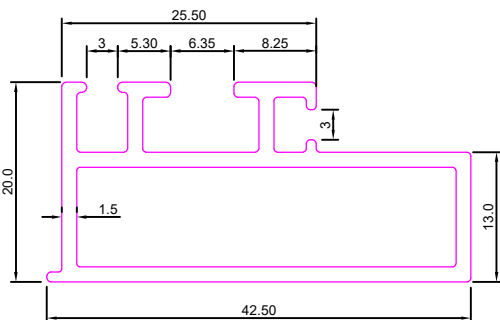

SEC No. 7596

Weight :-20.400kg/12'

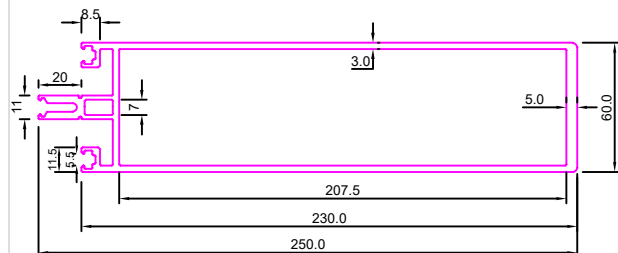



CURTAIN WALL

SEC No. 7605

Weight :- 3.350kg/12'

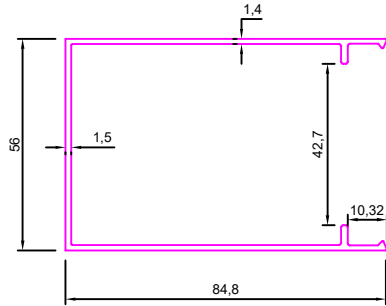

SEC No. 7606

Weight :- 1.340kg/12'

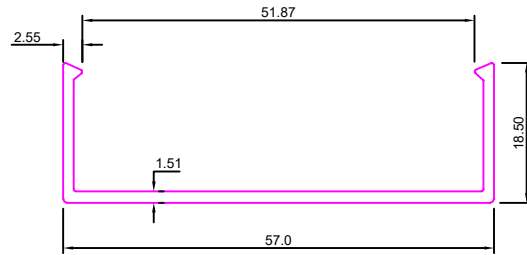

SEC No. 7607

Weight :- 1.550kg/12'

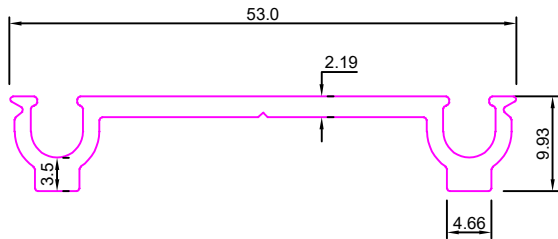

SEC No. 7609

Weight :-15.700kg/12'

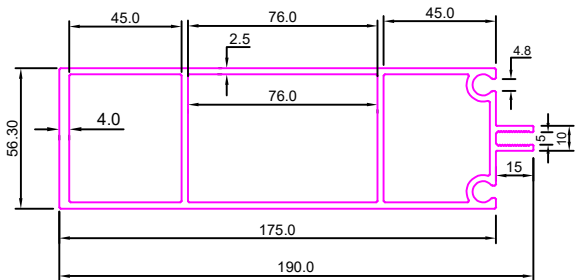

SEC No. 7610

Weight :-16.950kg/12'

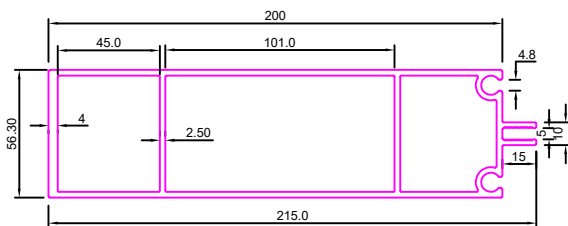

SEC No. 7619

Weight :-11.600kg/12'

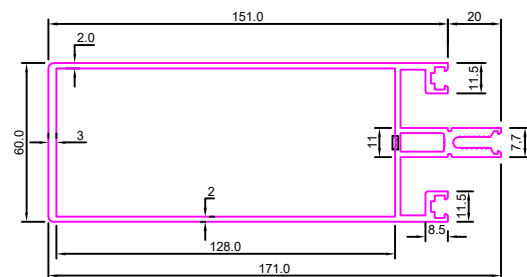



CURTAIN WALL

SEC No. 7621

Weight :-11.670kg/12'

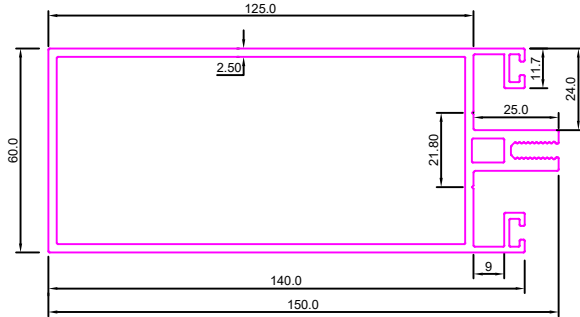

SEC No. 7631

Weight:-4.050Kg/12'

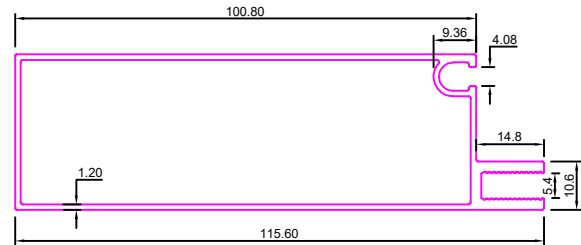

SEC No. 7646

Weight :-2.780kg/12'

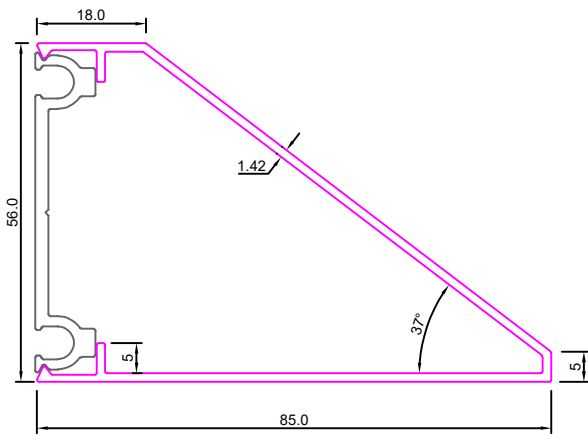

SEC No. 7706

Weight:-0.950Kg/12'

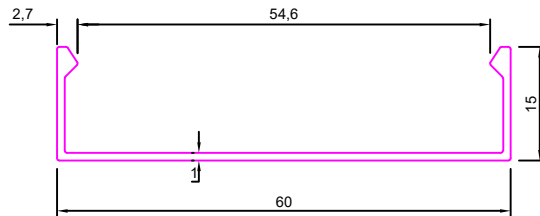

SEC No. 7707

Weight:-1.300Kg/12'

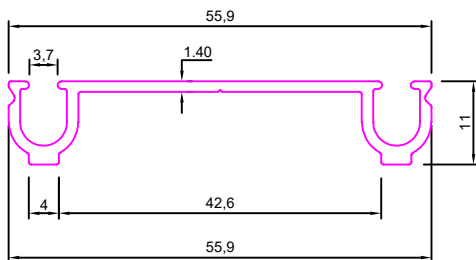

SEC No. 7737

Weight:-46.400Kg/12'

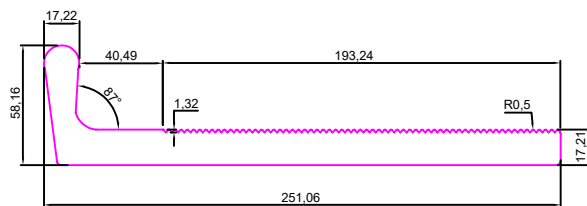



CURTAIN WALL

SEC No. 7740

Weight:-6.700Kg/12'

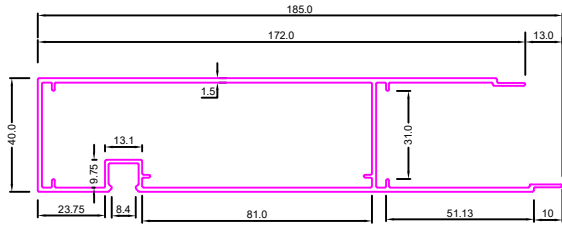

SEC No. 7745

Weight:-15.850Kg/12'

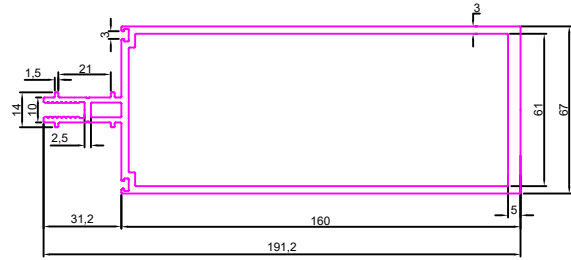

SEC No. 7755

Weight:-10.655Kg/12'

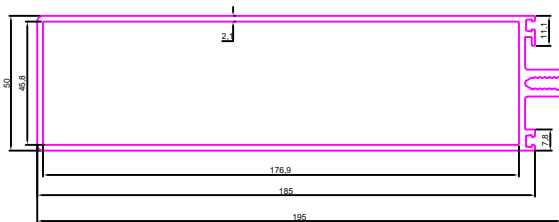

SEC No. 7758

Weight:-12.050Kg/12'

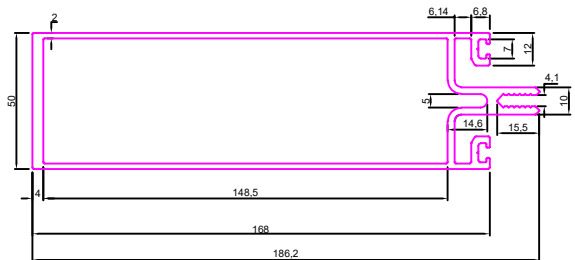

SEC No. 7760

Weight:-8.500Kg/12'

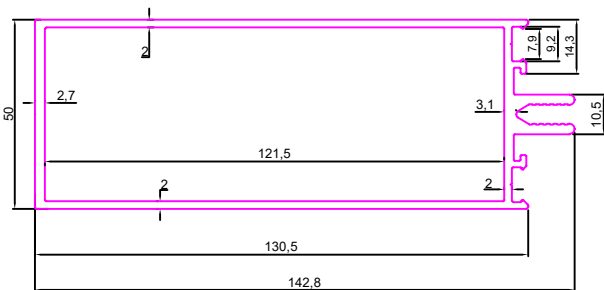

SEC No. 7771

Weight:-49.000Kg/12'

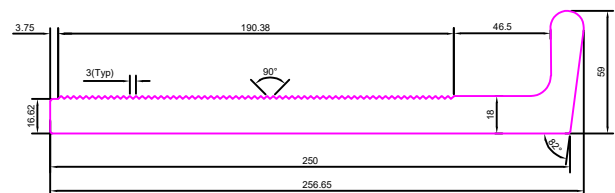



CURTAIN WALL

SEC No. 7772

Weight:-57.650Kg/12'

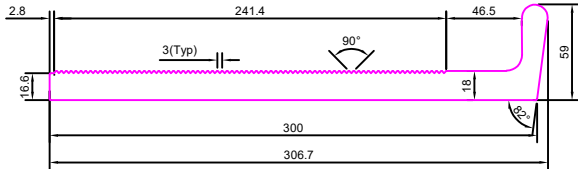

SEC No. 7790

Weight:-9.600Kg/12'

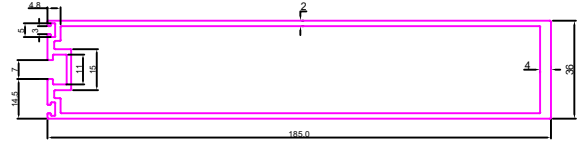

SEC No. 7817

Weight:-6.650Kg/12'

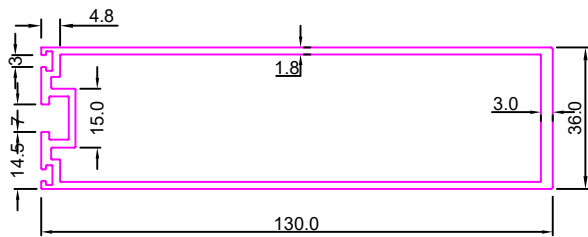

SEC No. 7842

Weight:-2.300Kg/12'

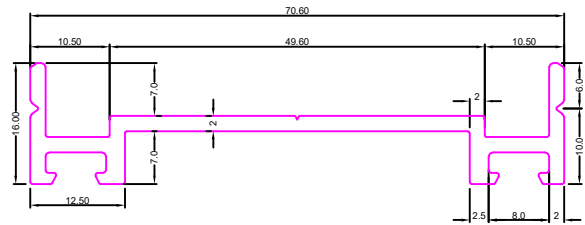

SEC No. 7843

Weight:-2.200Kg/12'

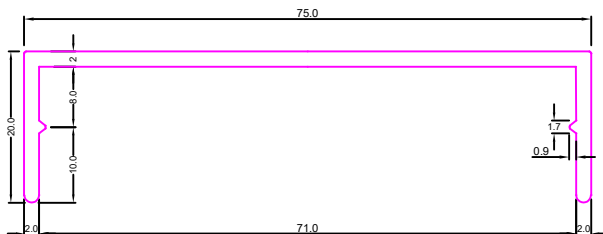

SEC No. 7844

Weight:-15.900Kg/12'

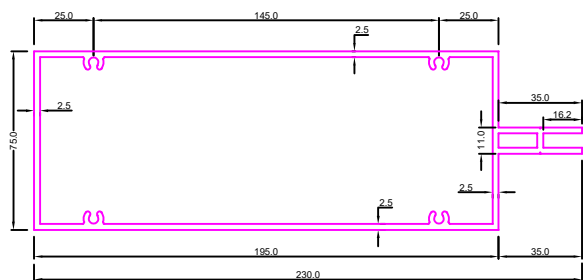



CURTAIN WALL

SEC No. 7845

Weight:-14.050Kg/12'

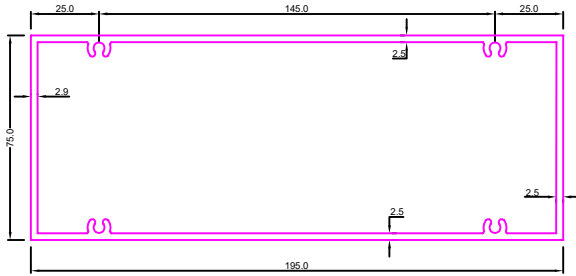

SEC No. 7850

Weight:-15.000Kg/12'

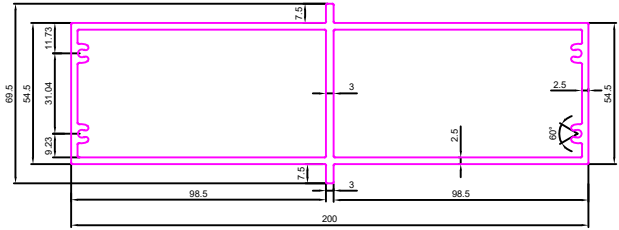

SEC No. 7869

Weight:9.600Kg/12'

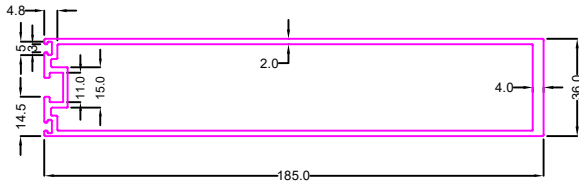

SEC No. 7870

Weight:10.450Kg/12'

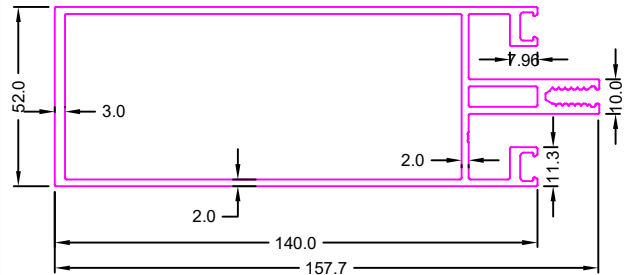

SEC No. 7871

Weight:9.135Kg/12'

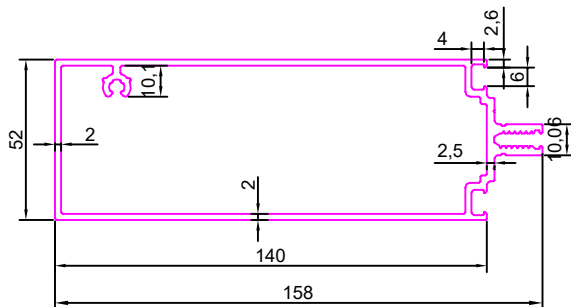

SEC No. 7872

Weight:7.600Kg/12'

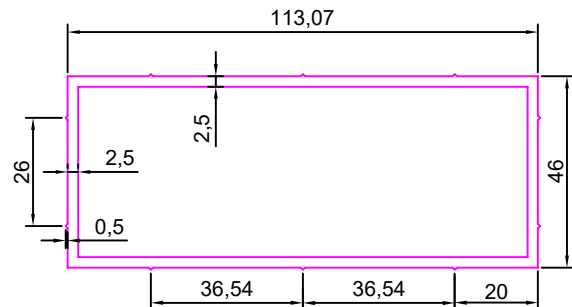



CURTAIN WALL

SEC No. 7873

Weight:1.400Kg/12'

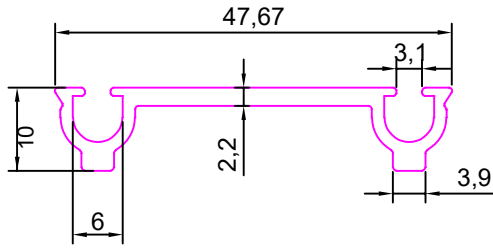

SEC No. 7874

Weight:1.400Kg/12'

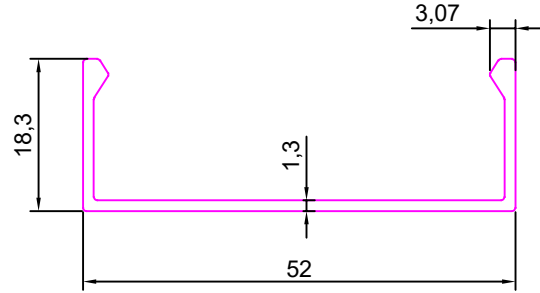

SEC No. 7875

Weight:5.000Kg/12'

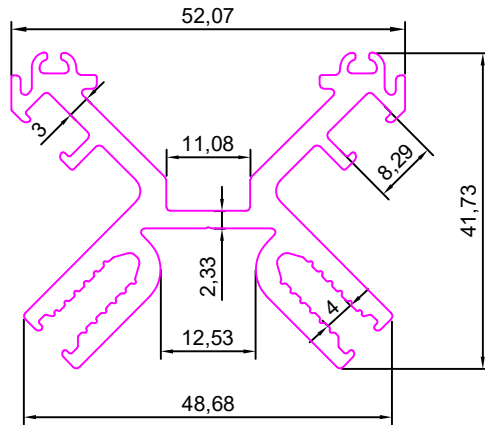

SEC No. 7879

Weight:12.195Kg/12'

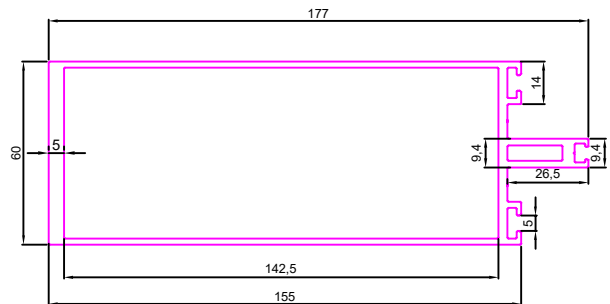

SEC No. MA7888

Weight:-10.625Kg/12'

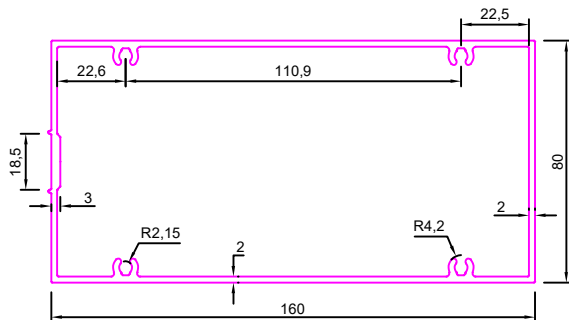

SEC No. 8041

Weight:-9.200Kg/12'

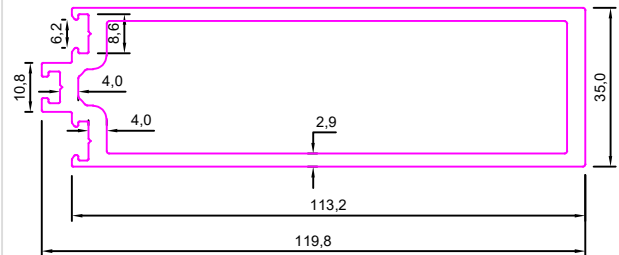



CURTAIN WALL

SEC No. 8042

Weight:-0.880Kg/12'

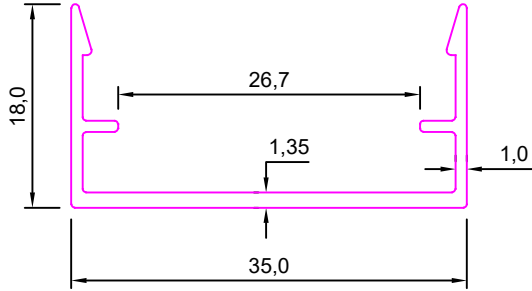

SEC No. 8043

Weight:-1.200Kg/12'

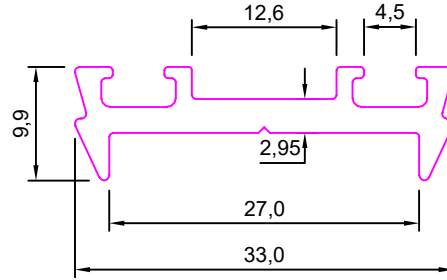

SEC No:-GA8079

Weight:-10.100Kg/12'

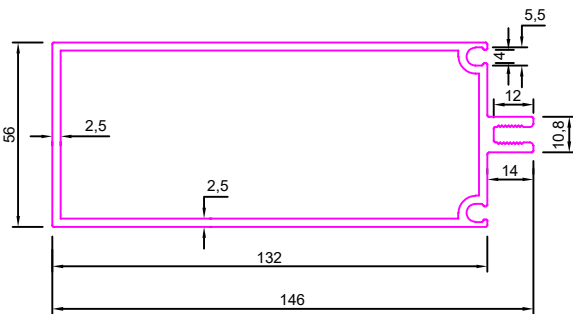

SEC No:-8099

Weight:-5.750Kg/12'

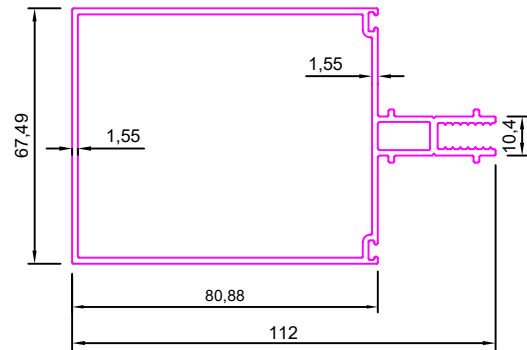

SEC No:-8100

Weight:-4.800Kg/12'

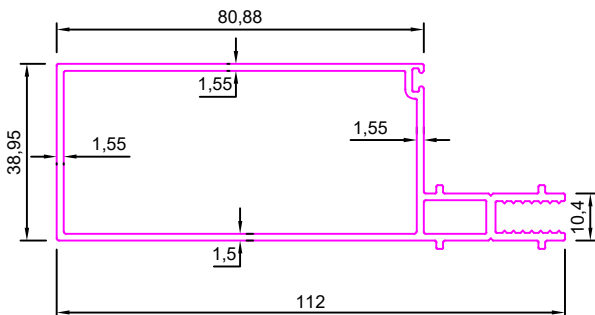

SEC No:- GA8106

Weight:-8.570Kg/12'

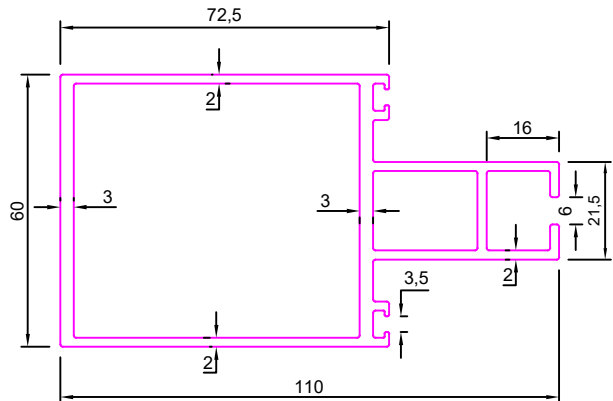



CURTAIN WALL

SEC No:- VA8117

Weight:-1.970Kg/12'

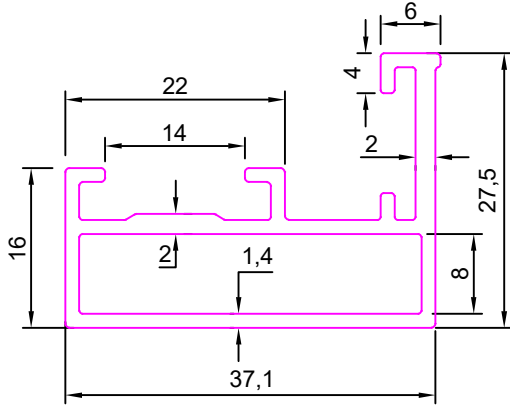

SEC No:- VA8118

Weight:-8.880Kg/12'

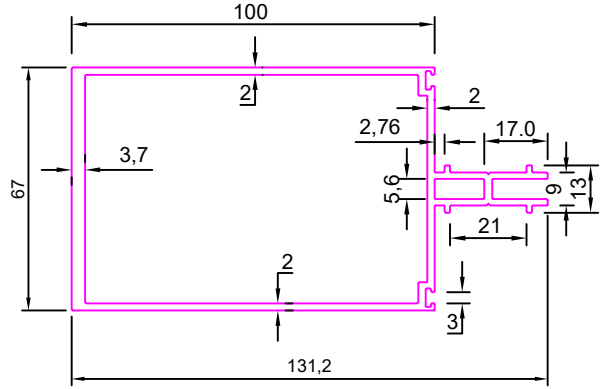

SEC No:- VA8119

Weight:-6.920Kg/12'

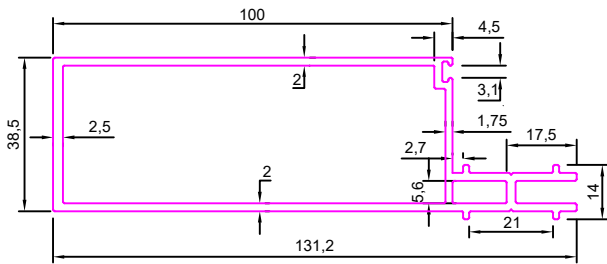

SEC No:- MA8120

Weight:-9.650Kg/12'

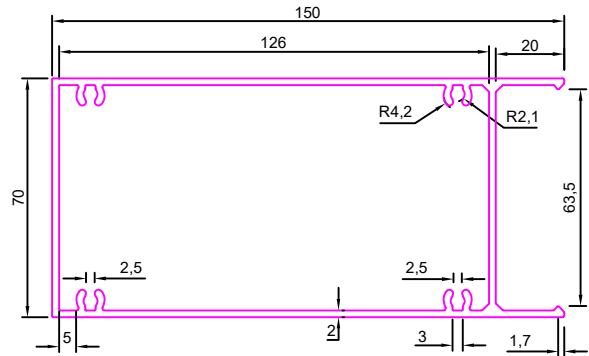

SEC No:- VA8121

Weight:-3.050Kg/12'

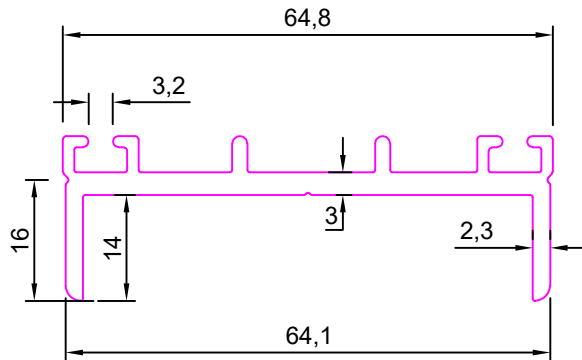

SEC No:- VA8122

Weight:-5.980Kg/12'

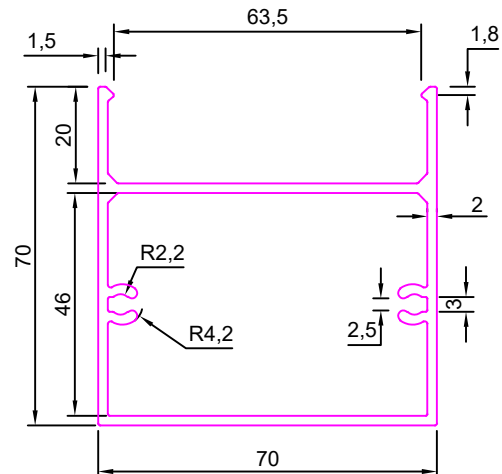



CURTAIN WALL

SEC No. 8141

Weight:-0.690Kg/12'

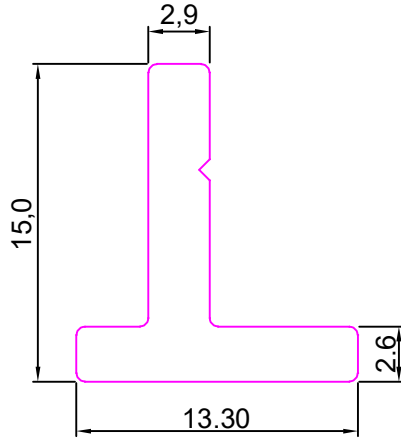

SEC No. :-8287

Weight:-12.700Kg/12'

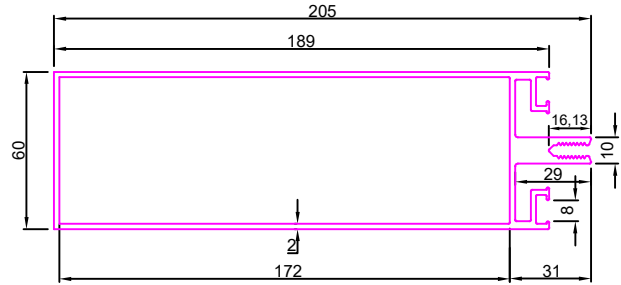

SEC No. 8333

Weight:-7.450Kg/12'

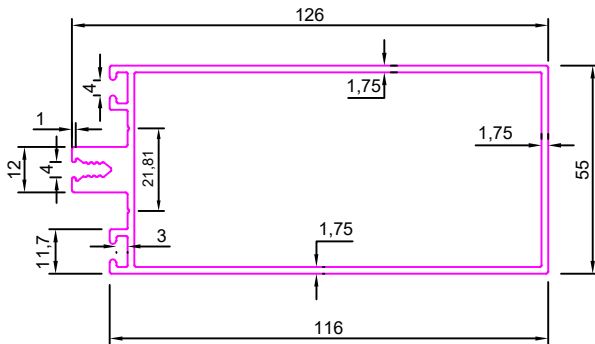

SEC No. 8344

Weight:-9.100Kg/12'

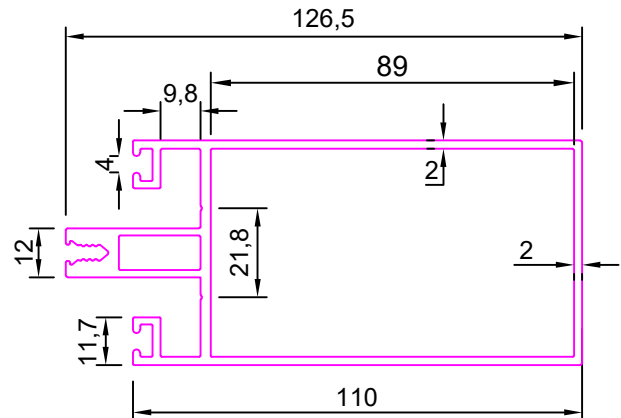

SEC No. MA8345

Weight:-6.300Kg/12'

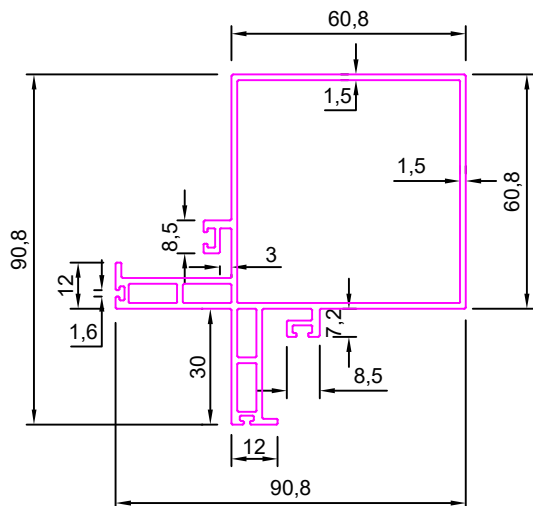

SEC No. MA8502

Weight:-10.150Kg/12'

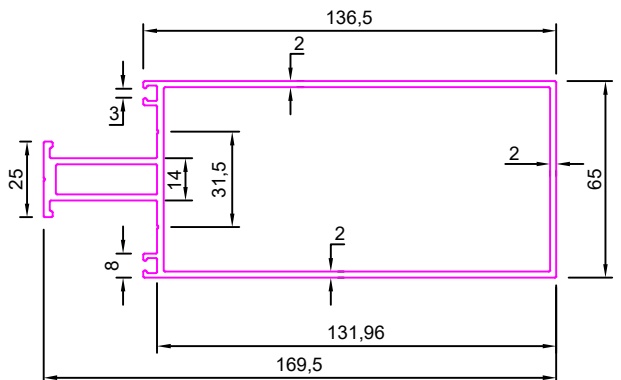



CURTAIN WALL

SEC No. MA8503

Weight:-12.950Kg/12'

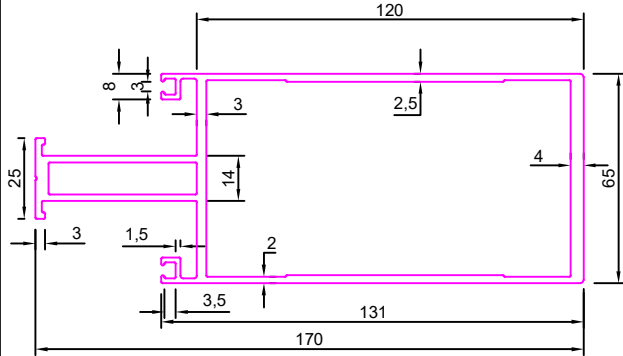

SEC No. 8563

Weight:22.060Kg/12'

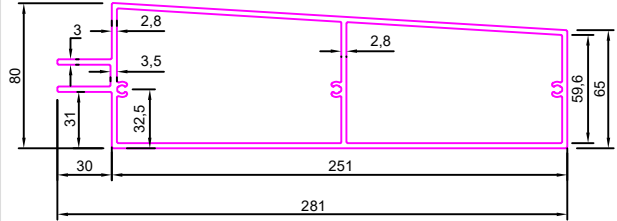

SEC No. 8564

Weight:21.430Kg/12'

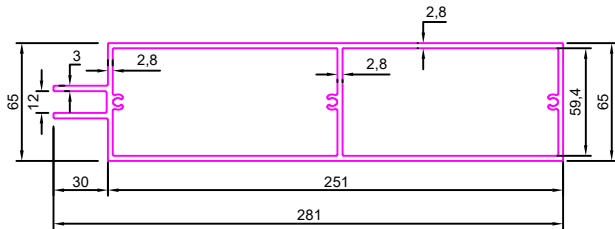

SEC No. 8581

Weight:16.575Kg/12'

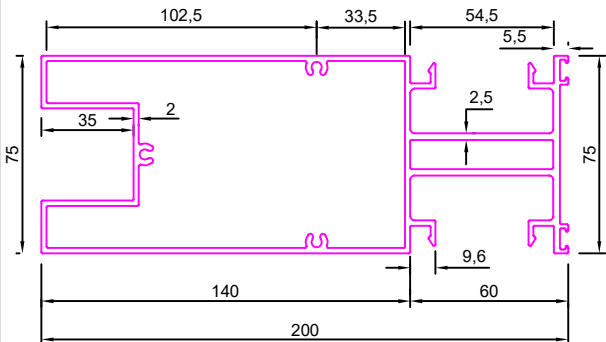

SEC No. 8605

Weight:13.690Kg/12'

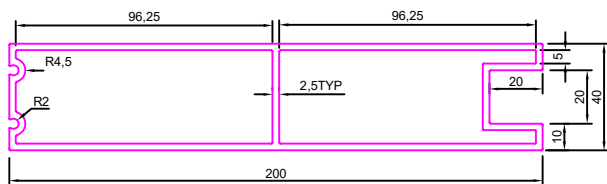

SEC No. 8607

Weight:2.000Kg/12'

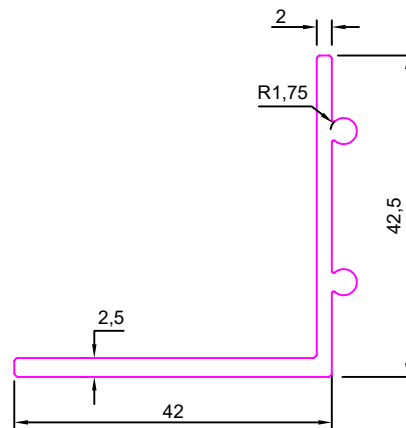



CURTAIN WALL

SEC No. 8627

Weight:10.300Kg/12'

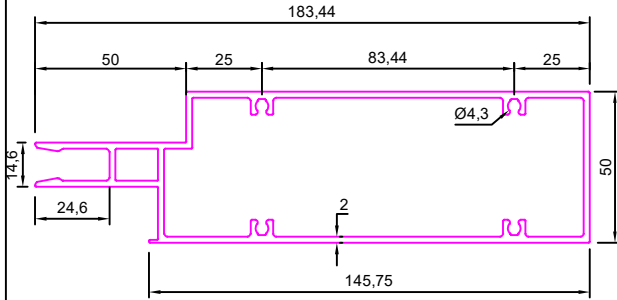

SEC No. 8665

Weight:1.040Kg/12'

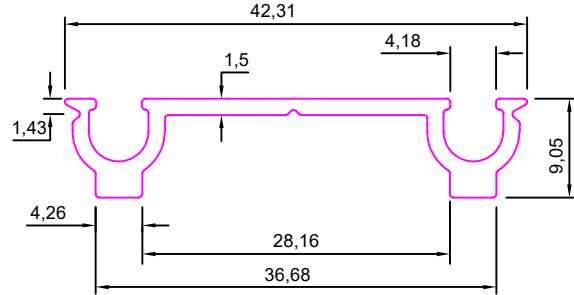

SEC No.:- 8759

Weight:-12.600Kg/12'

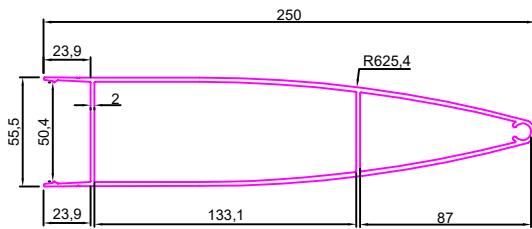

SEC No.:- 8760

Weight:-2.650Kg/12'

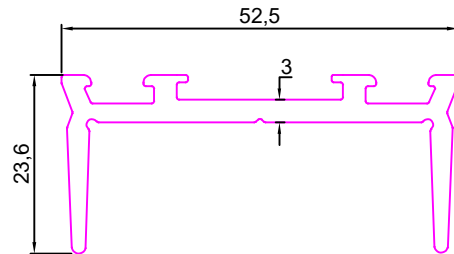

SEC No.:- 8761

Weight:-5.850Kg/12'

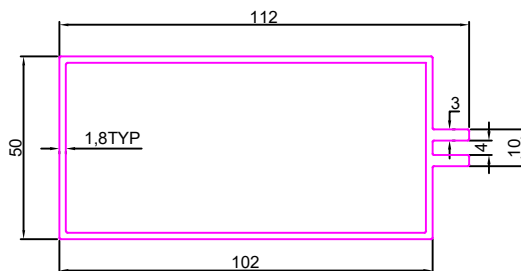

SEC No.:- 8762

Weight:-4.625Kg/12'

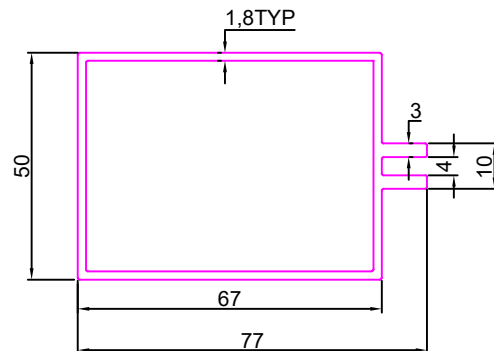



CURTAIN WALL

SEC No.:- 8763

Weight:-2.850Kg/12'

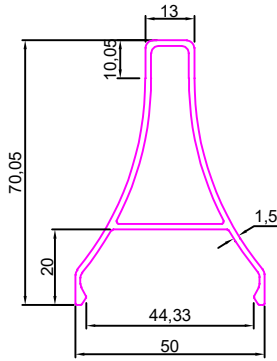

SEC No.:- 8764

Weight:-3.515Kg/12'

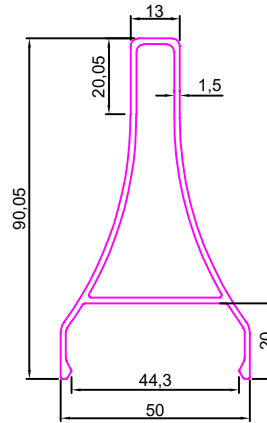

SEC No.:- 8765

Weight:-1.160Kg/12'

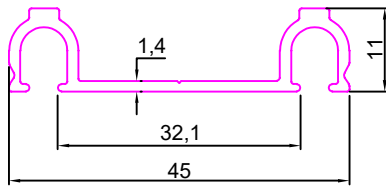

SEC No.:- 8766

Weight:-4.240Kg/12'

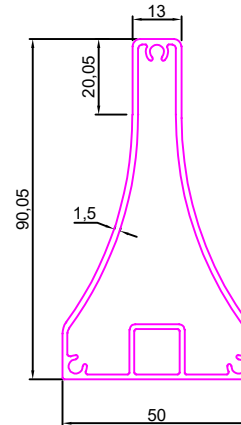

SEC No.:- SA8784

Weight:-23.500Kg/12'

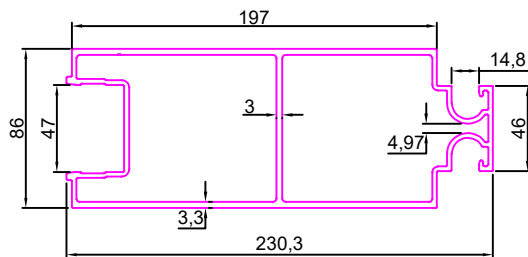

SEC No.:-GA8798

Weight:-10.700Kg/12'

